

NFPA 13
Standard for the
Installation of Sprinkler Systems
2007 Edition

Copyright © 2006 National Fire Protection Association. All Rights Reserved.

This edition of NFPA 13, *Standard for the Installation of Sprinkler Systems*, was prepared by the Technical Committee on Hanging and Bracing of Water-Based Fire Protection Systems, the Technical Committee on Private Water Supply Piping Systems, the Technical Committee on Residential Sprinkler Systems, the Technical Committee on Sprinkler System Discharge Criteria, and the Technical Committee on Sprinkler System Installation Criteria, released by the Technical Correlating Committee on Automatic Sprinkler Systems, and acted on by NFPA at its June Association Technical Meeting held June 4–8, 2006, in Orlando, FL. It was issued by the Standards Council on July 28, 2006, with an effective date of August 17, 2006, and supersedes all previous editions.

A tentative interim amendment (TIA) to Section 7.2.3 was issued on July 28, 2006. For further information on tentative interim amendments see Section 5 of the NFPA Regulations Governing Committee Projects available at:

<http://www.nfpa.org/assets/files/PDF/CodeStandards/TIAErrataFI/TIAREgs.pdf>

This edition of NFPA 13 was approved as an American National Standard on August 17, 2006.

Origin and Development of NFPA 13

NFPA 13 represents the first standard published under the auspices of the NFPA Committee on Automatic Sprinklers. Originally titled *Rules and Regulations of the National Board of Fire Underwriters for Sprinkler Equipments, Automatic and Open Systems*, the standard has been continuously updated to keep in step with change.

Full information about the NFPA actions on various changes will be found in the NFPA Proceedings. The dates of successive editions are as follows: 1896, 1899, 1902, 1905, 1907, 1908, 1912, 1913, 1915, 1916, 1917, 1919, 1920, 1921, 1922, 1923, 1924, 1925, 1926, 1927, 1928, 1929. In 1930, a separate standard was published on Class B systems. This was integrated into the 1931 edition. Further revisions were adopted in 1934, 1935, and 1936. A two-step revision was presented in the form of a progress report in 1939 and finally adopted

Copyright NFPA

in 1940. Further amendments were made in 1947, 1950, 1953, 1956, 1958, 1960, 1961, 1963, 1964, 1965, 1966, 1968, 1969, 1971, 1972, 1973, 1974, 1975, 1976, 1978, 1980, 1982, 1984, 1986, and 1989.

The 1991 edition incorporated an entire rewrite of the standard to make the overall format user friendly. Substantive changes were made to numerous terms, definitions, and descriptions, with additional refinements made in 1994.

The centennial (1996) edition included a significant rework of the requirements pertaining to the application, placement, location, spacing, and use of various types of sprinklers. Other changes provided information on extended coverage sprinklers and recognized the benefits of fast-response sprinkler technology.

The 1999 edition encompassed a major reorganization of NFPA's Sprinkler Project that included the establishment of a Technical Correlating Committee on Automatic Sprinkler Systems and four new sprinkler systems technical committees, the consolidation of NFPA's sprinkler system design and installation requirements, and the implementation of numerous technical changes.

The scope of NFPA 13 was expanded to address all sprinkler system applications. The 1999 edition contained information on the installation of underground pipe from NFPA 24 and sprinkler system discharge criteria for on-floor and rack storage of Class I, II, III, IV, and plastic commodities, rubber tires, baled cotton, and roll paper that were previously located in NFPA 231, 231C, 231D, 231E, and 231F. Additionally, sprinkler system information for specialized hazards from over 40 NFPA documents was either copied into NFPA 13 using NFPA's extract policy or specifically referenced. A new chapter was also added to address the structural aspects of exposed and buried system piping. A table of cross-references to previous editions and material that was located in other NFPA documents was included at the end of the 1999 edition.

More specific changes included a new sprinkler identification marking system and the designation of sprinkler sizes by nominal K-factors. New criteria for the use of steel pipe in underground applications was added, as well as a new provision to guard against microbiologically influenced corrosion. Obstruction rules for specific sprinkler types and rules for locating sprinklers in concealed spaces were revised. New limitations were placed on the sprinkler sizes in storage applications, and criteria for the K-25 sprinkler was added. Additionally, the requirements for protecting sprinklers against seismic events also underwent significant revision.

The 2002 edition of NFPA 13 underwent style formatting and technical revisions. The style formatting was completed to comply with the *Manual of Style for NFPA Technical Committee Documents* and to reorganize many of the requirements in NFPA 13 into unique chapters. Editorially, NFPA 13 eliminated all of the exceptions and reworded them as requirements where applicable, moved the mandatory references to Chapter 2, and relocated all of the definitions to Chapter 3. In reorganizing NFPA 13, several new chapters were created to consolidate requirements including the following: Chapter 10 contained all of the applicable requirements for underground piping including materials, installation, and acceptance testing; Chapter 11 contained design approaches including pipe schedule, density-area method, room design method, special design areas, residential sprinklers,

Copyright NFPA

exposure protection, and water curtains; Chapter 12 contained the design approaches for the protection of storage, including idle pallets, miscellaneous storage, storage less than 12 ft, palletized, solid pile, bin box, and shelf storage, rack storage less than 25 ft, rack storage greater than 25 ft, rubber tire, baled cotton, rolled paper, and special storage designs; Chapter 13 contained all of the design and installation requirements from all of the various documents that have been extracted into NFPA 13.

The 2002 edition made specific technical changes to address several key issues. Three major areas of irregular ceiling were addressed, including skylights, stepped ceilings, and ceiling pockets. The design requirements for ESFR sprinklers were expanded to allow the user to choose the storage height and then the building height for any allowable arrangement. Design requirements for the protection of storage on solid shelves were added. Requirements for the installation of residential sprinklers were added that parallel the requirements for other types of sprinklers.

For the 2007 edition, definitions were reorganized to locate all of the storage definitions in one area, and several new definitions addressing private water supply terms were added. The definitions and requirements of Ordinary Hazard Group 1 and 2 Occupancies were clarified where storage is present. The requirements for trapeze hangers were clarified and made consistent for all components, and the seismic bracing criteria were updated to ensure that NFPA 13 contains all of the appropriate requirements for installation and design of seismic bracing of fire sprinkler systems. The requirements for storage were further reorganized and divided into separate chapters addressing General Requirements for Storage, Miscellaneous Storage, Protection of Class I to Class IV Commodities that are Stored Palletized, Solid Piled, Bin Boxes, or Self Storage, Protection of Plastic and Rubber Commodities That Are Stored Palletized, Solid Piled, Bin Boxes, or Shelf Storage, Protection of Class I through Class IV Commodities That Are Stored on Racks, Protection of Plastic and Rubber Commodities That Are Stored on Racks, Protection of Rubber Tire Storage, Protection of Roll Paper, and Special Designs of Storage Protection.

Prior editions of this document have been translated into languages other than English, including French and Spanish.

Technical Correlating Committee on Automatic Sprinkler Systems (AUT-AAC)

John G. O'Neill, *Chair*

The Protection Engineering Group, PC, VA [SE]

Christian Dubay, *Nonvoting Secretary*

National Fire Protection Association, MA

Jose R. Baz, International Engineered Systems Limited, Incorporated, FL [M]
Rep. NFPA Latin American Section

Kerry M. Bell, Underwriters Laboratories Incorporated, IL [RT]

Russell P. Fleming, National Fire Sprinkler Association, NY [M]

Copyright NFPA

Scott T. Franson, The Viking Corporation, MI [M]

James B. Harmes, Grand Blanc Fire Department, MI [E]
Rep. International Association of Fire Chiefs

Luke Hilton, Liberty Mutual Property, NC [I]

Alex Hoffman, Viking Fire Protection Incorporated, Canada [IM]
Rep. Canadian Automatic Sprinkler Association

Roland J. Huggins, American Fire Sprinkler Association, Incorporated, TX [IM]

Sultan M. Javeri, SC Engineering, France [IM]

Andrew Kim, National Research Council of Canada, Canada [RT]

Donald C. Moeller, The RJA Group, Incorporated, CA [SE]

Joe W. Noble, Clark County Fire Department, NV [E]
Rep. International Fire Marshals Association

Eric Packard, Local 669 JATC Education Fund, MD [L]
Rep. United Association of Journeymen and Apprentices of the Plumbing & Pipe Fitting Industry of the US & Canada

Chester W. Schirmer, Schirmer Engineering Corporation, NC [SE]

Robert D. Spaulding, FM Global, MA [I]

Lynn K. Underwood, Axis US Property, IL [I]

Alternates

Donald “Don” D. Becker, RJC & Associates, Incorporated, MO [IM]
(Alt. to Roland J. Huggins)

Thomas C. Brown, The RJA Group, Incorporated, MD [SE]
(Alt. to Donald C. Moeller)

George Capko, Jr., FM Global, MA [I]
(Alt. to Robert D. Spaulding)

Kenneth E. Isman, National Fire Sprinkler Association, NY [M]
(Alt. to Russell P. Fleming)

George E. Laverick, Underwriters Laboratories Incorporated, IL [RT]

Copyright NFPA

(Alt. to Kerry M. Bell)

Garner A. Palenske, Schirmer Engineering Corporation, CA [I]

(Alt. to Chester W. Schirmer)

Donato A. Pirro, Electro Sistemas De Panama. S.A., Panama [M]

(Alt. to Jose R. Baz)

J. Michael Thompson, The Protection Engineering Group, PC, VA [SE]

(Alt. to John G. O'Neill)

Nonvoting

Antonio C. M. Braga, FM Global, CA [I]

Rep. TC on Hanging & Bracing of Water-Based Systems

Edward K. Budnick, Hughes Associates, Incorporated, MD [SE]

Rep. TC on Sprinkler System Discharge Criteria

Robert M. Gagnon, Gagnon Engineering, MD [SE]

Rep. TC on Foam-Water Sprinklers

William E. Koffel, Koffel Associates, Incorporated, MD [SE]

Rep. Safety to Life Correlating Committee

Kenneth W. Linder, GE Insurance Solutions, CT [I]

Rep. TC on Sprinkler System Installation Criteria

Daniel Madrzykowski, U.S. National Institute of Standards & Technology, MD [RT]

Rep. TC on Residential Sprinkler Systems

J. William Sheppard, General Motors Corporation, MI [U]

Rep. TC on Private Water Supply Piping Systems

John J. Walsh, UA Joint Apprenticeship Committee, MD [SE]

(Member Emeritus)

Christian Dubay, NFPA Staff Liaison

This list represents the membership at the time the Committee was balloted on the final text of this edition. Since that time, changes in the membership may have occurred. A key to classifications is found at the back of the document.

NOTE: Membership on a committee shall not in and of itself constitute an endorsement of the Association or any document developed by the committee on which the member serves.

Committee Scope: This Committee shall have overall responsibility for documents that pertain to the criteria for the design and installation of automatic, open, and foam-water sprinkler systems including the character and adequacy of water supplies and the selection of

Copyright NFPA

sprinklers, piping, valves, and all materials and accessories. This Committee does not cover the installation of tanks and towers, or the installation, maintenance, and use of central station, proprietary, auxiliary, and local signaling systems for watchmen, fire alarm, and supervisory service, or the design of fire department hose connections.

Technical Committee on Hanging and Bracing of Water-Based Fire Protection Systems

Antonio C. M. Braga, *Chair*
FM Global, CA [I]

Christian Dubay, *Nonvoting Secretary*
National Fire Protection Association, MA

James B. Biggins, Marsh Risk Consulting, IL [I]

Richard W. Bonds, Ductile Iron Pipe Research Association, AL [M]

Samuel S. Dannaway, S. S. Dannaway Associates, Incorporated, HI [SE]

Daniel C. Duggan, Fire Sprinkler Design, MO [M]

Thomas J. Forsythe, Hughes Associates, Incorporated, CA [SE]

John D. Gillengerten, State of California, CA [E]
Rep. Building Seismic Safety Council/Code Resource Support Committee

Luke Hilton, Liberty Mutual Property, NC [I]
Rep. Property Casualty Insurers Association of America

Terry Holst, Tyco/Grinnell Fire Protection Systems Co., CA [M]
Rep. National Fire Sprinkler Association

Tina Marie King, GE Insurance Solutions, CA [I]

Kraig Kirschner, AFCON, CA [M]

Alan R. Laguna, Merit Sprinkler Company, Incorporated, LA [IM]

George E. Laverick, Underwriters Laboratories Incorporated, IL [RT]

Philip D. LeGrone, Risk Management Solutions, Incorporated, TN [SE]

Norman J. MacDonald, III, FlexHead Industries, Incorporated, MA [M]

Wayne M. Martin, Wayne Martin & Associates Incorporated. (WMA), CA [SE]

J. Scott Mitchell, American Fire Sprinkler Association, TX [M]

Donald C. Moeller, The RJA Group, Incorporated, CA [SE]

David S. Mowrer, HSB Professional Loss Control, TN [I]

Randy R. Nelson, PE, VFS Fire & Security Services, CA [IM]
Rep. American Fire Sprinkler Association

Janak B. Patel, Bechtel Savannah River Company, GA [U]

Michael A. Rothmier, UA Joint Apprenticeship Committee, CO [L]
Rep. United Association of Journeymen & Apprentices of the Plumbing & Pipe Fitting
Industry of the US & Canada

James Tauby, Mason Industries, Incorporated, NY [M]

Jack W. Thacker, Allan Automatic Sprinkler Corp. of So. California, CA [IM]
Rep. National Fire Sprinkler Association

Victoria B. Valentine, National Fire Sprinkler Association, NY [M]

Alternates

Charles Bamford, Bamford Incorporated, WA [IM]
(Alt. to Randy R. Nelson, PE)

Sheldon Dacus, Security Fire Protection Company, TN [M]
(Alt. to Victoria B. Valentine)

Christopher I. Deneff, FM Global, RI [I]
(Alt. to Antonio C. M. Braga)

Todd A. Dillon, GE Insurance Solutions, OH [I]
(Alt. to Tina Marie King)

Russell G. Hoeltzel, Marsh Risk Consulting, CA [I]
(Alt. to James B. Biggins)

Michael J. Madden, Hughes Associates, Incorporated, CA [SE]
(Alt. to Thomas J. Forsythe)

Tracy Madjerich, ERICO, Incorporated, OH [M]
(Alt. to J. Scott Mitchell)

Emil W. Misichko, Underwriters Laboratories Incorporated, IL [RT]

Copyright NFPA

(Alt. to George E. Laverick)

Eric Packard, Local 669 JATC Education Fund, MD [L]

(Alt. to Michael A. Rothmier)

Glenn E. Thompson, Liberty Mutual Property, CA [I]

(Alt. to Luke Hilton)

Allyn J. Vaughn, The RJA Group, Incorporated, NV [SE]

(Alt. to Donald C. Moeller)

George Von Gnatensky, Tolco, CA [M]

(Alt. to Terry Holst)

Ronald N. Webb, S.A. Comunale Company, Incorporated, OH [IM]

(Alt. to Jack W. Thacker)

Christian Dubay, NFPA Staff Liaison

This list represents the membership at the time the Committee was balloted on the final text of this edition. Since that time, changes in the membership may have occurred. A key to classifications is found at the back of the document .

NOTE: Membership on a committee shall not in and of itself constitute an endorsement of the Association or any document developed by the committee on which the member serves.

Committee Scope: This Committee shall have the primary responsibility for those portions of NFPA 13 that pertain to the criteria for the use and installation of components and devices used for the support of water-based fire protection system piping including protection against seismic events.

Technical Committee on Private Water Supply Piping Systems

J. William Sheppard, *Chair*

General Motors Corporation, MI [U]

Rep. NFPA Industrial Fire Protection Section

James B. Biggins, Marsh Risk Consulting, IL [I]

Richard W. Bonds, Ductile Iron Pipe Research Association, AL [M]

Phillip A. Brown, American Fire Sprinkler Association, Incorporated, TX [IM]

Rep. American Fire Sprinkler Association

Richard R. Brown, Brown Sprinkler Corporation, KY [IM]

Rep. National Fire Sprinkler Association

Stephen A. Clark, Jr., Allianz Risk Consultants, GA [I]

Copyright NFPA

Brandon W. Frakes, GE Insurance Solutions, NC [I]

Robert M. Gagnon, Gagnon Engineering, MD [SE]

Luke Hilton, Liberty Mutual Property, NC [I]
Rep. Property Casualty Insurers Association of America

Gerald Kelliher, Westinghouse Savannah River Co., SC [U]

Kevin J. Kelly, National Fire Sprinkler Association, NY [M]

Marshall A. Klein, Marshall A. Klein & Associates, Incorporated, MD [SE]

Alan R. Laguna, Merit Sprinkler Company, Incorporated, LA [IM]

John Lake, Marion County Fire Rescue, FL [E]

George E. Laverick, Underwriters Laboratories Incorporated, IL [RT]

James M. Maddry, James M. Maddry, P.E., GA [SE]

Kevin D. Maughan, Tyco Fire & Building Products, RI [M]

David S. Mowrer, HSB Professional Loss Control, TN [I]

Robert A. Panero, Pacific Gas and Electric Company, CA [U]
Rep. Edison Electric Institute

Darrin A. Parsons, Road Sprinkler Fitters Local Union 669, MD [L]
Rep. United Association of Journeymen & Apprentices of the Plumbing & Pipe Fitting Industry of the US & Canada

Sam (Sat) Salwan, Environmental Systems Design, Incorporated, IL [SE]

James R. Schifiliti, Fire Safety Consultants, Incorporated, IL [IM]
Rep. Illinois Fire Prevention Association

James W. Simms, The RJA Group, Incorporated, CA [SE]

Alternates

Mark A. Bowman, GE Insurance Solutions, OH [I]
(Alt. to Brandon W. Frakes)

James K. Clancy, The RJA Group, Incorporated, CA [SE]
(Alt. to James W. Simms)

Copyright NFPA

David M. Hammerman, Marshall A. Klein and Associates, Incorporated, MD [SE]
(Alt. to Marshall A. Klein)

Charles F. Hill, Ryan Fire Protection, Incorporated, IN [M]
(Alt. to Kevin J. Kelly)

Peter T. Schwab, Wayne Automatic Fire Sprinklers, Incorporated, FL [IM]
(Alt. to Richard R. Brown)

Blake M. Shugarman, Underwriters Laboratories Incorporated, IL [RT]
(Alt. to George E. Laverick)

Lawrence Thibodeau, Hampshire Fire Protection Company Incorporated, NH [IM]
(Alt. to Phillip A. Brown)

Christian Dubay, NFPA Staff Liaison

This list represents the membership at the time the Committee was balloted on the final text of this edition. Since that time, changes in the membership may have occurred. A key to classifications is found at the back of the document .

NOTE: Membership on a committee shall not in and of itself constitute an endorsement of the Association or any document developed by the committee on which the member serves.

Committee Scope: This Committee shall have the primary responsibility for documents on private piping systems supplying water for fire protection and for hydrants, hose houses, and valves. The Committee is also responsible for documents on fire flow testing and marking of hydrants.

Technical Committee on Residential Sprinkler Systems

Daniel Madrzykowski, *Chair*

U.S. National Institute of Standards & Technology, MD [RT]

Christian Dubay, *Nonvoting Secretary*
National Fire Protection Association, MA

George W. Baker, Mashpee Fire & Rescue Department, MA [E]
Rep. International Association of Fire Chiefs

Kerry M. Bell, Underwriters Laboratories Incorporated, IL [RT]

Fred Benn, Advanced Automatic Sprinkler, Incorporated, CA [IM]

Jonathan C. Bittenbender, REHAU Incorporated, VA [M]

Frederick C. Bradley, FCB Engineering, GA [SE]

Lawrence Brown, National Association of Home Builders, DC [U]

Phillip A. Brown, American Fire Sprinkler Association, Incorporated, TX [IM]

Edward K. Budnick, Hughes Associates, Incorporated, MD [SE]

Thomas G. Deegan, The Viking Group, Incorporated, MI [M]
Rep. National Fire Sprinkler Association

Kenneth E. Isman, National Fire Sprinkler Association, NY [M]

Gary L. Johnson, Noveon, Incorporated, VA [M]
Rep. Committee for Firesafe Dwellings

David Killey, Fire Busters Incorporated, Canada [IM]
Rep. Canadian Automatic Sprinkler Association

Alan G. Larson, Uponor Wirsbo Company Incorporated, MN [M]

M. L. “Larry” Maruskin, U.S. Department of Homeland Security, MD [C]

Ronald G. Nickson, National Multi Housing Council, DC [U]

Eric Packard, Local 669 JATC Education Fund, MD [L]
Rep. United Association of Journeymen & Apprentices of the Plumbing & Pipe Fitting
Industry of the US & Canada

Maurice M. Pilette, Mechanical Designs Limited., MA [SE]

Chester W. Schirmer, Schirmer Engineering Corporation, NC [I]

Harry Shaw, Fail Safe Safety Systems Incorporated, MD [M]

George W. Stanley, Wiginton Fire Systems, FL [IM]
Rep. National Fire Sprinkler Association

Randolph W. Tucker, The RJA Group, Incorporated, TX [SE]

Ed Van Walraven, Aspen Fire Protection District, CO [E]

Terry L. Victor, Tyco/SimplexGrinnell, MD [M]

Hong-Zeng (Bert) Yu, FM Global, MA [I]

Alternates

David W. Ash, Noveon, Inc., OH [M]
(Alt. to Gary L. Johnson)

James K. Clancy, The RJA Group, Incorporated, CA [SE]
(Alt. to Randolph W. Tucker)

Mark E. Fessenden, Tyco Fire & Building Products, RI [M]
(Alt. to Terry L. Victor)

David B. Fuller, FM Global, MA [I]
(Alt. to Hong-Zeng (Bert) Yu)

Franz P. Haase, Uponor Wirsbo Company Inc., NH [M]
(Alt. to Alan G. Larson)

George E. Laverick, Underwriters Laboratories Inc., IL [RT]
(Alt. to Kerry M. Bell)

Thomas L. Multer, Reliable Automatic Sprinkler Company, SC [M]
(Alt. to Thomas G. Deegan)

Ron Murray, Plumbers and Steamfitters Local 290 (UA), OR [L]
(Alt. to Eric Packard)

Steven R. Rians, Standard Automatic Fire Enterprises, Incorporated, TX [IM]
(Voting Alt. to AFSA (IM) Rep.)

Peter T. Schwab, Wayne Automatic Fire Sprinklers, Incorporated, FL [IM]
(Alt. to George W. Stanley)

David W. Stroup, U.S. National Institute of Standards & Technology, MD [RT]
(Alt. to Daniel Madrzykowski)

Ronald N. Webb, S.A. Comunale Company, Incorporated, OH [M]
(Alt. to Kenneth E. Isman)

Joseph E. Wiehagen, National Association of Home Builders, MD [U]
(Alt. to Lawrence Brown)

James V. C. Yates, West Windsor Emergency Services, NJ [E]
(Alt. to George W. Baker)

Nonvoting

Rohit Khanna, U.S. Consumer Product Safety Commission, MD [C]

Christian Dubay, NFPA Staff Liaison

This list represents the membership at the time the Committee was balloted on the final text of this edition. Since that time, changes in the membership may have occurred. A key to classifications is found at the back of the document .

NOTE: Membership on a committee shall not in and of itself constitute an endorsement of the Association or any document developed by the committee on which the member serves.

Committee Scope: This Committee shall have primary responsibility for documents on the design and installation of automatic sprinkler systems in dwellings and residential occupancies up to and including four stories in height, including the character and adequacy of water supplies, and the selection of sprinklers, piping, valves, and all materials and accessories.

Technical Committee on Sprinkler System Discharge Criteria

Edward K. Budnick, Chair

Hughes Associates, Incorporated, MD [SE]

Christian Dubay, Nonvoting Secretary

National Fire Protection Association, MA

Charles O. Bauroth, Liberty Mutual Property, MA [I]
Rep. Property Casualty Insurers Association of America

Kerry M. Bell, Underwriters Laboratories Incorporated, IL [RT]

Michael H. Blumenthal, Rubber Manufacturers Association, DC [M]

James C. Bollier, Sprinkler Fitters UA Local 483, CA [L]
Rep. United Association of Journeymen & Apprentices of the Plumbing & Pipe Fitting Industry of the US & Canada

Thomas G. Deegan, The Viking Group, Incorporated, MI [M]

Russell P. Fleming, National Fire Sprinkler Association, NY [M]

James G. Gallup, The RJA Group, Incorporated, AZ [SE]

James E. Golinveaux, Tyco Fire & Building Products, RI [M]

Alfred J. Hogan, Reedy Creek Improvement District, FL [E]
Rep. New England Association of Fire Marshals

Roland J. Huggins, American Fire Sprinkler Association, Incorporated, TX [IM]
Rep. American Fire Sprinkler Association

Sultan M. Javeri, SC Engineering, France [IM]

Copyright NFPA

Larry Keeping, Vipond Fire Protection, Canada [IM]
Rep. Canadian Automatic Sprinkler Association

Andrew Kim, National Research Council of Canada, Canada [RT]

William E. Koffel, Koffel Associates, Incorporated, MD [SE]

Chris LaFleur, General Motors Corporation, MI [U]

Azarang (Ozzie) Mirkhah, Las Vegas Fire and Rescue, NV [E]

Thomas L. Multer, Reliable Automatic Sprinkler Company, SC [M]
Rep. National Fire Sprinkler Association

Richard Pehrson, Futrell Fire Consult and Design, Incorporated, MN [E]
Rep. International Fire Marshals Association

Chester W. Schirmer, Schirmer Engineering Corporation, NC [I]

Michael D. Sides, GE Insurance Solutions, FL [I]

Peter A. Smith, International Paper Company, TN [U]

David W. Stroup, U.S. National Institute of Standards & Technology, MD [RT]

Willie R. Templin, American Automatic Sprinkler, Incorporated, TX [IM]
Rep. American Fire Sprinkler Association

Jack W. Thacker, Allan Automatic Sprinkler Corp. of Southern California, CA [IM]
Rep. National Fire Sprinkler Association

William J. Tomes, TVA Fire and Life Safety, Incorporated, GA [U]
Rep. The Home Depot

Alternates

Carl P. Anderson, Tacoma Fire Department, WA [E]
(Alt. to Azarang (Ozzie) Mirkhah)

Weston C. Baker, Jr., FM Global, MA [I]
(Voting Alt. to FM Rep.)

Gordon Bates, Minneapolis Fire Department, MN [E]
(Alt. to Richard Pehrson)

Richard Battista, Fire Protection Industries, Inc., NJ [M]

Copyright NFPA

(Alt. to Russell P. Fleming)

Mark A. Bowman, GE Insurance Solutions, OH [I]

(Alt. to Michael D. Sides)

Thomas C. Brown, The RJA Group, Incorporated, MD [SE]

(Alt. to James G. Gallup)

John August Denhardt, Strickland Fire Protection, Incorporated, MD [IM]

(Alt. to Willie R. Templin)

Pravinray D. Gandhi, Underwriters Laboratories Incorporated, IL [RT]

(Alt. to Kerry M. Bell)

Donald Hopkins, Jr., Hughes Associates, Incorporated, MD [SE]

(Alt. to Edward K. Budnick)

Stephen R. Ide, Victaulic Company of America, PA [M]

(Alt. to Thomas L. Multer)

Daniel Madrzykowski, U.S. National Institute of Standards & Technology, MD [RT]

(Alt. to David W. Stroup)

Jack A. Medovich, East Coast Fire Protection, Incorporated, MD [IM]

(Alt. to Roland J. Huggins)

Matthew Osburn, Canadian Automatic Sprinkler Association, Canada [IM]

(Alt. to Larry Keeping)

Garner A. Palenske, Schirmer Engineering Corporation, CA [I]

(Alt. to Chester W. Schirmer)

Raymond P. Schmid, Koffel Associates, Incorporated, MD [SE]

(Alt. to William E. Koffel)

George W. Stanley, Wiginton Fire Systems, FL [IM]

(Alt. to Jack W. Thacker)

Peter W. Thomas, Tyco Fire & Building Products, RI [M]

(Alt. to James E. Golinveaux)

William P. Thomas, Jr., TVA Fire and Life Safety, Incorporated, IL [U]

(Alt. to William J. Tomes)

Martin H. Workman, The Viking Corporation, MI [M]

(Alt. to Thomas G. Deegan)

Copyright NFPA

Nonvoting

Barry M. Lee, Tyco International, Australia [M]

Christian Dubay, NFPA Staff Liaison

This list represents the membership at the time the Committee was balloted on the final text of this edition. Since that time, changes in the membership may have occurred. A key to classifications is found at the back of the document .

NOTE: Membership on a committee shall not in and of itself constitute an endorsement of the Association or any document developed by the committee on which the member serves.

Committee Scope: This Committee shall have primary responsibility for those portions of NFPA 13 that pertain to the classification of various fire hazards and the determination of associated discharge criteria for sprinkler systems employing automatic and open sprinklers.

Technical Committee on Sprinkler System Installation Criteria

Kenneth W. Linder, *Chair*
GE Insurance Solutions, CT [I]

Christian Dubay, *Nonvoting Secretary*
National Fire Protection Association, MA

Michael A. Amar, Gage-Babcock & Associates, Incorporated, CA [SE]

Weston C. Baker, Jr., FM Global, MA [I]

Edward K. Budnick, Hughes Associates, Incorporated, MD [SE]

Robert G. Caputo, Consolidated Fireprotection, Incorporated, CA [IM]
Rep. American Fire Sprinkler Association

Jean C. Carter, Jr., Louisiana Office of State Fire Marshal, LA [E]

Del Dornbos, The Viking Corporation, MI [M]
Rep. National Fire Sprinkler Association

Robert E. Duke, Fire Control Incorporated, IL [IM]

Randall Eberly, U.S. Coast Guard, DC [E]

David L. Foster, Insurance Services Office, Incorporated, NJ [I]

Ralph Gerdes, Ralph Gerdes Consultants, LLC, IN [SE]
Rep. American Institute of Architects

Copyright NFPA

Luke Hilton, Liberty Mutual Property, NC [I]

Kenneth E. Isman, National Fire Sprinkler Association, NY [M]

Larry Keeping, Vipond Fire Protection, Canada [IM]
Rep. Canadian Automatic Sprinkler Association

Michael D. Kirn, Code Consultants, Incorporated, MO [SE]

George E. Laverick, Underwriters Laboratories Incorporated., IL [RT]

Ausmus S. Marburger, Fire Protection Industries, Incorporated, PA [IM]
Rep. National Fire Sprinkler Association

Rodney A. McPhee, Canadian Wood Council, Canada [U]

Peter J. McWilliams, Eastman Kodak Company, NY [U]

Michael F. Meehan, Virginia Sprinkler Company, Incorporated, VA [IM]
Rep. American Fire Sprinkler Association

David S. Mowrer, HSB Professional Loss Control, TN [I]

Joe W. Noble, Clark County Fire Department, NV [E]
Rep. International Fire Marshals Association

Eric Packard, Local 669 JATC Education Fund, MD [L]
Rep. United Association of Journeymen & Apprentices of the Plumbing & Pipe Fitting
Industry of the US & Canada

Chester W. Schirmer, Schirmer Engineering Corporation, NC [I]

Craig R. Studer, The RJA Group, Incorporated, CA [SE]

Lynn K. Underwood, Axis US Property, IL [I]

Terry L. Victor, Tyco/SimplexGrinnell, MD [M]

Alternates

Hamid R. Bahadori, Hughes Associates, Incorporated, FL [SE]
(Alt. to Edward K. Budnick)

Kerry M. Bell, Underwriters Laboratories Incorporated, IL [RT]
(Alt. to George E. Laverick)

Phillip A. Brown, American Fire Sprinkler Association, Incorporated, TX [IM]
(Alt. to Robert G. Caputo)

Todd A. Dillon, GE Insurance Solutions, OH [I]
(Alt. to Kenneth W. Linder)

James E. Golinveaux, Tyco Fire & Building Products, RI [M]
(Alt. to Terry L. Victor)

Stephen R. Ide, Victaulic Company of America, PA [M]
(Alt. to Del Dornbos)

Elwin G. Joyce, II, Eastern Kentucky University, KY [U]
(Voting Alt. to NFPA/IFPS Rep.)

Richard S. Malek, Eastman Kodak Company, NY [U]
(Alt. to Peter J. McWilliams)

Thomas H. Miller, Varley-Campbell & Associates, Incorporated, IL [E]
(Voting Alt. to NFPA/FSS Rep.)

Richard Oliver, Oliver Sprinkler Company, Incorporated, PA [IM]
(Alt. to Ausmus S. Marburger)

Matthew Osburn, Canadian Automatic Sprinkler Association, Canada [IM]
(Alt. to Larry Keeping)

Michael A. Rothmier, UA Joint Apprenticeship Committee, CO [L]
(Alt. to Eric Packard)

Steven J. Scandaliato, Scandaliato Design Group, Incorporated, CO [IM]
(Alt. to Michael F. Meehan)

LeJay Slocum, Schirmer Engineering Corporation, MD [I]
(Alt. to Chester W. Schirmer)

William B. Smith, Code Consultants, Incorporated, MO [SE]
(Alt. to Michael D. Kirn)

Glenn E. Thompson, Liberty Mutual Property, CA [I]
(Alt. to Luke Hilton)

Robert Vincent, Shambaugh & Son, L.P., IN [M]
(Alt. to Kenneth E. Isman)

Corey C. Weldon, The RJA Group, Incorporated, TX [SE]

Copyright NFPA

(Alt. to Craig R. Studer)

Nonvoting

Barry M. Lee, Tyco International, Australia [M]

Christian Dubay, NFPA Staff Liaison

This list represents the membership at the time the Committee was balloted on the final text of this edition. Since that time, changes in the membership may have occurred. A key to classifications is found at the back of the document.

NOTE: Membership on a committee shall not in and of itself constitute an endorsement of the Association or any document developed by the committee on which the member serves.

Committee Scope: This Committee shall have the primary responsibility for those portions of NFPA 13 that pertain to the criteria for the use and installation of sprinkler systems components (with the exception of those components used for supporting of piping), position of sprinklers, types of systems, plans and calculations, water supplies, and acceptance testing.

NFPA 13 Standard for the Installation of Sprinkler Systems 2007 Edition

IMPORTANT NOTE: This NFPA document is made available for use subject to important notices and legal disclaimers. These notices and disclaimers appear in all publications containing this document and may be found under the heading “Important Notices and Disclaimers Concerning NFPA Documents.” They can also be obtained on request from NFPA or viewed at www.nfpa.org/disclaimers.

NOTICE: An asterisk (*) following the number or letter designating a paragraph indicates that explanatory material on the paragraph can be found in Annex A.

Changes other than editorial are indicated by a vertical rule beside the paragraph, table, or figure in which the change occurred. These rules are included as an aid to the user in identifying changes from the previous edition. Where one or more complete paragraphs have been deleted, the deletion is indicated by a bullet (•) between the paragraphs that remain.

A reference in brackets [] following a section or paragraph indicates material that has been extracted from another NFPA document. As an aid to the user, the complete title and edition of the source documents for extracts in mandatory sections of the document are given in Chapter 2 and those for extracts in informational sections are given in Annex E. Editorial changes to extracted material consist of revising references to an appropriate division in this document or the inclusion of the document number with the division number when the reference is to the original document. Requests for interpretations or revisions of extracted text shall be sent to the technical committee responsible for the source document.

Information on referenced publications can be found in Chapter 2 and Annex E.

Copyright NFPA

Chapter 1 Administration

1.1* Scope.

This standard shall provide the minimum requirements for the design and installation of automatic fire sprinkler systems and exposure protection sprinkler systems covered within this standard.

1.2* Purpose.

1.2.1 The purpose of this standard shall be to provide a reasonable degree of protection for life and property from fire through standardization of design, installation, and testing requirements for sprinkler systems, including private fire service mains, based on sound engineering principles, test data, and field experience.

1.2.2 Sprinkler systems and private fire service mains are specialized fire protection systems and shall require knowledgeable and experienced design and installation.

1.3 Application.

1.3.1 This standard shall apply to the following:

- (1) Character and adequacy of water supplies
- (2) Selection of sprinklers
- (3) Fittings
- (4) Piping
- (5) Valves
- (6) All materials and accessories, including the installation of private fire service mains

1.3.2 This standard shall also apply to “combined service mains” used to carry water for both fire service and other uses as well as to mains for fire service use only.

1.4 Retroactivity Clause.

The provisions of this standard reflect a consensus of what is necessary to provide an acceptable degree of protection from the hazards addressed in this standard at the time the standard was issued. Unless otherwise specified, the provisions of this standard shall not apply to facilities, equipment, structures, or installations that existed or were approved for construction or installation prior to the effective date of this standard. Where specified, the provisions of this standard shall be retroactive. In those cases where the authority having jurisdiction determines that the existing situation presents an unacceptable degree of risk, the authority having jurisdiction shall be permitted to apply retroactively any portions of this standard deemed appropriate.

1.5 Equivalency.

Copyright NFPA

Nothing in this standard is intended to prevent the use of systems, methods, or devices of equivalent or superior quality, strength, fire resistance, effectiveness, durability, and safety over those prescribed by this standard. Technical documentation shall be submitted to the authority having jurisdiction to demonstrate equivalency. The system, method, or device shall be approved for the intended purpose by the authority having jurisdiction.

1.6 New Technology.

1.6.1 Nothing in this standard shall be intended to restrict new technologies or alternate arrangements, provided the level of safety prescribed by this standard is not lowered.

1.6.2 Materials or devices not specifically designated by this standard shall be utilized in complete accord with all conditions, requirements, and limitations of their listings.

1.7 Units and Symbols.

1.7.1 Units.

1.7.1.1 Metric units of measurement in this standard are in accordance with the modernized metric system known as the International System of Units (SI).

1.7.1.2 Two units (liter and bar), outside of but recognized by SI, are commonly used in international fire protection.

1.7.1.3 These units are listed in Table 1.7.1.3 with conversion factors.

Table 1.7.1.3 SI Units and Conversion Factors

Name of Unit	Unit Symbol	Conversion Factor
liter	L	1 gal = 3.785 L
millimeter per minute	mm/min	1 gpm/ft ² = 40.746 mm/min = 40.746 (L/min)/m ²
cubic decimeter	dm ³	1 gal = 3.785 dm ³
pascal	Pa	1 psi = 6894.757 Pa
bar	bar	1 psi = 0.0689 bar
bar	bar	1 bar = 10 ⁵ Pa

Note: For additional conversions and information, see ASTM SI 10, *Standard for Use of the International System of Units (SI): The Modern Metric System*.

1.7.1.4 If a value for measurement as given in this standard is followed by an equivalent value in other units, the first stated is to be regarded as the requirement.

1.7.2 Symbols. The standard abbreviations in Table 1.7.2 shall be used on the hydraulic calculation form discussed in Chapter 22.

Table 1.7.2 Hydraulic Symbols

1.7.2 Symbols. The standard abbreviations in Table 1.7.2 shall be used on the hydraulic calculation form discussed in Chapter 22.

Table 1.7.2 Hydraulic Symbols

Symbol or Abbreviation	Item
p	Pressure in psi
gpm	U.S. gallons per minute
q	Flow increment in gpm to be added at a specific location
Q	Summation of flow in gpm at a specific location
P_t	Total pressure in psi at a point in a pipe
P_f	Pressure loss due to friction between points indicated in location column
P_e	Pressure due to elevation difference between indicated points. This can be a plus value or a minus value. If minus, the (-) shall be used; if plus, no sign need be indicated.
P_v	Velocity pressure in psi at a point in a pipe
P_n	Normal pressure in psi at a point in a pipe
E	90-degree ell
EE	45-degree ell
Lt.E	Long-turn elbow
Cr	Cross
T	Tee-flow turned 90 degrees
GV	Gate valve
BV	Butterfly (wafer) check valve
Del V	Deluge valve
ALV	Alarm valve
DPV	Dry pipe valve
CV	Swing check valve
WCV	Butterfly (wafer) check valve
St	Strainer
psi	Pounds per square inch
v	Velocity of water in pipe in feet per second

Chapter 2 Referenced Publications

2.1 General.

The documents or portions thereof listed in this chapter are referenced within this standard and shall be considered part of the requirements of this document.

2.2 NFPA Publications.

Copyright NFPA

National Fire Protection Association, 1 Batterymarch Park, Quincy, MA 02169-7471.

NFPA 11, *Standard for Low-, Medium-, and High-Expansion Foam*, 2005 edition. [Chapter 12] 12.11.1, [Chapter 18] 18.6.

NFPA 14, *Standard for the Installation of Standpipe and Hose Systems*, 2007 edition. [Chapter 8] 8.17.5.1.2, [Chapter 11] 11.1.5.6(1), 11.1.5.6(2), 11.1.5.6(3), [Chapter 12] 12.8.5(1), 12.8.5(2), 12.8.5(3).

NFPA 15, *Standard for Water Spray Fixed Systems for Fire Protection*, 2007 edition. [Chapter 21] 21.24.2.7, 21.33.1(2)(a).

NFPA 20, *Standard for the Installation of Stationary Pumps for Fire Protection*, 2007 edition. [Chapter 23] 23.2.2, [Chapter 25] 25.8.3.2.

NFPA 22, *Standard for Water Tanks for Private Fire Protection*, 2003 edition. [Chapter 8] 8.16.1.4.2.6, [Chapter 23] 23.2.3.1.1, 23.2.4.

NFPA 25, *Standard for the Inspection, Testing, and Maintenance of Water-Based Fire Protection System*, 2002 edition. [Chapter 24] 24.4(2), 24.6.1, [Chapter 25] 25.9.2, [Chapter 26] 26.1.

NFPA 30, *Flammable and Combustible Liquids Code*, 2003 edition. [Chapter 21] 21.2.1.

NFPA 30B, *Code for the Manufacture and Storage of Aerosol Products*, 2007 edition. [Chapter 21] 21.3.1.

NFPA 33, *Standard for Spray Application Using Flammable or Combustible Materials*, 2007 Edition. [Chapter 21] 21.4.1.2.

NFPA 40, *Standard for the Storage and Handling of Cellulose Nitrate Film*, 2007 edition. [Chapter 21] 21.7.2.2.2, 21.7.2.4.1, 21.7.2.4.2.

NFPA 42, *Code for the Storage of Pyroxylin Plastic*, 2002 edition. [Chapter 21] 21.8.2.1.

NFPA 51, *Standard for the Design and Installation of Oxygen–Fuel Gas Systems for Welding, Cutting, and Allied Processes*, 2002 edition. [Chapter 21] 21.10.1.1, 21.10.2.1.

NFPA 51A, *Standard for Acetylene Cylinder Charging Plants*, 2006 edition. [Chapter 21] 21.11.1.1.

NFPA 51B, *Standard for Fire Prevention During Welding, Cutting, and Other Hot Work*, 2003 edition. [Chapter 6] 6.5.2.2.2, 6.5.2.2.3.

NFPA 59, *Utility LP-Gas Plant Code*, 2004 edition. [Chapter 21] 21.13.1.1.

NFPA 59A, *Standard for the Production, Storage, and Handling of Liquefied Natural Gas (LNG)*, 2006 edition. [Chapter 21] 21.14.1.

NFPA 70, *National Electrical Code*®, 2005 edition. [Chapter 6] 6.9.4.2.

NFPA 72, *National Fire Alarm Code*®, 2007 edition. [Chapter 6] 6.9.4.1, [Chapter 7] 7.9.2.8.1.2, [Chapter 21] 21.24.2.8.2, 21.24.2.8.2.1.

NFPA 86, *Standard for Ovens and Furnaces*, 2007 edition. [Chapter 21] 21.18.2.

Copyright NFPA

NFPA 99, *Standard for Health Care Facilities*, 2005 edition. [Chapter 21] 21.19.1.1.

NFPA 101[®], *Life Safety Code*[®], 2006 edition. [Chapter 8] 8.15.8.1.2, [Chapter 21] 21.20.2.1.1, 21.20.17.2.1, 21.20.19.2.3, 21.20.20.2.2, 21.20.22.2.1, 21.20.23.2.1, 21.20.23.2.1(1), 21.20.23.2.1(3), 21.20.23.2.2(1), 21.20.23.2.2(2), 21.20.24.2.1, 21.20.24.2.1(1), 21.20.24.2.1(3), 21.20.24.2.2(1), 21.20.24.2.2(2), 21.20.27.1.1.

NFPA 170, *Standard for Fire Safety and Emergency Symbols*, 2006 edition. [Chapter 25] 25.2.7.5.

NFPA 214, *Standard on Water-Cooling Towers*, 2005 edition. [Chapter 21] 21.24.1.3.2, 21.24.1.4, 21.24.1.7.4, 21.24.2.8, 21.24.2.8.1.

NFPA 251, *Standard Methods of Tests of Fire Resistance of Building Construction and Materials*, 2006 edition. [Chapter 3] 3.3.18.

NFPA 255, *Standard Method of Test of Surface Burning Characteristics of Building Materials*, 2006 edition. [Chapter 3] 3.3.11, [Chapter 8] 8.15.1.2.10.

NFPA 259, *Standard Test Method for Potential Heat of Building Materials*, 2003 edition. [Chapter 3] 3.3.11.

NFPA 409, *Standard on Aircraft Hangars*, 2004 edition. [Chapter 21] 21.27.1, 21.27.2.

NFPA 432, *Code for the Storage of Organic Peroxide Formulations*, 2002 edition. [Chapter 21] 21.31.1.1.

NFPA 703, *Standard for Fire Retardant–Treated Wood and Fire-Retardant Coatings for Building Materials*, 2006 edition. [Chapter 8] 8.15.1.2.11, 8.15.7.2, 8.15.7.3, [Chapter 11] 11.2.3.1.4(4)(f), [Chapter 12] 12.9.2(6).

NFPA 780, *Standard for the Installation of Lightning Protection Systems*, 2004 edition. [Chapter 10] 10.6.8.

NFPA 1963, *Standard for Fire Hose Connections*, 2003 edition. [Chapter 6] 6.8.1, 6.8.1.1.

NFPA 5000[®], *Building Construction and Safety Code*[®], 2006 edition. [Chapter 21] 21.30.2.1.2.

2.3 Other Publications.

2.3.1 ASCE Publications.

American Society of Civil Engineers, 1801 Alexander Bell Drive, Reston, VA 20191-4400.

ASCE 7-05, *Minimum Design Loads for Buildings and Other Structures*, 2005. [Chapter 3] 3.11.6.

2.3.2 ASME Publications.

American Society of Mechanical Engineers, Three Park Avenue, New York, NY 10016-5990.

ASME BPVC-IX, *BPVC Section IX — Welding and Brazing Qualifications*, 2004. [Chapter

Copyright NFPA

6] 6.5.2.5.2.

ASME A17.1, *Safety Code for Elevators and Escalators*, 2000. [Chapter 8] 8.15.5.5.

ASME B1.20.1, *Pipe Threads, General Purpose (Inch)*, 2001. [Chapter 6] 6.5.1.1.

ASME B16.1, *Cast Iron Pipe Flanges and Flanged Fittings, Classes 25, 125, and 250*, 1998. [Chapter 6] Table 6.4.1, [Chapter 10] Table 10.2.1(a).

ASME B16.3, *Malleable Iron Threaded Fittings, Classes 150 and 300*, 1998. [Chapter 6] Table 6.4.1, [Chapter 10] Table 10.2.1(a).

ASME B16.4, *Cast Iron Threaded Fittings, Classes 125 and 250*, 1998. [Chapter 6] Table 6.4.1, [Chapter 10] Table 10.2.1(a).

ASME B16.5, *Pipe Flanges and Flanged Fittings*, 1996. [Chapter 6] Table 6.4.1, [Chapter 10] Table 10.2.1(a).

ASME B16.9, *Factory-Made Wrought Steel Buttwelding Fittings*, 2001. [Chapter 6] Table 6.4.1, [Chapter 10] Table 10.2.1(a).

ASME B16.11, *Forged Steel Fittings, Socket-Welding and Threaded*, 1996. [Chapter 6] Table 6.4.1, [Chapter 10] Table 10.2.1(a).

ASME B16.18, *Cast Copper Alloy Solder Joint Pressure Fittings*, 1994. [Chapter 6] Table 6.4.1, [Chapter 10] Table 10.2.1(a).

ASME B16.22, *Wrought Copper and Copper Alloy Solder Joint Pressure Fittings*, 1995. [Chapter 6] Table 6.4.1, [Chapter 10] Table 10.2.1(a).

ASME B16.25, *Buttwelding Ends*, 1997. [Chapter 6] Table 6.4.1, [Chapter 10] Table 10.2.1(a).

ANSI/ASME B31.1, *Code for Power Piping*, 2001. [Chapter 21] 21.32.2.1.3(1).

ANSI/ASME B36.10M, *Welded and Seamless Wrought Steel Pipe*, 2000. [Chapter 6] Table 6.3.1.1.

2.3.3 ASTM Publications.

American Society for Testing and Materials, 100 Barr Harbor Drive, P.O. Box C700, West Conshohocken, PA 19428-2959.

ANSI/ASTM A 53, *Standard Specification for Pipe, Steel, Black and Hot-Dipped, Zinc-Coated, Welded and Seamless*, 2001. [Chapter 6] Table 6.3.1.1.

ASTM A 135, *Standard Specification for Electric-Resistance-Welded Steel Pipe*, 2001. [Chapter 6] Table 6.3.1.1.

ASTM A 153A/153M, *Standard Specification for Zinc Coating (Hot Dip) on Iron and Steel Hardware*, 2004. [Chapter 21] 21.24.2.10.1.

ASTM A 234, *Standard Specification for Piping Fittings of Wrought-Carbon Steel and Alloy Steel for Moderate and High Temperature Service*, 2001. [Chapter 6] Table 6.4.1, [Chapter 10] Table 10.2.1(a).

Copyright NFPA

ASTM A 795, *Standard Specification for Black and Hot-Dipped Zinc-Coated (Galvanized) Welded and Seamless Steel Pipe for Fire Protection Use*, 2000. [Chapter 6] Table 6.3.1.1.

ASTM B 32, *Standard Specification for Solder Metal*, 2000. [Chapter 6] Table 6.3.1.1.

ASTM B 75, *Standard Specification for Seamless Copper Tube*, 1999. [Chapter 6] Table 6.3.1.1, [Chapter 10] Table 10.1.1.

ASTM B 88, *Standard Specification for Seamless Copper Water Tube*, 1999. [Chapter 6] Table 6.3.1.1, [Chapter 10] Table 10.1.1.

ASTM B 251, *Standard Specification for General Requirements for Wrought Seamless Copper and Copper-Alloy Tube*, 1997. [Chapter 6] Table 6.3.1.1, [Chapter 10] Table 10.1.1.

ASTM B 446, *Standard Specification for Nickel-Chromium-Molybdenum-Columbium Alloy (UNSN 06625) and Nickel-Chromium-Molybdenum-Silicon Alloy (UNSN 06219) Rod and Bar*, 2000. [Chapter 6] Table 6.3.1.1.

ASTM B 813, *Standard Specification for Liquid and Paste Fluxes for Soldering Applications of Copper and Copper-Alloy Tube*, 2000. [Chapter 6] Table 6.3.1.1.

ASTM B 828, *Standard Practice for Making Capillary Joints by Soldering of Copper and Copper Alloy Tube and Fittings*, 2000. [Chapter 6] 6.5.4.1.

ASTM C 635, *Standard Specification for the Manufacture, Performance, and Testing of Metal Suspension Systems for Acoustical Tile and Lay-In Panel Ceilings*, 2004. [Chapter 9] 9.2.1.3.3.2.

ASTM C 636, *Standard Practice for Installation of Metal Ceiling Suspension Systems for Acoustical Tile and Lay-In Panels*, 2004. [Chapter 9] 9.2.1.3.3.2.

ASTM E 84, *Standard Test Method for Surface Burning Characteristics of Building Materials*, 2004. [Chapter 3] 3.3.11.

ASTM E 119, *Standard Test Methods for Fire Tests of Building Construction and Materials*, 2000. [Chapter 3] 3.10.1, 3.10.2, 3.10.9, [Chapter 25] 25.1.3(1), 25.1.3(2).

ASTM E 136, *Standard Test Method for Behavior of Materials in a Vertical Tube Furnace at 750°C*, 1999. [Chapter 3] 3.3.12.

ASTM F 437, *Standard Specification for Threaded Chlorinated Poly (Vinyl Chloride) (CPVC) Plastic Pipe Fittings, Schedule 80*, 1999. [Chapter 6] Table 6.4.3, [Chapter 10] Table 10.2.1(b).

ASTM F 438, *Standard Specification for Socket-Type Chlorinated Poly (Vinyl Chloride) (CPVC) Plastic Pipe Fittings, Schedule 40*, 2001. [Chapter 6] Table 6.4.3, [Chapter 10] Table 10.2.1(b).

ASTM F 439, *Standard Specification for Socket-Type Chlorinated Poly (Vinyl Chloride) (CPVC) Plastic Pipe Fittings, Schedule 80*, 2001. [Chapter 6] Table 6.4.3, [Chapter 10] Table 10.2.1(b).

ASTM F 442, *Standard Specification for Chlorinated Poly (Vinyl Chloride) (CPVC) Plastic*

Pipe (SDR-PR), 1999. [Chapter 6] Table 6.3.6.1.

ASTM F 1121, *Standard Specification for International Shore Connections for Marine Fire Applications*, 1998. [Chapter 25] 25.2.7.8.

ASTM SI 10, *Standard for Use of the International System of Units (SI): The Modern Metric System*, 1997. [Chapter 1] 1.7.1.3.

2.3.4 AWS Publications.

American Welding Society, 550 N.W. LeJeune Road, Miami, FL 33126.

AWS A5.8, *Specification for Filler Metals for Brazing and Braze Welding*, 1992. [Chapter 6] Table 6.3.1.1.

AWS B2.1, *Specification for Welding Procedure and Performance Qualification*, 2000. [Chapter 6] 6.5.2.5.2.

2.3.5 AWWA Publications.

American Water Works Association, 6666 West Quincy Avenue, Denver, CO 80235.

AWWA C104, *Cement Mortar Lining for Ductile Iron Pipe and Fittings for Water*, 1995. [Chapter 10] Table 10.1.1.

AWWA C105, *Polyethylene Encasement for Ductile Iron Pipe Systems*, 1999. [Chapter 10] Table 10.1.1.

AWWA C110, *Ductile Iron and Gray Iron Fittings, 3-in. Through 48-in. (76 mm Through 1219 mm), for Water and Other Liquids*, 1998. [Chapter 10] Table 10.1.1.

AWWA C111, *Rubber Gasket Joints for Ductile Iron Pressure Pipe and Fittings*, 2000. [Chapter 10] Table 10.1.1.

AWWA C115, *Flanged Ductile Iron Pipe with Ductile Iron or Gray Iron Threaded Flanges*, 1999. [Chapter 10] Table 10.1.1.

AWWA C 116, *Protective Fusion-Bonded Epoxy Coatings Internal and External Surface Ductile-Iron/Gray-Iron Fittings*, 2003. [Chapter 10] Table 10.1.1.

AWWA C150, *Thickness Design of Ductile Iron Pipe*, 1996. [Chapter 10] Table 10.1.1.

AWWA C151, *Ductile Iron Pipe, Centrifugally Cast for Water*, 1996. [Chapter 10] Table 10.1.1.

AWWA C153, *Ductile-Iron Compact Fittings for Water Service*, 2000. [Chapter 10] Table 10.1.1.

AWWA C200, *Steel Water Pipe 6 in. (150 mm) and Larger*, 1997. [Chapter 10] Table 10.1.1.

AWWA C203, *Coal-Tar Protective Coatings and Linings for Steel Water Pipelines Enamel and Tape — Hot Applied*, 1997. [Chapter 10] Table 10.1.1.

AWWA C205, *Cement-Mortar Protective Lining and Coating for Steel Water Pipe 4 in.*

(100 mm) and Larger — Shop Applied, 2000. [Chapter 10] Table 10.1.1.

AWWA C206, *Field Welding of Steel Water Pipe*, 1997. [Chapter 10] Table 10.1.1.

AWWA C207, *Steel Pipe Flanges for Waterworks Service — Sizes 4 in. Through 144 in. (100 mm Through 3,600 mm)*, 1994. [Chapter 10] Table 10.1.1.

AWWA C208, *Dimensions for Fabricated Steel Water Pipe Fittings*, 1996. [Chapter 10] Table 10.1.1.

AWWA C300, *Reinforced Concrete Pressure Pipe, Steel-Cylinder Type, for Water and Other Liquids*, 1997. [Chapter 10] Table 10.1.1.

AWWA C301, *Prestressed Concrete Pressure Pipe, Steel-Cylinder Type, for Water and Other Liquids*, 1999. [Chapter 10] Table 10.1.1.

AWWA C302, *Reinforced Concrete Pressure Pipe, Non-Cylinder Type, for Water and Other Liquids*, 1995. [Chapter 10] Table 10.1.1.

AWWA C303, *Reinforced Concrete Pressure Pipe, Steel-Cylinder Type, Pretensioned, for Water and Other Liquids*, 1995. [Chapter 10] Table 10.1.1.

AWWA C400, *Standard for Asbestos-Cement Distribution Pipe, 4 in. Through 16 in. (100 mm Through 400 mm), for Water and Other Liquids*, 1998. [Chapter 10] Table 10.1.1.

AWWA C401, *Standard Practice for the Selection of Asbestos-Cement Water Pipe, 4 in. Through 16 in. (100 mm Through 400 mm)*, 1998. [Chapter 10] Table 10.1.1.

AWWA C600, *Standard for the Installation of Ductile Iron Water Mains and Their Appurtenances*, 1999. [Chapter 10] Table 10.1.1, 10.10.2.3.

AWWA C602, *Cement-Mortar Lining of Water Pipe Lines 4 in. (100 mm) and Larger — in Place*, 2000. [Chapter 10] Table 10.1.1, 10.10.2.3.

AWWA C603, *Standard for the Installation of Asbestos-Cement Water Pipe*, 1996. [Chapter 10] Table 10.1.1, 10.10.2.3.

AWWA C900, *Polyvinyl Chloride (PVC) Pressure Pipe, 4 in. Through 12 in. (100 mm Through 300 mm), for Water and Other Liquids*, 1997. [Chapter 10] Table 10.1.1, 10.10.2.3.

AWWA C906, *Polyethylene (PE) Pressure Pipe and Fittings, 4 in. (100 mm) Th. 63 in (1,575 mm), for Water Distribution and Transportation*, 1999. [Chapter 10] Table 10.1.1.

AWWA M11, *A Guide for Steel Pipe Design and Installation*, 3rd edition, 1989. [Chapter 10] Table 10.1.1.

2.3.6 IEEE Publications.

Institute of Electrical and Electronics Engineers, Three Park Avenue, 17th Floor, New York, NY 10016–5997.

IEEE 45, *Recommended Practice for Electric Installations on Shipboard*, 1998. [Chapter 25] 25.4.12.8.

Copyright NFPA

2.3.7 UL Publications.

Underwriters Laboratories Inc., 333 Pfingsten Road, Northbrook, IL 60062-2096.

UL 300, *Standard for Safety Fire Testing of Fire Extinguishing Systems for Protection of Restaurant Cooking Areas*, 1998. [Chapter 7] 7.10.3.4.1.

2.3.8 U.S. Government Publications.

U.S. Government Printing Office, Washington, DC 20402.

Title 46, CFR, Parts 54.15-10 Safety and Relief Valves, [Chapter 25] 25.7.2.3.2, 56.20 Valves, [Chapter 25] 25.2.6.2, 56.20-5(a) Markings, [Chapter 25] 25.2.6.3, 56.50-95 Overboard Discharges and Shore Connections, [Chapter 25] 25.4.11.2, 25.4.13, 56.60 Materials, [Chapter 25] 25.2.6.2, 25.4.11.2, and 58.01-40 Machinery, Angle of Inclination. [Chapter 25] 25.6.4.

Title 46, CFR, Subchapter F, “Marine Engineering.” [Chapter 25] 25.7.2.1(6), 25.7.4.5.

Title 46, CFR, Subchapter J, “Electrical Engineering.” [Chapter 25] 25.4.12.7.

2.3.9 Other Publications.

Merriam-Webster’s Collegiate Dictionary, 11th edition, Merriam-Webster, Inc., Springfield, MA, 2003. [Chapter 3] 3.1.

2.4 References for Extracts in Mandatory Sections.

NFPA 24, *Standard for the Installation of Private Fire Service Mains and Their Appurtenances*, 2007 edition.

NFPA 33, *Standard for Spray Application Using Flammable or Combustible Materials*, 2007 edition.

NFPA 37, *Standard for the Installation and Use of Stationary Combustion Engines and Gas Turbines*, 2006 edition.

NFPA 40, *Standard for the Storage and Handling of Cellulose Nitrate Film*, 2007 edition.

NFPA 42, *Code for the Storage of Pyroxylin Plastic*, 2002 edition.

NFPA 45, *Standard on Fire Protection for Laboratories Using Chemicals*, 2004 edition.

NFPA 51, *Standard for the Design and Installation of Oxygen–Fuel Gas Systems for Welding, Cutting, and Allied Processes*, 2002 edition.

NFPA 51A, *Standard for Acetylene Cylinder Charging Plants*, 2006 edition.

NFPA 55, *Standard for the Storage, Use, and Handling of Compressed Gases and Cryogenic Fluids in Portable and Stationary Containers, Cylinders, and Tanks*, 2005 edition.

NFPA 59, *Utility LP-Gas Plant Code*, 2004 edition.

NFPA 59A, *Standard for the Production, Storage, and Handling of Liquefied Natural Gas*

Copyright NFPA

(LNG), 2006 edition.

NFPA 75, *Standard for the Protection of Information Technology Equipment*, 2003 edition.

NFPA 82, *Standard on Incinerators and Waste and Linen Handling Systems and Equipment*, 2004 edition.

NFPA 86, *Standard for Ovens and Furnaces*, 2007 edition.

NFPA 99, *Standard for Health Care Facilities*, 2005 edition.

NFPA 101®, *Life Safety Code®*, 2006 edition.

NFPA 130, *Standard for Fixed Guideway Transit and Passenger Rail Systems*, 2007 edition.

NFPA 140, *Standard on Motion Picture and Television Production Studio Soundstages and Approved Production Facilities*, 2004 edition.

NFPA 150, *Standard on Fire and Life Safety in Animal Housing Facilities*, 2007 edition.

NFPA 214, *Standard on Water-Cooling Towers*, 2005 edition.

NFPA 220, *Standard on Types of Building Construction*, 2006 edition.

NFPA 307, *Standard for the Construction and Fire Protection of Marine Terminals, Piers, and Wharves*, 2006 edition.

NFPA 318, *Standard for the Protection of Semiconductor Fabrication Facilities*, 2006 edition.

NFPA 415, *Standard on Airport Terminal Buildings, Fueling Ramp Drainage, and Loading Walkways*, 2002 edition.

NFPA 423, *Standard for Construction and Protection of Aircraft Engine Test Facilities*, 2004 edition.

NFPA 430, *Code for the Storage of Liquid and Solid Oxidizers*, 2004 edition.

NFPA 432, *Code for the Storage of Organic Peroxide Formulations*, 2002 edition.

NFPA 804, *Standard for Fire Protection for Advanced Light Water Reactor Electric Generating Plants*, 2006 edition.

NFPA 805, *Performance-Based Standard for Fire Protection for Light Water Reactor Electric Generating Plants*, 2006 edition.

NFPA 850, *Recommended Practice for Fire Protection for Electric Generating Plants and High Voltage Direct Current Converter Stations*, 2005 edition.

NFPA 851, *Recommended Practice for Fire Protection for Hydroelectric Generating Plants*, 2005 edition.

NFPA 909, *Code for the Protection of Cultural Resource Properties — Museums, Libraries, and Places of Worship*, 2005 edition.

Copyright NFPA

Chapter 3 Definitions

3.1 General.

The definitions contained in this chapter shall apply to the terms used in this standard. Where terms are not defined in this chapter or within another chapter, they shall be defined using their ordinarily accepted meanings within the context in which they are used.

Merriam-Webster's Collegiate Dictionary, 11th edition, shall be the source for the ordinarily accepted meaning.

3.2 NFPA Official Definitions.

3.2.1* Approved. Acceptable to the authority having jurisdiction.

3.2.2* Authority Having Jurisdiction (AHJ). An organization, office, or individual responsible for enforcing the requirements of a code or standard, or for approving equipment, materials, an installation, or a procedure.

3.2.3* Listed. Equipment, materials, or services included in a list published by an organization that is acceptable to the authority having jurisdiction and concerned with evaluation of products or services, that maintains periodic inspection of production of listed equipment or materials or periodic evaluation of services, and whose listing states that either the equipment, material, or service meets appropriate designated standards or has been tested and found suitable for a specified purpose.

3.2.4 Shall. Indicates a mandatory requirement.

3.2.5 Should. Indicates a recommendation or that which is advised but not required.

3.2.6 Standard. A document, the main text of which contains only mandatory provisions using the word "shall" to indicate requirements and which is in a form generally suitable for mandatory reference by another standard or code or for adoption into law. Nonmandatory provisions shall be located in an appendix or annex, footnote, or fine-print note and are not to be considered a part of the requirements of a standard.

3.3 General Definitions.

3.3.1 Automatic Sprinkler. A fire suppression or control device that operates automatically when its heat-activated element is heated to its thermal rating or above, allowing water to discharge over a specified area.

3.3.2* Bathroom. Within a dwelling unit, any room or compartment containing a lavatory dedicated to personal hygiene, or a water closet, or bathing capability such as a shower or tub, or any combination of facilities thereof.

3.3.3 Ceiling Height. The distance between the floor and the underside of the ceiling above (or roof deck) within the area.

3.3.4 Ceiling Types.

3.3.4.1 Flat Ceiling. A continuous ceiling in a single plane.

3.3.4.2 Horizontal Ceiling. A ceiling with a slope not exceeding 2 in 12.

3.3.4.3 Sloped Ceiling. A ceiling with a slope exceeding 2 in 12.

3.3.4.4 Smooth Ceiling. A continuous ceiling free from significant irregularities, lumps, or indentations.

3.3.5 Compartment. A space completely enclosed by walls and a ceiling. The compartment enclosure is permitted to have openings in walls to an adjoining space if the openings have a minimum lintel depth of 8 in. (203 mm) from the ceiling and the openings do not exceed 8 ft (2.44 m) in width. A single opening of 36 in. (914 mm) or less in width without a lintel is permitted when there are no other openings to adjoining spaces.

3.3.6 Drop-Out Ceiling. A suspended ceiling system, which is installed below the sprinklers, with listed translucent or opaque panels that are heat sensitive and fall from their setting when exposed to heat.

3.3.7 Dwelling Unit. One or more rooms arranged for the use of one or more individuals living together, as in a single housekeeping unit normally having cooking, living, sanitary, and sleeping facilities. For purposes of this standard, dwelling unit includes hotel rooms, dormitory rooms, apartments, condominiums, sleeping rooms in nursing homes, and similar living units.

3.3.8 Fire Control. Limiting the size of a fire by distribution of water so as to decrease the heat release rate and pre-wet adjacent combustibles, while controlling ceiling gas temperatures to avoid structural damage.

3.3.9 Fire Suppression. Sharply reducing the heat release rate of a fire and preventing its regrowth by means of direct and sufficient application of water through the fire plume to the burning fuel surface.

3.3.10 Hydraulically Designed System. A calculated sprinkler system in which pipe sizes are selected on a pressure loss basis to provide a prescribed water density, in gallons per minute per square foot (mm/min), or a prescribed minimum discharge pressure or flow per sprinkler, distributed with a reasonable degree of uniformity over a specified area.

3.3.11 Limited-Combustible Material. Refers to a building construction material not complying with the definition of noncombustible material that, in the form in which it is used, has a potential heat value not exceeding 3500 Btu/lb (8141 kJ/kg), where tested in accordance with NFPA 259, *Standard Test Method for Potential Heat of Building Materials*, and includes either (1) materials having a structural base of noncombustible material, with a surfacing not exceeding a thickness of $\frac{1}{8}$ in. (3.2 mm) that has a flame spread index not greater than 50 or (2) materials, in the form and thickness used having neither a flame spread index greater than 25 nor evidence of continued progressive combustion, and of such composition that surfaces that would be exposed by cutting through the material on any plane would have neither a flame spread index greater than 25 nor evidence of continued progressive combustion when tested in accordance with NFPA 255 or ASTM E 84. [220, 2006]

3.3.12 Noncombustible Material. A substance that will not ignite and burn when subjected to a fire. Materials that are reported as passing ASTM E 136, *Standard Test Method for Behavior of Materials in a Vertical Tube Furnace at 750°C*, shall be considered noncombustible materials.

3.3.13 Pipe Schedule System. A sprinkler system in which the pipe sizing is selected from a schedule that is determined by the occupancy classification and in which a given number of sprinklers are allowed to be supplied from specific sizes of pipe.

3.3.14 Shop-Welded. As used in this standard, *shop* in the term *shop-welded* means either (1) a sprinkler contractor's or fabricator's premise or (2) an area specifically designed or authorized for welding, such as a detached outside location, maintenance shop, or other area (either temporary or permanent) of noncombustible or fire-resistive construction free of combustible and flammable contents and suitably segregated from adjacent areas.

3.3.15 Small Room. A room of light hazard occupancy classification having unobstructed construction and floor areas not exceeding 800 ft² (74.3 m²) that are enclosed by walls and a ceiling. Openings in walls not exceeding 8 ft (2.44 m) in width to adjoining spaces are permitted if the minimum lintel depth is 8 in. (203 mm) from the ceiling. A single opening of 36 in. (914 mm) or less in width without a lintel is permitted when there are no other openings to adjoining spaces.

3.3.16* Sprinkler System. For fire protection purposes, an integrated system of underground and overhead piping designed in accordance with fire protection engineering standards. The installation includes at least one automatic water supply which supplies one or more systems. The portion of the sprinkler system above ground is a network of specially sized or hydraulically designed piping installed in a building, structure, or area, generally overhead, and to which sprinklers are attached in a systematic pattern. Each system has a control valve located in the system riser or its supply piping. Each sprinkler system includes a device for actuating an alarm when the system is in operation. The system is usually activated by heat from a fire and discharges water over the fire area.

3.3.17 System Working Pressure. The maximum anticipated static (nonflowing) or flowing pressure applied to sprinkler system components exclusive of surge pressures and exclusive of pressure from the fire department connection.

3.3.18 Thermal Barrier. A material that will limit the average temperature rise of the unexposed surface to not more than 250°F (121°C) after 15 minutes of fire exposure, which complies with the standard time-temperature curve of NFPA 251, *Standard Methods of Tests of Fire Resistance of Building Construction and Materials*.

3.4 Sprinkler System Type Definitions.

3.4.1 Antifreeze Sprinkler System. A wet pipe sprinkler system employing automatic sprinklers that are attached to a piping system that contains an antifreeze solution and that are connected to a water supply. The antifreeze solution is discharged, followed by water, immediately upon operation of sprinklers opened by heat from a fire.

3.4.2 Circulating Closed-Loop Sprinkler System. A wet pipe sprinkler system having

non-fire protection connections to automatic sprinkler systems in a closed-loop piping arrangement for the purpose of utilizing sprinkler piping to conduct water for heating or cooling, where water is not removed or used from the system but only circulated through the piping system.

3.4.3 Combined Dry Pipe-Preaction Sprinkler System. A sprinkler system employing automatic sprinklers attached to a piping system containing air under pressure with a supplemental detection system installed in the same areas as the sprinklers. Operation of the detection system actuates tripping devices that open dry pipe valves simultaneously and without loss of air pressure in the system. Operation of the detection system also opens listed air exhaust valves at the end of the feed main, which usually precedes the opening of sprinklers. The detection system also serves as an automatic fire alarm system.

3.4.4 Deluge Sprinkler System. A sprinkler system employing open sprinklers that are attached to a piping system that is connected to a water supply through a valve that is opened by the operation of a detection system installed in the same areas as the sprinklers. When this valve opens, water flows into the piping system and discharges from all sprinklers attached thereto.

3.4.5 Dry Pipe Sprinkler System. A sprinkler system employing automatic sprinklers that are attached to a piping system containing air or nitrogen under pressure, the release of which (as from the opening of a sprinkler) permits the water pressure to open a valve known as a dry pipe valve, and the water then flows into the piping system and out the opened sprinklers.

3.4.6* Gridded Sprinkler System. A sprinkler system in which parallel cross mains are connected by multiple branch lines. An operating sprinkler will receive water from both ends of its branch line while other branch lines help transfer water between cross mains.

3.4.7* Looped Sprinkler System. A sprinkler system in which multiple cross mains are tied together so as to provide more than one path for water to flow to an operating sprinkler and branch lines are not tied together.

3.4.8 Multi-Cycle System. A type of sprinkler system capable of repeated on-off flow cycles in response to heat.

3.4.9* Preaction Sprinkler System. A sprinkler system employing automatic sprinklers that are attached to a piping system that contains air that might or might not be under pressure, with a supplemental detection system installed in the same areas as the sprinklers.

3.4.10 Wet Pipe Sprinkler System. A sprinkler system employing automatic sprinklers attached to a piping system containing water and connected to a water supply so that water discharges immediately from sprinklers opened by heat from a fire.

3.5* System Component Definitions.

3.5.1 Branch Lines. The pipes supplying sprinklers, either directly or through sprigs, drops, return bends, or arm-overs.

3.5.2 Cross Mains. The pipes supplying the branch lines, either directly or through risers.

3.5.3 Feed Mains. The pipes supplying cross mains, either directly or through risers.

3.5.4 Flexible Listed Pipe Coupling. A listed coupling or fitting that allows axial displacement, rotation, and at least 1 degree of angular movement of the pipe without inducing harm on the pipe. For pipe diameters of 8 in. (203.2 mm) and larger, the angular movement shall be permitted to be less than 1 degree but not less than 0.5 degree.

3.5.5 Risers. The vertical supply pipes in a sprinkler system.

3.5.6 Sprig. A pipe that rises vertically and supplies a single sprinkler.

3.5.7 Supervisory Device. A device arranged to supervise the operative condition of automatic sprinkler systems.

3.5.8 System Riser. The aboveground horizontal or vertical pipe between the water supply and the mains (cross or feed) that contains a control valve (either directly or within its supply pipe) and a waterflow alarm device.

3.5.9 Arm-over. A horizontal pipe that extends from the branch line to a single sprinkler or a sprinkler above and below a ceiling.

3.5.10 Waterflow Alarm Device. An attachment to the sprinkler system that detects a predetermined water flow and is connected to a fire alarm system to initiate an alarm condition or is used to mechanically or electrically initiate a fire pump or local audible or visual alarm.

3.6 Sprinkler Definitions.

3.6.1* Sprinkler Characteristics, General. The following are characteristics of a sprinkler that define its ability to control or extinguish a fire. (a) Thermal sensitivity. A measure of the rapidity with which the thermal element operates as installed in a specific sprinkler or sprinkler assembly. One measure of thermal sensitivity is the response time index (RTI) as measured under standardized test conditions. (1) Sprinklers defined as fast response have a thermal element with an RTI of 50 (meters-seconds)^{1/2} or less. (2) Sprinklers defined as standard response have a thermal element with an RTI of 80 (meters-seconds)^{1/2} or more. (b) Temperature rating. (c) Orifice size (*see Chapter 6*). (d) Installation orientation (*see 3.6.3*). (e) Water distribution characteristics (i.e., application rate, wall wetting). (f) Special service conditions (*see 3.6.4*).

3.6.2 Sprinkler Types. The following sprinklers are defined according to design and performance characteristics.

3.6.2.1* Early Suppression Fast-Response (ESFR) Sprinkler. A type of fast-response sprinkler that meets the criteria of 3.6.1(a)(1) and is listed for its capability to provide fire suppression of specific high-challenge fire hazards.

3.6.2.2 Extended Coverage Sprinkler. A type of spray sprinkler with maximum coverage areas as specified in Sections 8.8 and 8.9 of this standard.

3.6.2.3 Large Drop Sprinkler. A type of specific application control mode sprinkler that is capable of producing characteristic large water droplets and that is listed for its capability to

provide fire control of specific high-challenge fire hazards.

3.6.2.4 Nozzles. A device for use in applications requiring special water discharge patterns, directional spray, or other unusual discharge characteristics.

3.6.2.5 Old-Style/Conventional Sprinkler. A sprinkler that directs from 40 percent to 60 percent of the total water initially in a downward direction and that is designed to be installed with the deflector either upright or pendent.

3.6.2.6 Open Sprinkler. A sprinkler that does not have actuators or heat-responsive elements.

3.6.2.7* Quick-Response Early Suppression (QRES) Sprinkler. A type of quick-response sprinkler that meets the criteria of 3.6.1(a)(1) and is listed for its capability to provide fire suppression of specific fire hazards.

3.6.2.8 Quick-Response Extended Coverage Sprinkler. A type of quick-response sprinkler that meets the criteria of 3.6.1(a)(1) and complies with the extended protection areas defined in Chapter 8.

3.6.2.9* Quick-Response (QR) Sprinkler. A type of spray sprinkler that meets the fast response criteria of 3.6.1(a)(1) and is listed as a quick-response sprinkler for its intended use.

3.6.2.10 Residential Sprinkler. A type of fast-response sprinkler that meets the criteria of 3.6.1(a)(1) that has been specifically investigated for its ability to enhance survivability in the room of fire origin and is listed for use in the protection of dwelling units.

3.6.2.11 Special Sprinkler. A sprinkler that has been tested and listed as prescribed in 8.4.8.

3.6.2.12 Specific Application Control Mode Sprinkler (for Storage Use). A type of spray sprinkler listed at a minimum operating pressure with a specific number of operating sprinklers for a given protection scheme.

3.6.2.13 Spray Sprinkler. A type of sprinkler listed for its capability to provide fire control for a wide range of fire hazards.

3.6.2.14 Standard Spray Sprinkler. A spray sprinkler with maximum coverage areas as specified in Sections 8.6 and 8.7 of this standard.

3.6.3 Installation Orientation. The following sprinklers are defined according to orientation.

3.6.3.1 Concealed Sprinkler. A recessed sprinkler with cover plates.

3.6.3.2 Flush Sprinkler. A sprinkler in which all or part of the body, including the shank thread, is mounted above the lower plane of the ceiling.

3.6.3.3 Pendent Sprinkler. A sprinkler designed to be installed in such a way that the water stream is directed downward against the deflector.

3.6.3.4 Recessed Sprinkler. A sprinkler in which all or part of the body, other than the shank thread, is mounted within a recessed housing.

3.6.3.5 Sidewall Sprinkler. A sprinkler having special deflectors that are designed to

discharge most of the water away from the nearby wall in a pattern resembling one-quarter of a sphere, with a small portion of the discharge directed at the wall behind the sprinkler.

3.6.3.6 Upright Sprinkler. A sprinkler designed to be installed in such a way that the water spray is directed upwards against the deflector.

3.6.4 Special Service Conditions. The following sprinklers are defined according to special application or environment.

3.6.4.1 Corrosion-Resistant Sprinkler. A sprinkler fabricated with corrosion-resistant material, or with special coatings or platings, to be used in an atmosphere that would normally corrode sprinklers.

3.6.4.2* Dry Sprinkler. A sprinkler secured in an extension nipple that has a seal at the inlet end to prevent water from entering the nipple until the sprinkler operates.

3.6.4.3 Institutional Sprinkler. A sprinkler specially designed for resistance to load-bearing purposes and with components not readily converted for use as weapons.

3.6.4.4 Intermediate Level Sprinkler/Rack Storage Sprinkler. A sprinkler equipped with integral shields to protect its operating elements from the discharge of sprinklers installed at higher elevations.

3.6.4.5 Ornamental/Decorative Sprinkler. A sprinkler that has been painted or plated by the manufacturer.

3.6.4.6 Pilot Line Detector. A standard spray sprinkler or thermostatic fixed-temperature release device used as a detector to pneumatically or hydraulically release the main valve, controlling the flow of water into a fire protection system.

3.7 Construction Definitions.

3.7.1* Obstructed Construction. Panel construction and other construction where beams, trusses, or other members impede heat flow or water distribution in a manner that materially affects the ability of sprinklers to control or suppress a fire.

3.7.2* Unobstructed Construction. Construction where beams, trusses, or other members do not impede heat flow or water distribution in a manner that materially affects the ability of sprinklers to control or suppress a fire. Unobstructed construction has horizontal structural members that are not solid, where the openings are at least 70 percent of the cross-section area and the depth of the member does not exceed the least dimension of the openings, or all construction types where the spacing of structural members exceeds 7½ ft (2.3 m) on center.

3.8 Private Water Supply Piping Definitions.

3.8.1 General Definitions from NFPA 24.

3.8.1.1 Appurtenance. An accessory or attachment that enables the private fire service main to perform its intended function. [24, 2007]

3.8.1.2 Corrosion Resistant Piping. Piping that has the property of being able to withstand deterioration of its surface or its properties when exposed to its environment. [24, 2007]

3.8.1.3 Corrosion Retardant Material. A lining or coating material that when applied to piping or appurtenances has the property of reducing or slowing the deterioration of the object's surface or properties when exposed to its environment. [24, 2007]

3.8.1.4 Fire Department Connection. A connection through which the fire department can pump supplemental water into the sprinkler system, standpipe, or other system, furnishing water for fire extinguishment to supplement existing water supplies. [24, 2007]

3.8.1.5 Fire Pump. A pump supplying water at the flow and pressure required by water-based fire protection systems. [24, 2007]

3.8.1.6 Hose House. An enclosure located over or adjacent to a hydrant or other water supply designed to contain the necessary hose nozzles, hose wrenches, gaskets, and spanners to be used in fire fighting in conjunction with and to provide aid to the local fire department. [24, 2007]

3.8.1.7 Hydrant Butt. The hose connection outlet of a hydrant. [24, 2007]

3.8.1.8 Hydraulically Calculated Water Demand Flow Rate. The water flow rate for a system or hose stream that has been calculated using accepted engineering practices. [24, 2007]

3.8.1.9 Pressure.

3.8.1.9.1 Residual Pressure. The pressure that exists in the distribution system, measured at the residual hydrant at the time the flow readings are taken at the flow hydrants. [24, 2007]

3.8.1.9.2 Static Pressure. The pressure that exists at a given point under normal distribution system conditions measured at the residual hydrant with no hydrants flowing. [24, 2007]

3.8.1.10 Pressure Regulating Device. A device designed for the purpose of reducing, regulating, controlling, or restricting water pressure. Examples include pressure-reducing valves, pressure-control valves, and pressure-restricting devices. [24, 2007]

3.8.1.11* Private Fire Service Main. Private fire service main, as used in this standard, is that pipe and its appurtenances on private property (1) between a source of water and the base of the system riser for water-based fire protection systems, (2) between a source of water and inlets to foam-making systems, (3) between a source of water and the base elbow of private hydrants or monitor nozzles, and (4) used as fire pump suction and discharge piping, (5) beginning at the inlet side of the check valve on a gravity or pressure tank. [24, 2007]

3.8.1.12 Pumper Outlet. The hydrant outlet intended for use by fire departments for taking supply from the hydrant for pumpers. [24, 2007]

3.8.1.13 Rated Capacity. The flow available from a hydrant at the designated residual pressure (rated pressure) either measured or calculated. [24, 2007]

3.8.1.14 Test.

3.8.1.14.1 Flow Test. A test performed by the flow and measurement of water from one hydrant and the static and residual pressures from an adjacent hydrant for the purpose of determining the available water supply at that location. [24, 2007]

3.8.1.14.2 Flushing Test. A test of a piping system using high velocity flows to remove debris from the piping system prior to it being placed in service. [24, 2007]

3.8.1.14.3 Hydrostatic Test. A test of a closed piping system and its attached appurtenances consisting of subjecting the piping to an increased internal pressure for a specified period of duration to verify system integrity and leak rates. [24, 2007]

3.8.1.15 Valve.

3.8.1.15.1 Check Valve. A valve that allows flow in one direction only. [24, 2007]

3.8.1.15.2 Indicating Valve. A valve that has components that show if the valve is open or closed. Examples are outside screw and yoke (OS&Y) gate valves and underground gate valves with indicator posts. [24, 2007]

3.8.2 Hydrant Definitions from NFPA 24.

3.8.2.1 Hydrant. An exterior valved connection to a water supply system that provides hose connections. [24, 2007]

3.8.2.1.1 Dry Barrel Hydrant. This is the most common type of hydrant; it has a control valve below the frost line between the footpiece and the barrel. A drain is located at the bottom of the barrel above the control valve seat for proper drainage after operation. [24, 2007]

3.8.2.1.2 Flow Hydrant. The hydrant that is used for the flow and flow measurement of water during a flow test. [24, 2007]

3.8.2.1.3 Private Fire Hydrant. A valved connection on a water supply system having one or more outlets and that is used to supply hose and fire department pumpers with water on private property. Where connected to a public water system, the private hydrants are supplied by a private service main that begins at the point of service designated by the authority having jurisdiction, usually at a manually operated valve near the property line. [24, 2007]

3.8.2.1.4 Public Hydrant. A valved connection on a water supply system having one or more outlets and that is used to supply hose and fire department pumpers with water. [24, 2007]

3.8.2.1.5 Residual Hydrant. The hydrant that is used for measuring static and residual pressures during a flow test. [24, 2007]

3.8.2.1.6 Wet Barrel Hydrant. A type of hydrant that sometimes is used where there is no danger of freezing weather. Each outlet on a wet barrel hydrant is provided with a valved outlet threaded for fire hose. [24, 2007]

3.9 Storage Definitions.

3.9.1 General.

3.9.1.1* Available Height for Storage. The maximum height at which commodities can be stored above the floor and still maintain necessary clearance from structural members and the required clearance below sprinklers.

3.9.1.2 Cartoned. A method of storage consisting of corrugated cardboard or paperboard containers fully enclosing the commodity.

3.9.1.3 Clearance. The distance from the top of storage to the ceiling sprinkler deflectors.

3.9.1.4 Commodity. The combination of products, packing material, and container that determines commodity classification.

3.9.1.5* Compartmented. The rigid separation of the products in a container by dividers that form a stable unit under fire conditions.

3.9.1.6* Container (Shipping, Master, or Outer Container). A receptacle strong enough, by reason of material, design, and construction, to be shipped safely without further packaging.

3.9.1.7* Conventional Pallets. A material-handling aid designed to support a unit load with openings to provide access for material-handling devices. (*See Figure A.3.9.1.7.*)

3.9.1.8 Encapsulation. A method of packaging consisting of a plastic sheet completely enclosing the sides and top of a pallet load containing a combustible commodity or a combustible package or a group of combustible commodities or combustible packages. Combustible commodities individually wrapped in plastic sheeting and stored exposed in a pallet load also are to be considered encapsulated. Totally noncombustible commodities on wood pallets enclosed only by a plastic sheet as described are not covered under this definition. Banding (i.e., stretch-wrapping around the sides only of a pallet load) is not considered to be encapsulation. Where there are holes or voids in the plastic or waterproof cover on the top of the carton that exceed more than half of the area of the cover, the term *encapsulated* does not apply. The term *encapsulated* does not apply to plastic-enclosed products or packages inside a large, nonplastic, enclosed container.

3.9.1.9 Expanded (Foamed or Cellular) Plastics. Those plastics, the density of which is reduced by the presence of numerous small cavities (cells), interconnecting or not, dispersed throughout their mass.

3.9.1.10 Exposed Group A Plastic Commodities. Those plastics not in packaging or coverings that absorb water or otherwise appreciably retard the burning hazard of the commodity. (Paper wrapped or encapsulated, or both, should be considered exposed.)

3.9.1.11 Free-Flowing Plastic Materials. Those plastics that fall out of their containers during a fire, fill flue spaces, and create a smothering effect on the fire. Examples include powder, pellets, flakes, or random-packed small objects [e.g., razor blade dispensers, 1 oz to 2 oz (28 g to 57 g) bottles].

3.9.1.12 High-Challenge Fire Hazard. A fire hazard typical of that produced by fires in combustible high-piled storage.

3.9.1.13 High-Piled Storage. Solid-piled, palletized, rack storage, bin box, and shelf storage in excess of 12 ft (3.7 m) in height.

3.9.1.14* Miscellaneous Storage. Storage that does not exceed 12 ft (3.66 m) in height and is incidental to another occupancy use group. Such storage shall not constitute more than 10 percent of the building area or 4000 ft² (372 m²) of the sprinklered area, whichever is greater. Such storage shall not exceed 1000 ft² (93 m²) in one pile or area, and each such pile or area shall be separated from other storage areas by at least 25 ft (7.62 m).

3.9.1.15 Packaging. A commodity wrapping, cushioning, or container.

3.9.1.16 Plastic Pallet. A pallet having any portion of its construction consisting of a plastic material.

3.9.1.17* Reinforced Plastic Pallet. A plastic pallet incorporating a secondary reinforcing material (such as steel or fiberglass) within the pallet.

3.9.1.18 Roof Height. The distance between the floor and the underside of the roof deck within the storage area.

3.9.1.19 Slave Pallet. A special pallet captive to a material-handling system. (*See Figure A.3.9.1.7.*)

3.9.1.20 Storage Aids. Commodity storage devices, such as pallets, dunnage, separators, and skids.

3.9.1.21 Unit Load. A pallet load or module held together in some manner and normally transported by material-handling equipment.

3.9.1.22 Wood Pallet. A pallet constructed entirely of wood with metal fasteners.

3.9.2 Palletized, Solid Pile, Bin Box, and Shelf Storage.

3.9.2.1 Array.

3.9.2.1.1 Closed Array. A storage arrangement where air movement through the pile is restricted because of 6 in. (152 mm) or less vertical flues.

3.9.2.1.2* Open Array. A storage arrangement where air movement through the pile is enhanced because of vertical flues larger than 6 in. (152 mm).

3.9.2.2 Bin Box Storage. Storage in five-sided wood, metal, or cardboard boxes with open face on the aisles. Boxes are self-supporting or supported by a structure so designed that little or no horizontal or vertical space exists around boxes.

3.9.2.3 Palletized Storage. Storage of commodities on pallets or other storage aids that form horizontal spaces between tiers of storage.

3.9.2.4* Pile Stability, Stable Piles. Those arrays where collapse, spillage of content, or leaning of stacks across flue spaces is not likely to occur soon after initial fire development.

3.9.2.5* Pile Stability, Unstable Piles. Those arrays where collapse, spillage of contents, or leaning of stacks across flue spaces occurs soon after initial fire development.

3.9.2.6 Shelf Storage. Storage on structures up to and including 30 in. (762 mm) deep with shelves usually 2 ft (0.6 m) apart vertically and separated by approximately 30 in. (762 mm) aisles.

3.9.2.7 Solid Unit Load of a Nonexpanded Plastic (Either Cartoned or Exposed). A load that does not have voids (air) within the load and that burns only on the exterior of the load; water from sprinklers might reach most surfaces available to burn.

3.9.3 Rack Storage.

3.9.3.1* Aisle Width. The horizontal dimension between the face of the loads in racks under consideration. (See Figure A.3.9.3.1.)

3.9.3.2 Automotive Components on Portable Racks. Automotive components on portable racks are defined as the following: instrument panels, windshields, metal and plastic gasoline tanks, heater housings, door panels, interior trim, bumper facia, wiring harnesses, sheet metal, body components, engines, driveline components, steering mechanisms, auxiliary motors, and lighting — all with or without expanded plastic donnage. This definition does not include the storage of air bags, tires, and seats on portable racks.

3.9.3.3 Bulkhead. A vertical barrier across the rack.

3.9.3.4 Face Sprinklers. Standard sprinklers that are located in transverse flue spaces along the aisle or in the rack, are within 18 in. (0.46 m) of the aisle face of storage, and are used to oppose vertical development of fire on the external face of storage.

3.9.3.5 Horizontal Barrier. A solid barrier in the horizontal position covering the entire rack, including all flue spaces at certain height increments, to prevent vertical fire spread.

3.9.3.6* Longitudinal Flue Space. The space between rows of storage perpendicular to the direction of loading. (See Figure A.3.9.3.6.)

3.9.3.7* Rack. Any combination of vertical, horizontal, and diagonal members that supports stored materials. Shelving in some rack structures use shelves that can be solid, slatted, or open. Racks can be fixed, portable, or movable. Loading can be either manual — using lift trucks, stacker cranes, or hand placement — or automatic — using machine-controlled storage and retrieval systems.

3.9.3.7.1 Double-Row Racks. Racks less than or equal to 12 ft (3.7 m) in depth or single-row racks placed back to back having an aggregate depth up to 12 ft (3.7 m), with aisles having an aisle width of at least 3.5 ft (1.1 m) between loads on racks.

3.9.3.7.2 Movable Racks. Racks on fixed rails or guides. They can be moved back and forth only in a horizontal, two-dimensional plane. A moving aisle is created as abutting racks are either loaded or unloaded, then moved across the aisle to abut other racks.

3.9.3.7.3 Multiple-Row Racks. Racks greater than 12 ft (3.7 m) in depth or single- or double-row racks separated by aisles less than 3.5 ft (1.1 m) wide having an overall width greater than 12 ft (3.7 m).

3.9.3.7.4 Portable Racks. Racks that are not fixed in place. They can be arranged in any

number of configurations.

3.9.3.7.5 Single-Row Racks. Racks that have no longitudinal flue space and that have a depth up to 6 ft (1.8 m) with aisles having a width of at least 3.5 ft (1.1 m) between loads on racks.

3.9.3.8 Solid Shelving. Solid shelving is fixed in place, slatted, wire mesh or other type of shelves located within racks. The area of a solid shelf is defined by perimeter aisle or flue space on all four sides. Solid shelves having an area equal to or less than 20 ft² (1.9 m²) shall be defined as open racks. Shelves of wire mesh, slates, or other materials more than 50 percent open and where the flue spaces are maintained shall be defined as open racks.

3.9.3.9 Transverse Flue Space. The space between rows of storage parallel to the direction of loading. (See Figure A.3.9.3.6.)

3.9.4 Rubber Tire Storage Definitions.

3.9.4.1 Banded Tires. A storage method in which a number of tires are strapped together.

3.9.4.2 Horizontal Channel. Any uninterrupted space in excess of 5 ft (1.5 m) in length between horizontal layers of stored tires. Such channels can be formed by pallets, shelving, racks, or other storage arrangements.

3.9.4.3 Laced Tire Storage. Tires stored where the sides of the tires overlap, creating a woven or laced appearance. [See Figure A.3.9.4.9(g).]

3.9.4.4* Miscellaneous Tire Storage. The storage of rubber tires that is incidental to the main use of the building. Storage areas shall not exceed 2000 ft² (186 m²). On-tread storage piles, regardless of storage method, shall not exceed 25 ft (7.6 m) in the direction of the wheel holes. Acceptable storage arrangements include (a) on-floor, on-side storage up to 12 ft (3.7 m) high; (b) on-floor, on-tread storage up to 5 ft (1.5 m) high; (c) double-row or multirow fixed or portable rack storage on-side or on-tread up to 5 ft (1.5 m) high; (d) single row fixed or portable rack storage on-side or on-tread up to 12 ft (3.7 m) high; and (e) laced tires in racks up to 5 ft (1.5 m) in height.

3.9.4.5 On-Side Tire Storage. Tires stored horizontally or flat.

3.9.4.6 On-Tread Tire Storage. Tires stored vertically or on their treads.

3.9.4.7 Palletized Tire Storage. Storage on portable racks of various types utilizing a conventional pallet as a base.

3.9.4.8 Pyramid Tire Storage. On-floor storage in which tires are formed into a pyramid to provide pile stability.

3.9.4.9* Rubber Tire Rack Illustrations. See Figure A.3.9.4.9(a) through Figure A.3.9.4.9(g).

3.9.4.10 Rubber Tires. Pneumatic tires for passenger automobiles, aircraft, light and heavy trucks, trailers, farm equipment, construction equipment (off-the-road), and buses.

3.9.5 Roll Paper Definitions.

3.9.5.1 Array (Paper).

3.9.5.1.1 Closed Array (Paper). A vertical storage arrangement in which the distances between columns in both directions are short [not more than 2 in. (50 mm) in one direction and 1 in. (25 mm) in the other].

3.9.5.1.2 Open Array (Paper). A vertical storage arrangement in which the distance between columns in both directions is lengthy (all vertical arrays other than closed or standard).

3.9.5.1.3* Standard Array (Paper). A vertical storage arrangement in which the distance between columns in one direction is short [1 in. (25 mm) or less] and is in excess of 2 in. (50 mm) in the other direction.

3.9.5.2 Banded Roll Paper Storage. Rolls provided with a circumferential steel strap [$\frac{3}{8}$ in. (9.5 mm) or wider] at each end of the roll.

3.9.5.3 Column. A single vertical stack of rolls.

3.9.5.4 Core. The central tube around which paper is wound to form a roll.

3.9.5.5 Paper (General Term). The term for all kinds of felted sheets made from natural fibrous materials, usually vegetable but sometimes mineral or animal, and formed on a fine wire screen from water suspension.

3.9.5.6 Roll Paper Storage.

3.9.5.6.1 Horizontal Roll Paper Storage. Rolls stored with the cores in the horizontal plane (on-side storage).

3.9.5.6.2 Vertical Roll Paper Storage. Rolls stored with the cores in the vertical plane (on-end storage).

3.9.5.6.3* Wrapped Roll Paper Storage. Rolls provided with a complete heavy kraft covering around both sides and ends.

3.9.5.7* Roll Paper Storage Height. The maximum vertical distance above the floor at which roll paper is normally stored.

3.9.6 Baled Cotton Definitions.

3.9.6.1* Baled Cotton. A natural seed fiber wrapped and secured in industry-accepted materials, usually consisting of burlap, woven polypropylene, or sheet polyethylene, and secured with steel, synthetic or wire bands, or wire; also includes linters (lint removed from the cottonseed) and motes (residual materials from the ginning process). (*See Table A.3.9.6.1.*)

3.9.6.2* Tiered Storage. An arrangement in which bales are stored directly on the floor, two or more bales high.

•

3.10 Marine Definitions.

These definitions apply to Chapter 17 only.

3.10.1 A-Class Boundary. A boundary designed to resist the passage of smoke and flame for 1 hour when tested in accordance with ASTM E 119, *Standard Test Methods for Fire Tests of Building Construction and Materials*.

3.10.2 B-Class Boundary. A boundary designed to resist the passage of flame for ½ hour when tested in accordance with ASTM E 119, *Standard Test Methods for Fire Tests of Building Construction and Materials*.

3.10.3 Central Safety Station. A continuously manned control station from which all of the fire control equipment is monitored. If this station is not the bridge, direct communication with the bridge shall be provided by means other than the ship's service telephone.

3.10.4* Heat-Sensitive Material. A material whose melting point is below 1700°F (926.7°C).

3.10.5 Heel. The inclination of a ship to one side.

3.10.6 Heel Angle. The angle defined by the intersection of a vertical line through the center of a vessel and a line perpendicular to the surface of the water.

3.10.7 International Shore Connection. A universal connection to the vessel's fire main to which a shoreside fire-fighting water supply can be connected.

3.10.8* Marine System. A sprinkler system installed on a ship, boat, or other floating structure that takes its supply from the water on which the vessel floats.

3.10.9* Marine Thermal Barrier. An assembly that is constructed of noncombustible materials and made intact with the main structure of the vessel, such as shell, structural bulkheads, and decks. A marine thermal barrier shall meet the requirements of a B-Class boundary. In addition, a marine thermal barrier shall be insulated such that, if tested in accordance with ASTM E 119, *Standard Test Methods for Fire Tests of Building Construction and Materials*, for 15 minutes, the average temperature of the unexposed side does not rise more than 250°F (193°C) above the original temperature, nor does the temperature at any one point, including any joint, rise more than 405°F (225°C) above the original temperature.

3.10.10 Supervision. A visual and audible alarm signal given at the central safety station to indicate when the system is in operation or when a condition that would impair the satisfactory operation of the system exists. Supervisory alarms shall give a distinct indication for each individual system component that is monitored.

3.10.11 Survival Angle. The maximum angle to which a vessel is permitted to heel after the assumed damage required by stability regulations is imposed.

3.10.12 Type 1 Stair. A fully enclosed stair that serves all levels of a vessel in which persons can be employed.

3.10.13 Marine Water Supply. The supply portion of the sprinkler system from the water pressure tank or the sea suction of the designated sprinkler system pump up to and including

the valve that isolates the sprinkler system from these two water sources.

3.11 Hanging and Bracing Definitions.

3.11.1 Sway Brace. An assembly intended to be attached to the piping to resist horizontal earthquake loads.

3.11.2 Four-Way Brace. A sway brace intended to resist differential movement of the piping system in all horizontal directions.

3.11.3 Lateral Brace. A sway brace intended to resist differential movement perpendicular to the axis of the pipe.

3.11.4 Longitudinal Brace. A sway brace intended to resist differential movement parallel to the axis of the pipe.

3.11.5 F_{pw} . The horizontal force due to seismic load acting on a brace at working stress levels.

3.11.6 C_p . The seismic coefficient that combines ground motion and seismic response factors from ASCE 7-05.

3.11.7 S_s . The Maximum Considered Earthquake Ground Motion for 0.2 sec Spectral Response Acceleration (5% of Critical Damping), Site Class B for a specific site.

Chapter 4 General Requirements

4.1 Level of Protection.

A building, where protected by an automatic sprinkler system installation, shall be provided with sprinklers in all areas except where specific sections of this standard permit the omission of sprinklers.

4.2 Limited Area Systems.

4.2.1 When partial sprinkler systems are installed, the requirements of this standard shall be used insofar as they are applicable.

4.2.2 The authority having jurisdiction shall be consulted in each case.

4.3* Owner's Certificate.

The owner(s) of a building or structure where the fire sprinkler system is going to be installed or their authorized agent shall provide the sprinkler systems installer with the following information prior to the layout and detailing of the fire sprinkler system [*See Figure A.22.1(b)*]:

- (1) Intended use of the building including the materials within the building and the maximum height of any storage
- (2) A preliminary plan of the building or structure along with the design concepts

necessary to perform the layout and detail for the fire sprinkler system

- (3) Any special knowledge of the water supply, including known environmental conditions that might be responsible for corrosion, including microbiologically influenced corrosion (MIC)

4.4* Additives.

Additives or chemicals intended to stop leaks, such as sodium silicate or derivatives of sodium silicate, brine, or similar acting chemicals, shall not be used in sprinkler systems.

Chapter 5 Classification of Occupancies and Commodities

5.1* Classification of Occupancies.

5.1.1 Occupancy classifications for this standard shall relate to sprinkler design, installation, and water supply requirements only.

5.1.2 Occupancy classifications shall not be intended to be a general classification of occupancy hazards.

5.2* Light Hazard Occupancies.

Light hazard occupancies shall be defined as occupancies or portions of other occupancies where the quantity and/or combustibility of contents is low and fires with relatively low rates of heat release are expected.

5.3* Ordinary Hazard Occupancies.

5.3.1* Ordinary Hazard (Group 1). Ordinary hazard (Group 1) occupancies shall be defined as occupancies or portions of other occupancies where combustibility is low, quantity of combustibles is moderate, stockpiles of combustibles do not exceed 8 ft (2.4 m), and fires with moderate rates of heat release are expected. Dedicated and miscellaneous storage shall be protected in accordance with Chapter 12 and Chapter 13 as applicable.

5.3.2* Ordinary Hazard (Group 2). Ordinary hazard (Group 2) occupancies shall be defined as occupancies or portions of other occupancies where the quantity and combustibility of contents are moderate to high, where stockpiles of contents with moderate rates of heat release do not exceed 12 ft (3.66 m) and stockpiles of contents with high rates of heat release do not exceed 8 ft (2.4 m). Dedicated and miscellaneous storage shall be protected in accordance with Chapter 12 and Chapter 13 as applicable.

5.4 Extra Hazard Occupancies.

5.4.1* Extra Hazard (Group 1). Extra hazard (Group 1) occupancies shall be defined as occupancies or portions of other occupancies where the quantity and combustibility of contents are very high and dust, lint, or other materials are present, introducing the probability of rapidly developing fires with high rates of heat release but with little or no combustible or flammable liquids.

5.4.2* Extra Hazard (Group 2). Extra hazard (Group 2) occupancies shall be defined as occupancies or portions of other occupancies with moderate to substantial amounts of flammable or combustible liquids or occupancies where shielding of combustibles is extensive.

5.5* Special Occupancy Hazards.

5.6* Commodity Classification.

See Section C.2.

5.6.1 General.

5.6.1.1* Classification of Commodities.

5.6.1.1.1 Commodity classification and the corresponding protection requirements shall be determined based on the makeup of individual storage units (i.e., unit load, pallet load).

5.6.1.1.2 When specific test data of commodity classification by a nationally recognized testing agency are available, the data shall be permitted to be used in determining classification of commodities.

5.6.1.2 Mixed Commodities.

5.6.1.2.1 Protection requirements shall not be based on the overall commodity mix in a fire area.

5.6.1.2.2 Unless the requirements of 5.6.1.2.3 or 5.6.1.2.4 are met, mixed commodity storage shall be protected by the requirements for the highest classified commodity and storage arrangement.

5.6.1.2.3 The protection requirements for the lower commodity class shall be permitted to be utilized where all of the following are met:

- (1) Up to 10 pallet loads of a higher hazard commodity, as described in 5.6.3 and 5.6.4, shall be permitted to be present in an area not exceeding 40,000 ft² (3716 m²).
- (2) The higher hazard commodity shall be randomly dispersed with no adjacent loads in any direction (including diagonally).
- (3) Where the ceiling protection is based on Class I or Class II commodities, the allowable number of pallet loads for Class IV or Group A plastics shall be reduced to five.

5.6.1.2.4 Mixed Commodity Segregation. The protection requirements for the lower commodity class shall be permitted to be utilized in the area of lower commodity class, where the higher hazard material is confined to a designated area and the area is protected to the higher hazard in accordance with the requirements of this standard.

5.6.2 Pallet Types.

5.6.2.1 When loads are palletized, the use of wood or metal pallets shall be assumed in the classification of commodities.

Copyright NFPA

5.6.2.2 For Class I through Class IV, when unreinforced polypropylene or high-density polyethylene plastic pallets are used, the classification of the commodity unit shall be increased one class (e.g., Class III will become Class IV, and Class IV will become cartoned unexpanded Group A plastics). Unreinforced polypropylene or unreinforced high-density polyethylene plastic pallets shall be marked with a permanent symbol to indicate that the pallet is unreinforced.

5.6.2.3 For Class I through Class IV, when reinforced polypropylene or high-density polyethylene plastic pallets are used, the classification of the commodity unit shall be increased two classes except for Class IV commodity, which shall be increased to a cartoned unexpanded Group A plastic commodity (e.g., Class II will become Class IV, and Class III and Class IV will become a cartoned unexpanded Group A plastic commodity). Pallets shall be assumed to be reinforced if no permanent marking or manufacturer's certification of non-reinforcement is provided.

5.6.2.4 For Class I through Class IV when other than polypropylene or high-density polyethylene plastic pallets are used, the classification of the commodity unit shall be determined by specific testing conducted by a national testing laboratory or shall be increased two classes.

5.6.2.5 No increase in the commodity classification shall be required for Group A plastic commodities stored on plastic pallets.

5.6.2.6 For ceiling-only sprinkler protection, the requirements of 5.6.2.2 and 5.6.2.3 shall not apply where plastic pallets are used and where the sprinkler system uses spray sprinklers with a minimum K-factor of 16.8.

5.6.2.7 The requirements of 5.6.2.2 through 5.6.2.4 shall not apply to nonwood pallets that have demonstrated a fire hazard that is equal to or less than wood pallets and are listed as such.

5.6.3* Commodity Classes.

5.6.3.1* Class I. A Class I commodity shall be defined as a noncombustible product that meets one of the following criteria:

- (1) Placed directly on wood pallets
- (2) Placed in single-layer corrugated cartons, with or without single-thickness cardboard dividers, with or without pallets
- (3) Shrink-wrapped or paper-wrapped as a unit load with or without pallets

5.6.3.2* Class II. A Class II commodity shall be defined as a noncombustible product that is in slatted wooden crates, solid wood boxes, multiple-layered corrugated cartons, or equivalent combustible packaging material, with or without pallets.

5.6.3.3* Class III.

5.6.3.3.1 A Class III commodity shall be defined as a product fashioned from wood, paper, natural fibers, or Group C plastics with or without cartons, boxes, or crates and with or

without pallets.

5.6.3.3.2 A Class III commodity shall be permitted to contain a limited amount (5 percent by weight or volume or less) of Group A or Group B plastics.

5.6.3.4* Class IV.

5.6.3.4.1 A Class IV commodity shall be defined as a product, with or without pallets, that meets one of the following criteria:

- (1) Constructed partially or totally of Group B plastics
- (2) Consists of free-flowing Group A plastic materials
- (3) Contains within itself or its packaging an appreciable amount (5 percent to 15 percent by weight or 5 percent to 25 percent by volume) of Group A plastics

5.6.3.4.2 The remaining materials shall be permitted to be metal, wood, paper, natural or synthetic fibers, or Group B or Group C plastics.

5.6.4* Classification of Plastics, Elastomers, and Rubber. Plastics, elastomers, and rubber shall be classified as Group A, Group B, or Group C.

5.6.4.1* Group A. The following materials shall be classified as Group A:

- (1) ABS (acrylonitrile-butadiene-styrene copolymer)
- (2) Acetal (polyformaldehyde)
- (3) Acrylic (polymethyl methacrylate)
- (4) Butyl rubber
- (5) EPDM (ethylene-propylene rubber)
- (6) FRP (fiberglass-reinforced polyester)
- (7) Natural rubber (if expanded)
- (8) Nitrile-rubber (acrylonitrile-butadiene-rubber)
- (9) PET (thermoplastic polyester)
- (10) Polybutadiene
- (11) Polycarbonate
- (12) Polyester elastomer
- (13) Polyethylene
- (14) Polypropylene
- (15) Polystyrene
- (16) Polyurethane
- (17) PVC (polyvinyl chloride — highly plasticized, with plasticizer content greater than 20

percent) (rarely found)

(18) SAN (styrene acrylonitrile)

(19) SBR (styrene-butadiene rubber)

5.6.4.2 Group B. The following materials shall be classified as Group B:

(1) Cellulosics (cellulose acetate, cellulose acetate butyrate, ethyl cellulose)

(2) Chloroprene rubber

(3) Fluoroplastics (ECTFE — ethylene-chlorotrifluoro-ethylene copolymer; ETFE — ethylene-tetrafluoroethylene-copolymer; FEP — fluorinated ethylene-propylene copolymer)

(4) Natural rubber (not expanded)

(5) Nylon (nylon 6, nylon 6/6)

(6) Silicone rubber

5.6.4.3 Group C. The following materials shall be classified as Group C:

(1) Fluoroplastics (PCTFE — polychlorotrifluoroethylene; PTFE — polytetrafluoroethylene)

(2) Melamine (melamine formaldehyde)

(3) Phenolic

(4) PVC (polyvinyl chloride — flexible — PVCs with plasticizer content up to 20 percent)

(5) PVDC (polyvinylidene chloride)

(6) PVDF (polyvinylidene fluoride)

(7) PVF (polyvinyl fluoride)

(8) Urea (urea formaldehyde)

5.6.5* Classification of Rolled Paper Storage. For the purposes of this standard, the classifications of paper described in 5.6.5.1 through 5.6.5.4 shall apply and shall be used to determine the sprinkler system design criteria.

5.6.5.1 Heavyweight Class. Heavyweight class shall be defined so as to include paperboard and paper stock having a basis weight [weight per 1000 ft² (92.9 m²)] of 20 lb (9.1 kg).

5.6.5.2 Mediumweight Class. Mediumweight class shall be defined so as to include all the broad range of papers having a basis weight [weight per 1000 ft² (92.9 m²)] of 10 lb to 20 lb (4.5 kg to 9.1 kg).

5.6.5.3 Lightweight Class. Lightweight class shall be defined so as to include all papers having a basis weight [weight per 1000 ft² (92.9 m²)] of 10 lb (4.5 kg).

5.6.5.4 Tissue.

Copyright NFPA

5.6.5.4.1 Tissue shall be defined so as to include the broad range of papers of characteristic gauzy texture, which, in some cases, are fairly transparent.

5.6.5.4.2 For the purposes of this standard, tissue shall be defined as the soft, absorbent type, regardless of basis weight — specifically, crepe wadding and the sanitary class including facial tissue, paper napkins, bathroom tissue, and toweling.

Chapter 6 System Components and Hardware

6.1 General.

This chapter provides requirements for correct use of sprinkler system components.

6.1.1* Listing.

6.1.1.1 Materials or devices not specifically designated by this standard shall be used in accordance with all conditions, requirements, and limitations of their special listing. All special listing requirements shall be included and identified in the product submittal literature and installation instructions.

6.1.1.2 Unless the requirements of 6.1.1.3, 6.1.1.4, or 6.1.1.5 are met, all materials and devices essential to successful system operation shall be listed.

6.1.1.3 Equipment as permitted in Table 6.3.1.1 and Table 6.4.1 shall not be required to be listed.

6.1.1.4 Materials meeting the requirements of 9.1.1.2, 9.1.1.4.2, and 9.1.1.4.3 shall not be required to be listed.

6.1.1.5 Components that do not affect system performance such as drain piping, drain valves, and signs shall not be required to be listed.

6.1.2 Reconditioned Components.

6.1.2.1 The use of reconditioned valves and devices as replacement equipment in existing systems shall be permitted.

6.1.2.2 Reconditioned sprinklers shall not be permitted to be utilized on any new or existing system.

6.1.3 Rated Pressure. System components shall be rated for the maximum system working pressure to which they are exposed but shall not be rated at less than 175 psi (12.1 bar) for components installed aboveground and 150 psi (10.4 bar) for components installed underground.

6.2 Sprinklers.

6.2.1 General. Only new sprinklers shall be installed.

6.2.2* Sprinkler Identification.

6.2.2.1 All sprinklers shall be permanently marked with a one- or two-character

manufacturer symbol, followed by three or four numbers, so as to identify a unique sprinkler identification for every change in orifice size or shape, deflector characteristic, pressure rating, and thermal sensitivity.

6.2.3 Sprinkler Discharge Characteristics.

6.2.3.1* General. Unless the requirements of 6.2.3.2, 6.2.3.3, or 6.2.3.4 are met, the K-factor, relative discharge, and marking identification for sprinklers having different orifice sizes shall be in accordance with Table 6.2.3.1.

Table 6.2.3.1 Sprinkler Discharge Characteristics Identification

Nominal K-factor [gpm/(psi) ^{1/2}]	K-factor Range [gpm/(psi) ^{1/2}]	K-factor Range [dm ³ /min/(kPa) ^{1/2}]	Percent of Nominal K-5.6 Discharge	Thread Type
1.4	1.3–1.5	1.9–2.2	25	½ in. NPT
1.9	1.8–2.0	2.6–2.9	33.3	½ in. NPT
2.8	2.6–2.9	3.8–4.2	50	½ in. NPT
4.2	4.0–4.4	5.9–6.4	75	½ in. NPT
5.6	5.3–5.8	7.6–8.4	100	½ in. NPT
8.0	7.4–8.2	10.7–11.8	140	¾ in. NPT or ½ in. NPT
11.2	11.0–11.5	15.9–16.6	200	½ in. NPT or ¾ in. NPT
14.0	13.5–14.5	19.5–20.9	250	¾ in. NPT
16.8	16.0–17.6	23.1–25.4	300	¾ in. NPT
19.6	18.6–20.6	27.2–30.1	350	1 in. NPT
22.4	21.3–23.5	31.1–34.3	400	1 in. NPT
25.2	23.9–26.5	34.9–38.7	450	1 in. NPT
28.0	26.6–29.4	38.9–43.0	500	1 in. NPT

6.2.3.2 Pipe Threads. Listed sprinklers having pipe threads different from those shown in Table 6.2.3.1 shall be permitted.

6.2.3.3 K-Factors Greater Than 28. Sprinklers listed with nominal K-factors greater than 28 shall increase the flow by 100 percent increments when compared with a nominal K-5.6 sprinkler.

6.2.3.4 Residential Sprinklers. Residential sprinklers shall be permitted with K-factors other than those specified in Table 6.2.3.1.

6.2.3.5 Large Drop and ESFR K-Factors. Large drop and ESFR sprinklers shall have a minimum nominal K-factor of 11.2.

6.2.3.6 ESFR Orifice Size. ESFR sprinkler orifice size shall be selected as appropriate for the hazard. (*See Chapter 12.*)

6.2.4 Occupancy Limitations. Unless the requirements of 6.2.4.1 or 6.2.4.2 are met, sprinklers shall not be listed for protection of a portion of an occupancy classification.

6.2.4.1 Residential Sprinklers. Residential sprinklers shall be permitted to be listed for portions of residential occupancies as defined in 8.4.5.1.

6.2.4.2 Special Sprinklers. Special sprinklers shall be permitted to be listed for protection of a specific construction feature in a portion of an occupancy classification. (See 8.4.8.)

6.2.5* Temperature Characteristics.

6.2.5.1 Automatic sprinklers shall have their frame arms, deflector, coating material, or liquid bulb colored in accordance with the requirements of Table 6.2.5.1 or the requirements of 6.2.5.2, 6.2.5.3, 6.2.5.4, or 6.2.5.5.

Table 6.2.5.1 Temperature Ratings, Classifications, and Color Codings

Maximum Ceiling Temperature		Temperature Rating		Temperature Classification	Color Code	Glass Color
°F	°C	°F	°C			
100	38	135–170	57–77	Ordinary	Uncolored or black	Orange
150	66	175–225	79–107	Intermediate	White	Yellow
225	107	250–300	121–149	High	Blue	Blue
300	149	325–375	163–191	Extra high	Red	Purple
375	191	400–475	204–246	Very extra high	Green	Black
475	246	500–575	260–302	Ultra high	Orange	Black
625	329	650	343	Ultra high	Orange	Black

6.2.5.2 A dot on the top of the deflector, the color of the coating material, or colored frame arms shall be permitted for color identification of corrosion-resistant sprinklers.

6.2.5.3 Color identification shall not be required for ornamental sprinklers such as factory-plated or factory-painted sprinklers or for recessed, flush, or concealed sprinklers.

6.2.5.4 The frame arms of bulb-type sprinklers shall not be required to be color coded.

6.2.5.5 The liquid in bulb-type sprinklers shall be color coded in accordance with Table 6.2.5.1.

6.2.6 Special Coatings.

6.2.6.1* Corrosion Resistant.

6.2.6.1.1 Listed corrosion-resistant sprinklers shall be installed in locations where chemicals, moisture, or other corrosive vapors sufficient to cause corrosion of such devices exist.

6.2.6.1.2* Unless the requirements of 6.2.6.1.3 are met, corrosion-resistant coatings shall be applied only by the manufacturer of the sprinkler and in accordance with the requirements of 6.2.6.1.3.

6.2.6.1.3 Any damage to the protective coating occurring at the time of installation shall be repaired at once using only the coating of the manufacturer of the sprinkler in the approved manner so that no part of the sprinkler will be exposed after installation has been completed.

6.2.6.2* Painting.

6.2.6.2.1 Sprinklers shall only be painted by the sprinkler manufacturer.

6.2.6.2.2 Where sprinklers have had paint applied by other than the sprinkler manufacturer, they shall be replaced with new listed sprinklers of the same characteristics, including orifice size, thermal response, and water distribution.

6.2.6.3 Ornamental Finishes.

6.2.6.3.1 Ornamental finishes shall only be applied to sprinklers, and if applicable their concealed cover plates, by the sprinkler manufacturer.

6.2.6.3.2 Sprinklers shall be specifically listed with ornamental finishes where utilized.

6.2.6.4 Protective Coverings.

6.2.6.4.1 Sprinklers protecting spray areas and mixing rooms in resin application areas shall be protected against overspray residue so that they will operate in the event of fire.

6.2.6.4.2 Where protected in accordance with 6.2.6.4.1, cellophane bags having a thickness of 0.003 in. (0.076 mm) or less or thin paper bags shall be used.

6.2.6.4.3 Coverings shall be replaced periodically so that heavy deposits of residue do not accumulate.

6.2.6.4.4 Sprinklers that have been painted or coated shall be replaced in accordance with the requirements of 6.2.6.2.2.

6.2.7 Escutcheons and Cover Plates.

6.2.7.1 Nonmetallic escutcheons shall be listed.

6.2.7.2* Escutcheons used with recessed, flush-type, or concealed sprinklers shall be part of a listed sprinkler assembly.

6.2.7.3 Cover plates used with concealed sprinklers shall be part of the listed sprinkler assembly.

6.2.8 Guards. Sprinklers subject to mechanical injury shall be protected with listed guards.

6.2.9 Stock of Spare Sprinklers.

6.2.9.1* A supply of at least six spare sprinklers (never fewer than six) shall be maintained on the premises so that any sprinklers that have operated or been damaged in any way can be promptly replaced.

6.2.9.2 The sprinklers shall correspond to the types and temperature ratings of the sprinklers in the property.

6.2.9.3 The sprinklers shall be kept in a cabinet located where the temperature to which they

are subjected will at no time exceed 100°F (38°C).

6.2.9.4 Where dry sprinklers of different lengths are installed, spare dry sprinklers shall not be required, provided that a means of returning the system to service is furnished.

6.2.9.5 The stock of spare sprinklers shall include all types and ratings installed and shall be as follows:

- (1) For protected facilities having under 300 sprinklers — no fewer than six sprinklers
- (2) For protected facilities having 300 to 1000 sprinklers — no fewer than 12 sprinklers
- (3) For protected facilities having over 1000 sprinklers — no fewer than 24 sprinklers

6.2.9.6 A special sprinkler wrench shall be provided and kept in the cabinet to be used in the removal and installation of sprinklers. One sprinkler wrench shall be provided for each type of sprinkler installed.

6.2.9.7 A list of the sprinklers installed in the property shall be posted in the sprinkler cabinet.

6.2.9.7.1* The list shall include the following:

- (1) Sprinkler Identification Number (SIN) if equipped; or the manufacturer, model, orifice, deflector type, thermal sensitivity, and pressure rating
- (2) General description
- (3) Quantity of each type to be contained in the cabinet
- (4) Issue or revision date of the list

6.3 Aboveground Pipe and Tube.

6.3.1 General.

6.3.1.1 Pipe or tube shall meet or exceed one of the standards in Table 6.3.1.1 or be in accordance with 6.3.6.

Table 6.3.1.1 Pipe or Tube Materials and Dimensions

Materials and Dimensions	Standard
Ferrous Piping (Welded and Seamless)	
Specification for black and hot-dipped zinc-coated (galvanized) welded and seamless steel pipe for fire protection use	ASTM A 795
Specification for welded and seamless steel pipe	ANSI/ASTM A 53
Wrought steel pipe	ANSI/ASME B36.10M
Specification for electric-resistance-welded steel pipe	ASTM A 135

Copper Tube (Drawn, Seamless)

Table 6.3.1.1 Pipe or Tube Materials and Dimensions

Materials and Dimensions	Standard
Specification for seamless copper tube	ASTM B 75
Specification for seamless copper water tube	ASTM B 88
Specification for general requirements for wrought seamless copper and copper-alloy tube	ASTM B 251
Fluxes for soldering applications of copper and copper-alloy tube	ASTM B 813
Brazing filler metal (classification BCuP-3 or BCuP-4)	AWS A5.8
Solder metal, Section 1: Solder alloys containing less than 0.2% lead and having solidus temperatures greater than 400°F	ASTM B 32
Alloy materials	ASTM B 446

6.3.1.2 Steel pipe shall be in accordance with 6.3.2, 6.3.3, or 6.3.4.

6.3.1.3 Copper tube shall be in accordance with 6.3.5.

6.3.1.4 Chlorinated polyvinyl chloride (CPVC) shall be in accordance with 6.3.6 and with the portions of the ASTM standards specified in Table 6.3.6.1 that apply to fire protection service.

6.3.2* Steel Pipe — Welded or Roll-Grooved. When steel pipe referenced in Table 6.3.1.1 is used and joined by welding as referenced in 6.5.2 or by roll-grooved pipe and fittings as referenced in 6.5.3, the minimum nominal wall thickness for pressures up to 300 psi (20.7 bar) shall be in accordance with Schedule 10 for pipe sizes up to 5 in. (125 mm), 0.134 in. (3.40 mm) for 6 in. (150 mm) pipe, 0.188 in. (4.78 mm) for 8 and 10 in. (200 and 250 mm) pipe, and 0.330 in. (8.38 mm) for 12 in. (300 mm) pipe.

6.3.3 Steel Pipe — Threaded. When steel pipe referenced in Table 6.3.1.1 is joined by threaded fittings referenced in 6.5.1 or by fittings used with pipe having cut grooves, the minimum wall thickness shall be in accordance with Schedule 30 pipe [in sizes 8 in. (200 mm) and larger] or Schedule 40 pipe [in sizes less than 8 in. (200 mm)] for pressures up to 300 psi (20.7 bar).

6.3.4 Specially Listed Steel Pipe. Pressure limitations and wall thickness for steel pipe specially listed in accordance with 6.3.6 shall be permitted to be in accordance with the pipe listing requirements.

6.3.5* Copper Tube. Copper tube as specified in the standards listed in Table 6.3.1.1 shall have a wall thickness of Type K, Type L, or Type M where used in sprinkler systems.

6.3.6* Listed Pipe and Tubing.

6.3.6.1 Other types of pipe or tube investigated for suitability in automatic sprinkler installations and listed for this service, including but not limited to CPVC and steel, and differing from that provided in Table 6.3.1.1 or Table 6.3.6.1 shall be permitted where

6.3.6* Listed Pipe and Tubing.

6.3.6.1 Other types of pipe or tube investigated for suitability in automatic sprinkler installations and listed for this service, including but not limited to CPVC and steel, and differing from that provided in Table 6.3.1.1 or Table 6.3.6.1 shall be permitted where installed in accordance with their listing limitations, including installation instructions.

Table 6.3.6.1 Specially Listed Pipe or Tube Materials and Dimensions

Materials and Dimensions	Standard
Nonmetallic piping specification for special listed chlorinated polyvinyl chloride (CPVC) pipe	ASTM F 442

6.3.6.2 Pipe or tube listed for light hazard occupancies shall be permitted to be installed in ordinary hazard rooms of otherwise light hazard occupancies where the room does not exceed 400 ft² (37 m²).

6.3.6.3 Pipe or tube shall not be listed for portions of an occupancy classification.

6.3.6.4 Bending of listed pipe and tubing shall be permitted as allowed by the listing.

6.3.7 Pipe and Tube Bending.

6.3.7.1 Bending of Schedule 10 steel pipe, or any steel pipe of wall thickness equal to or greater than Schedule 10 and Types K and L copper tube, shall be permitted when bends are made with no kinks, ripples, distortions, or reductions in diameter or any noticeable deviations from round.

6.3.7.2 For Schedule 40 and copper tubing, the minimum radius of a bend shall be six pipe diameters for pipe sizes 2 in. (50 mm) and smaller and five pipe diameters for pipe sizes 2½ in. (65 mm) and larger.

6.3.7.3 For all other steel pipe, the minimum radius of a bend shall be 12 pipe diameters for all sizes.

6.3.8 Pipe and Tube Identification.

6.3.8.1 All pipe, including specially listed pipe allowed by 6.3.6, shall be marked along its length by the manufacturer in such a way as to properly identify the type of pipe. The marking shall be visible on every piece of pipe over 2 ft (610 mm) long.

6.3.8.2 Pipe identification shall include the manufacturer's name, model designation, or schedule.

6.4 Fittings.

6.4.1 Fittings used in sprinkler systems shall meet or exceed the standards in Table 6.4.1 or be in accordance with 6.4.2 or 6.4.3.

Table 6.4.1 Fittings Materials and Dimensions

Materials and Dimensions	Standard
Cast Iron	
Cast iron threaded fittings, Class 125 and 250	ASME B16.4
Cast iron pipe flanges and flanged fittings	ASME B16.1
Malleable Iron	
Malleable iron threaded fittings, Class 150 and 300 steel	ASME B16.3
Factory-made wrought steel buttweld fittings	ASME B16.9

Table 6.4.1 Fittings Materials and Dimensions

Materials and Dimensions	Standard
Buttwelding ends for pipe, valves, flanges, and fittings	ASME B16.25
Specification for piping fittings of wrought carbon steel and alloy steel for moderate and elevated temperatures	ASTM A 234
Steel pipe flanges and flanged fittings	ASME B16.5
Forged steel fittings, socket welded and threaded copper	ASME B16.11
Wrought copper and copper alloy solder joint pressure fittings	ASME B16.22
Cast copper alloy solder joint pressure fittings	ASME B16.18

6.4.2 In addition to the standards in Table 6.4.1, CPVC fittings shall also be in accordance with 6.4.3 and with the portions of the ASTM standards specified in Table 6.4.3 that apply to fire protection service.

6.4.3* Other types of fittings investigated for suitability in automatic sprinkler installations and listed for this service including, but not limited to, polybutylene, CPVC, and steel differing from that provided in Table 6.4.3, shall be permitted when installed in accordance with their listing limitations, including installation instructions.

Table 6.4.3 Specially Listed Fittings Materials and Dimensions

Materials and Dimensions	Standard
Chlorinated polyvinyl chloride (CPVC) specification for Schedule 80 CPVC threaded fittings	ASTM F 437
Specification for Schedule 40 CPVC socket-type fittings	ASTM F 438
Specification for Schedule 80 CPVC socket-type fittings	ASTM F 439

6.4.4* Fitting Pressure Limits.

6.4.4.1 Standard weight pattern cast-iron fittings 2 in. (50 mm) in size and smaller shall be permitted where pressures do not exceed 300 psi (20.7 bar).

6.4.4.2 Standard weight pattern malleable iron fittings 6 in. (150 mm) in size and smaller shall be permitted where pressures do not exceed 300 psi (20.7 bar).

6.4.4.3 Listed fittings shall be permitted for system pressures up to the limits specified in their listings.

6.4.4.4 Fittings not meeting the requirements of 6.4.4.1 through 6.4.4.3 shall be extra-heavy pattern where pressures exceed 175 psi (12.1 bar).

6.4.5* Couplings and Unions.

6.4.5.1 Screwed unions shall not be used on pipe larger than 2 in. (50 mm).

6.4.5.2 Couplings and unions of other than screwed-type shall be of types listed specifically for use in sprinkler systems.

6.4.6 Reducers and Bushings.

6.4.6.1 Unless the requirements of 6.4.6.2 or 6.4.6.3 are met, a one-piece reducing fitting shall be used wherever a change is made in the size of the pipe.

6.4.6.2 Hexagonal or face bushings shall be permitted in reducing the size of openings of fittings when standard fittings of the required size are not available.

6.4.6.3 Hexagonal bushings as permitted in 8.15.19.2 shall be permitted to be used.

6.5 Joining of Pipe and Fittings.

6.5.1 Threaded Pipe and Fittings.

6.5.1.1 All threaded pipe and fittings shall have threads cut to ASME B1.20.1, *Pipe Threads, General Purpose (Inch)*.

6.5.1.2* Steel pipe with wall thicknesses less than Schedule 30 [in sizes 8 in. (200 mm) and larger] or Schedule 40 [in sizes less than 8 in. (200 mm)] shall only be permitted to be joined by threaded fittings where the threaded assembly is investigated for suitability in automatic sprinkler installations and listed for this service.

6.5.1.3 Joint compound or tape shall be applied only to male threads.

6.5.2 Welded Pipe and Fittings.

6.5.2.1 General.

6.5.2.1.1 Welding shall be permitted as a means of joining sprinkler piping in accordance with 6.5.2.2 through 6.5.2.6

6.5.2.2* Fabrication.

6.5.2.2.1 When welding sprinkler pipe, the pipe shall be shop welded unless the requirements of 6.5.2.2 or 6.5.2.3 are met.

6.5.2.2.2 Where the design specifications require any part of the piping system to be welded in place, welding of sprinkler piping shall be permitted where the welding process is performed in accordance with NFPA 51B, *Standard for Fire Prevention During Welding, Cutting, and Other Hot Work*, and the mechanical fittings required by 8.15.21 and 8.16.3 are provided.

6.5.2.2.3 Tabs for longitudinal earthquake bracing shall be permitted to be welded to in-place piping where the welding process is performed in accordance with NFPA 51B, *Standard for Fire Prevention During Welding, Cutting, and Other Hot Work*.

6.5.2.2.4 Welding shall not be performed where there is impingement of rain, snow, sleet, or high wind on the weld area of the pipe product.

6.5.2.2.5 Torch cutting and welding shall not be permitted as a means of modifying or repairing sprinkler systems.

6.5.2.3 Fittings.

6.5.2.3.1* Welded fittings used to join pipe shall be listed fabricated fittings or manufactured in accordance with Table 6.4.1.

6.5.2.3.2 Fittings referenced in 6.5.2.3.1 shall be joined in conformance with a qualified welding procedure as set forth in this section and shall be an acceptable product under this standard, provided that materials and wall thickness are compatible with other sections of this standard.

6.5.2.3.3 Fittings shall not be required where pipe ends are butt welded in accordance with the requirements of 6.5.2.4.2.

6.5.2.3.4 When the pipe size in a run of piping is reduced, a reducing fitting designed for that purpose shall be used in accordance with the requirements of 6.5.2.3.1.

6.5.2.4 Welding Requirements.

6.5.2.4.1* Welds between pipe and welding outlet fittings shall be permitted to be attached by full penetration welds, partial penetration groove welds, or fillet welds. The minimum throat thickness shall be not less than the thickness of the pipe, the thickness of the welding fitting, or $\frac{3}{16}$ in. (4.8 mm), whichever is least.

6.5.2.4.2* Circumferential butt joints shall be cut, beveled, and fit so that full penetration is achievable. Full penetration welding shall not be required.

6.5.2.4.3 Where slip-on flanges are welded to pipe with a single fillet weld, the weld shall be on the hub side of the flange and the minimum throat weld thickness shall not be less than 1.25 times the pipe wall thickness or the hub thickness, whichever is less.

6.5.2.4.4 Face welds on the internal face of the flange shall be permitted as a water seal in addition to the hub weld required in 6.5.2.4.3.

6.5.2.4.5 Tabs for longitudinal earthquake bracing shall have minimum throat weld thickness not less than 1.25 times the pipe wall thickness and welded on both sides of the longest dimension.

6.5.2.4.6 When welding is performed, the following shall apply:

- (1) Holes in piping for outlets shall be cut to the full inside diameter of fittings prior to welding in place of the fittings.
- (2) Discs shall be retrieved.
- (3) Openings cut into piping shall be smooth bore, and all internal slag and welding residue shall be removed.
- (4) Fittings shall not penetrate the internal diameter of the piping.
- (5) Steel plates shall not be welded to the ends of piping or fittings.

- (6) Fittings shall not be modified.
- (7) Nuts, clips, eye rods, angle brackets, or other fasteners shall not be welded to pipe or fittings, except as permitted in 6.5.2.2.3 and 6.5.2.4.5.
- (8) Completed welds shall be free from cracks, incomplete fusion, surface porosity greater than $\frac{1}{16}$ in. (1.6 mm) diameter, and undercut deeper than 25 percent of the wall thickness or $\frac{1}{32}$ in. (0.8 mm), whichever is less.
- (9) Completed circumferential butt weld reinforcement shall not exceed $\frac{3}{32}$ in. (2.4 mm).

6.5.2.5 Qualifications.

6.5.2.5.1 A welding procedure shall be prepared and qualified by the contractor or fabricator before any welding is done.

6.5.2.5.2 Qualification of the welding procedure to be used and the performance of all welders and welding operators shall be required and shall meet or exceed the requirements of AWS B2.1, *Specification for Welding Procedure and Performance Qualification*, ASME *Boiler and Pressure Vessel Code*, Section IX, *Welding and Brazing Qualifications*, or other applicable qualification standard as required by the authority having jurisdiction, except as permitted by 6.5.2.5.3.

6.5.2.5.3 Successful procedure qualification of complete joint penetration groove welds shall qualify partial joint penetration (groove/fillet) welds and fillet welds in accordance with the provisions of this standard.

6.5.2.5.4 Welding procedures qualified under standards recognized by previous editions of this standard shall be permitted to be continued in use.

6.5.2.5.5 Contractors or fabricators shall be responsible for all welding they produce.

6.5.2.5.6 Each contractor or fabricator shall have available to the authority having jurisdiction an established written quality assurance procedure ensuring compliance with the requirements of 6.5.2.4.

6.5.2.6 Records.

6.5.2.6.1 Welders or welding machine operators shall, upon completion of each welded pipe, place their identifiable mark or label onto each piece adjacent to a weld.

6.5.2.6.2 Contractors or fabricators shall maintain certified records, which shall be available to the authority having jurisdiction, of the procedures used and the welders or welding machine operators employed by them, along with their welding identification.

6.5.2.6.3 Records shall show the date and the results of procedure and performance qualifications.

6.5.3 Groove Joining Methods.

6.5.3.1 Pipe joined with grooved fittings shall be joined by a listed combination of fittings, gaskets, and grooves.

6.5.3.2 Grooves cut or rolled on pipe shall be dimensionally compatible with the fittings.

6.5.3.3 Grooved fittings, including gaskets used on dry-pipe, preaction, and deluge systems, shall be listed for dry pipe service.

6.5.4* Brazed and Soldered Joints.

6.5.4.1 Solder joints, where permitted, shall be fabricated in accordance with the methods and procedures listed in ASTM B 828, *Standard Practice for Making Capillary Joints by Soldering of Copper and Copper Alloy Tube and Fittings*.

6.5.4.2 Unless the requirements of 6.5.4.3 or 6.5.4.4 are met, joints for the connection of copper tube shall be brazed.

6.5.4.3 Solder joints shall be permitted for exposed wet pipe systems in light hazard occupancies where the temperature classification of the installed sprinklers is of the ordinary- or intermediate-temperature classification.

6.5.4.4 Solder joints shall be permitted for wet pipe systems in light hazard and ordinary hazard (Group 1) occupancies where the piping is concealed, irrespective of sprinkler temperature ratings.

6.5.4.5* Soldering fluxes shall be in accordance with Table 6.3.1.1.

6.5.4.6 Brazing fluxes, if used, shall not be of a highly corrosive type.

6.5.5 Other Joining Methods.

6.5.5.1 Other joining methods investigated for suitability in automatic sprinkler installations and listed for this service shall be permitted where installed in accordance with their listing limitations, including installation instructions.

6.5.5.2 Outlet Fittings. Rubber-gasketed outlet fittings that are used on sprinkler systems shall meet the following requirements:

- (1) Be installed in accordance with the listing and manufacturer's installation instructions
- (2) Have all disks retrieved
- (3) Have smooth bores cut into the pipe, with all cutting residue removed
- (4) Not be modified

6.5.6 End Treatment.

6.5.6.1 After cutting, pipe ends shall have burrs and fins removed.

6.5.6.2 Pipe used with listed fittings and its end treatment shall be in accordance with the fitting manufacturer's installation instructions and the fitting's listing.

6.6* Hangers.

Hangers shall be in accordance with the requirements of Section 9.1.

6.7 Valves.

Copyright NFPA

6.7.1 General.

6.7.1.1 Valve Pressure Requirements. When water pressures exceed 175 psi (12.1 bar), valves shall be used in accordance with their pressure ratings.

6.7.1.2 Valve Closure Time. Listed indicating valves shall not close in less than 5 seconds when operated at maximum possible speed from the fully open position.

6.7.1.3 Listed Indicating Valves. Unless the requirements of 6.7.1.3.1, 6.7.1.3.2, or 6.7.1.3.3 are met, all valves controlling connections to water supplies and to supply pipes to sprinklers shall be listed indicating valves.

6.7.1.3.1 A listed underground gate valve equipped with a listed indicator post shall be permitted.

6.7.1.3.2 A listed water control valve assembly with a reliable position indication connected to a remote supervisory station shall be permitted.

6.7.1.3.3 A nonindicating valve, such as an underground gate valve with approved roadway box, complete with T-wrench, and where accepted by the authority having jurisdiction, shall be permitted.

6.7.2 Wafer-Type Valves. Wafer-type valves with components that extend beyond the valve body shall be installed in a manner that does not interfere with the operation of any system components.

6.7.3 Drain Valves and Test Valves. Drain valves and test valves shall be approved.

6.7.4* Identification of Valves.

6.7.4.1 All control, drain, and test connection valves shall be provided with permanently marked weatherproof metal or rigid plastic identification signs.

6.7.4.2 The identification sign shall be secured with corrosion-resistant wire, chain, or other approved means.

6.7.4.3 The control valve sign shall identify the portion of the building served.

6.7.4.3.1* Systems that have more than one control valve that must be closed to work on a system or space shall have a sign referring to existence and location of other valves.

6.8 Fire Department Connections.

6.8.1* Unless the requirements of 6.8.1.1, 6.8.1.2, or 6.8.1.3 are met, the fire department connection(s) shall consist of two 2½ in. (65 mm) connections using NH internal threaded swivel fitting(s) with “2.5-7.5 NH standard thread,” as specified in NFPA 1963, *Standard for Fire Hose Connections*.

6.8.1.1 Where local fire department connections do not conform to NFPA 1963, *Standard for Fire Hose Connections*, the authority having jurisdiction shall be permitted to designate the connection to be used.

6.8.1.2 The use of threadless couplings shall be permitted where required by the authority

having jurisdiction and where listed for such use.

6.8.1.3 A single-outlet fire department connection shall be acceptable where piped to a 3 in. (80 mm) or smaller riser.

6.8.2 Fire department connections shall be equipped with approved plugs or caps, properly secured and arranged for easy removal by fire departments.

6.8.3 Fire department connections shall be of an approved type.

6.9 Waterflow Alarm Devices.

6.9.1 General. Waterflow alarm devices shall be listed for the service and so constructed and installed that any flow of water from a sprinkler system equal to or greater than that from a single automatic sprinkler of the smallest orifice size installed on the system will result in an audible alarm on the premises within 5 minutes after such flow begins and until such flow stops.

6.9.2 Waterflow Detecting Devices.

6.9.2.1 Wet Pipe Systems. The alarm apparatus for a wet pipe system shall consist of a listed alarm check valve or other listed waterflow-detecting alarm device with the necessary attachments required to give an alarm.

6.9.2.2 Dry Pipe Systems.

6.9.2.2.1 The alarm apparatus for a dry pipe system shall consist of listed alarm attachments to the dry pipe valve.

6.9.2.2.2 Where a dry pipe valve is located on the system side of an alarm valve, connection of the actuating device of the alarms for the dry pipe valve to the alarms on the wet pipe system shall be permitted.

6.9.2.3 Preaction and Deluge Systems. The alarm apparatus for deluge and preaction systems shall consist of alarms actuated independently by the detection system and the flow of water.

6.9.2.3.1 Deluge and preaction systems activated by pilot sprinklers shall not require an independent detection system alarm.

6.9.2.4* Paddle-Type Waterflow Devices. Paddle-type waterflow alarm indicators shall be installed in wet systems only.

6.9.3 Attachments — General.

6.9.3.1* An alarm unit shall include a listed mechanical alarm, horn, or siren or a listed electric gong, bell, speaker, horn, or siren.

6.9.3.2* Outdoor water motor-operated or electrically operated bells shall be weatherproofed and guarded.

6.9.3.3 All piping to water motor-operated devices shall be galvanized or brass or other corrosion-resistant material acceptable under this standard and of a size not less than $\frac{3}{4}$ in.

(20 mm).

6.9.3.4 Piping between the sprinkler system and a pressure-actuated alarm-initiating device shall be galvanized or of nonferrous metal or other approved corrosion-resistant material of not less than $\frac{3}{8}$ in. (10 mm) nominal pipe size.

6.9.4* Attachments — Electrically Operated.

6.9.4.1 Electrically operated alarm attachments forming part of an auxiliary, central station, local protective, proprietary, or remote station signaling system shall be installed in accordance with *NFPA 72, National Fire Alarm Code*.

6.9.4.2 Sprinkler waterflow alarm systems that are not part of a required protective signaling system shall not be required to be supervised and shall be installed in accordance with *NFPA 70, National Electrical Code*, Article 760.

6.9.4.3 Outdoor electric alarm devices shall be listed for outdoor use.

6.9.5 Alarm Device Drains. Drains from alarm devices shall be so arranged that there will be no overflowing at the alarm apparatus, at domestic connections, or elsewhere with the sprinkler drains wide open and under system pressure. (*See 8.16.2.6.*)

Chapter 7 System Requirements

7.1 Wet Pipe Systems.

7.1.1 Pressure Gauges.

7.1.1.1 A listed pressure gauge conforming to 8.17.3 shall be installed in each system riser.

7.1.1.2 Pressure gauges shall be installed above and below each alarm check valve or system riser check valve where such devices are present.

7.1.2 Relief Valves.

7.1.2.1 Unless the requirements of 7.1.2.2 are met, a gridded wet pipe system shall be provided with a relief valve not less than $\frac{1}{4}$ in. (6 mm) in size and set to operate at 175 psi (12.1 bar) or 10 psi (0.7 bar) in excess of the maximum system pressure, whichever is greater.

7.1.2.2 Where auxiliary air reservoirs are installed to absorb pressure increases, a relief valve shall not be required.

7.1.3 Auxiliary Systems. A wet pipe system shall be permitted to supply an auxiliary dry pipe, preaction, or deluge system, provided the water supply is adequate.

7.2* Dry Pipe Systems.

7.2.1 Pressure Gauges. Listed pressure gauges conforming with 8.17.3 shall be connected as follows:

- (1) On the water side and air side of the dry pipe valve

- (2) At the air pump supplying the air receiver where one is provided
- (3) At the air receiver where one is provided
- (4) In each independent pipe from air supply to dry pipe system
- (5) At exhausters and accelerators

7.2.2 Sprinklers. The following types of sprinklers and arrangements shall be permitted for dry pipe systems:

- (1) Upright sprinklers
- (2)* Listed dry sprinklers
- (3) Pendent sprinklers and sidewall sprinklers installed on return bends, where the sprinklers, return bend, and branch line piping are in an area maintained at or above 40°F (4°C)
- (4) Horizontal sidewall sprinklers, installed so that water is not trapped
- (5) Pendent sprinklers and sidewall sprinklers, where the sprinklers and branch line piping are in an area maintained at or above 40°F (4°C), the water supply is potable, and the piping for the dry pipe system is copper or CPVC specifically listed for dry pipe applications

7.2.3* Size of Systems.

7.2.3.1* The system capacity (volume) controlled by a dry pipe valve shall be determined by 7.2.3.2, 7.2.3.3, 7.2.3.4, 7.2.3.5, or 7.2.3.7. Dry-pipe systems protecting dwelling unit portions of any occupancy shall not be permitted to use the options outlined in 7.2.3.3 or 7.2.3.4 .

The text of 7.2.3.1 has been revised by a tentative interim amendment (TIA). See page 1.
--

7.2.3.2 System size shall be such that initial water is discharged from the system test connection in not more than 60 seconds, starting at the normal air pressure on the system and at the time of fully opened inspection test connection.

7.2.3.3 A system size of not more than 500 gal (1893 L) shall be permitted without a quick opening device and shall not be required to meet any specific water delivery requirement to the inspection test connection.

7.2.3.4 A system size of not more than 750 gal (2839 L) shall be permitted with a quick opening device and shall not be required to meet any specific water delivery requirement to the inspection test connection.

7.2.3.5 System size shall be based on dry systems being calculated for water delivery in accordance with 7.2.3.6.

7.2.3.6 Dry System Water Delivery.

7.2.3.6.1 Calculations for dry system water delivery shall be based on the hazard shown in

7.2.3.5 System size shall be based on dry systems being calculated for water delivery in accordance with 7.2.3.6.

7.2.3.6 Dry System Water Delivery.

7.2.3.6.1 Calculations for dry system water delivery shall be based on the hazard shown in Table 7.2.3.6.1.

Table 7.2.3.6.1 Dry System Water Delivery

Hazard	Number of Most Remote Sprinklers Initially Open	Maximum Time of Water Delivery
Residential	1	15 seconds
Light	1	60 seconds
Ordinary I	2	50 seconds
Ordinary II	2	50 seconds
Extra I	4	45 seconds
Extra II	4	45 seconds
High piled	4	40 seconds

7.2.3.6.2 The calculation program and method shall be listed by a nationally recognized testing laboratory.

7.2.3.7* System size shall be such that initial water discharge at system test valve or manifold outlet is not more than those in Table 7.2.3.6.1, starting at normal air pressure on the system and at the time of fully opened test connection. When flow is from four sprinklers, the test manifold shall be arranged to simulate two sprinklers on each of two sprinkler branch lines. A system meeting the requirements of this section shall not be required to also meet the requirements of 7.2.3.2 or 7.2.3.5.

7.2.3.8 Dry pipe systems with water delivery times other than 7.2.3.2, 7.2.3.5, and 7.2.3.7 shall be acceptable where listed by a nationally recognized testing laboratory.

7.2.3.9 Check valves shall not be used to subdivide the dry pipe systems.

7.2.3.10 Gridded dry pipe systems shall not be installed.

7.2.4 Quick-Opening Devices.

7.2.4.1 A listed quick-opening device shall be permitted to help meet the requirements of 7.2.3.2, 7.2.3.5, 7.2.3.7, or 7.2.3.8..

7.2.4.2 The quick-opening device shall be located as close as practical to the dry pipe valve.

7.2.4.3 To protect the restriction orifice and other operating parts of the quick-opening device against submergence, the connection to the riser shall be above the point at which water (priming water and back drainage) is expected when the dry pipe valve and quick-opening device are set, except where design features of the particular quick-opening device make these requirements unnecessary.

7.2.4.4 An indicating valve shall be installed in the connection between a dry pipe sprinkler riser and a quick-opening device. The valve shall be supervised in accordance with 8.16.1.1.2.

7.2.4.5 A check valve shall be installed between the quick-opening device and the intermediate chamber of the dry pipe valve, where the quick-opening device requires protection against submergence after system operation.

7.2.4.6 If the quick-opening device requires pressure feedback from the intermediate chamber, a valve type that will clearly indicate whether it is opened or closed shall be permitted in place of that check valve.

7.2.4.7 Where a valve is utilized in accordance with 7.2.4.6, the valve shall be constructed so that it can be locked or sealed in the open position.

7.2.4.8 Antiflooding Device.

7.2.4.8.1 Unless the requirements of 7.2.4.8.2 are met, a listed antiflooding device shall be installed in the connection between the dry pipe sprinkler riser and the quick-opening device.

7.2.4.8.2 A listed antiflooding device shall not be required where the quick-opening device

has built-in antiflooding design features.

7.2.5* Location and Protection of Dry Pipe Valve.

7.2.5.1* General. The dry pipe valve and supply pipe shall be protected against freezing and mechanical injury.

7.2.5.2 Valve Rooms.

7.2.5.2.1 Valve rooms shall be lighted and heated.

7.2.5.2.2 The source of heat shall be of a permanently installed type.

7.2.5.2.3 Heat tape shall not be used in lieu of heated valve enclosures to protect the dry pipe valve and supply pipe against freezing.

7.2.5.3 Supply. The supply for the sprinkler in the dry pipe valve enclosure shall be from the dry side of the system.

7.2.5.4 High Water Level Protection.

7.2.5.4.1 Protection against occurrence of water above the clapper shall be permitted where it is possible to reseal the dry valve after actuation without first draining the system. Protection shall be in accordance with 7.2.5.4.3.

7.2.5.4.2 Low Differential Dry Pipe Valve. Protection against accumulation of water above the clapper shall be provided for low differential dry pipe valves in accordance with 7.2.5.4.3.

7.2.5.4.3 High Water Level Device. An automatic high water level signaling device or an automatic drain shall be permitted.

7.2.6 Air Pressure and Supply.

7.2.6.1 Maintenance of Air Pressure. Air or nitrogen pressure shall be maintained on dry pipe systems throughout the year.

7.2.6.2* Air Supply.

7.2.6.2.1 The compressed air supply shall be from a source available at all times.

7.2.6.2.2* The air supply shall have a capacity capable of restoring normal air pressure in the system within 30 minutes.

7.2.6.2.3 The requirements of 7.2.6.2.2 shall not apply in refrigerated spaces maintained below 5°F (–15°C), where normal system air pressure shall be permitted to be restored within 60 minutes.

7.2.6.3 Air Supply Connections.

7.2.6.3.1 Connection pipe from the air supply to the dry pipe valve shall not be less than ½ in. (15 mm) in diameter and shall enter the system above the priming water level of the dry pipe valve.

7.2.6.3.2 A check valve shall be installed in the air filling connection, and a listed or

approved shutoff valve of either the renewable disc or ball valve type shall be installed on the supply side of this check valve and shall remain closed unless filling the system.

7.2.6.4 Relief Valve. An approved relief valve shall be provided between the air supply and the shutoff valve and shall be set to relieve pressure no less than 10 psi (0.7 bar) in excess of system air pressure provided in 7.2.6.6.1 and shall not exceed the manufacturer's limitations.

7.2.6.5 Automatic Air Maintenance.

7.2.6.5.1 Unless the requirements of 7.2.6.5.2 are met, where the air supply to a dry pipe system is maintained automatically, the air supply shall be from a dependable plant system or an air compressor with an air receiver, and shall utilize an air maintenance device specifically listed for such service and capable of controlling the required air pressure on, and maximum airflow to, the dry system.

7.2.6.5.2 Where the air compressor supplying the dry pipe system has a capacity less than 5.5 ft³/min (156 L/min) at 10 psig (0.7 bar), no air receiver or air maintenance device shall be required.

7.2.6.5.3 The automatic air supply to more than one dry pipe system shall be connected to enable individual maintenance of air pressure in each system.

7.2.6.5.4 A check valve or other positive backflow prevention device shall be installed in the air supply to each system to prevent airflow or waterflow from one system to another.

7.2.6.6 System Air Pressure.

7.2.6.6.1 The system air pressure shall be maintained in accordance with the instruction sheet furnished with the dry pipe valve, or shall be 20 psi (1.4 bar) in excess of the calculated trip pressure of the dry pipe valve, based on the highest normal water pressure of the system supply.

7.2.6.6.2 The permitted rate of air leakage shall be as specified in 24.2.2.

7.2.6.7 Nitrogen. Where used, nitrogen shall be introduced through a pressure regulator and shall be in accordance with 7.2.6.5.

7.3 Preaction Systems and Deluge Systems.

7.3.1* General.

7.3.1.1* All components of pneumatic, hydraulic, or electrical systems shall be compatible.

7.3.1.2 The automatic water control valve shall be provided with hydraulic, pneumatic, or mechanical manual means for operation that is independent of detection devices and of the sprinklers.

7.3.1.3 Pressure Gauges. Listed pressure gauges conforming with 8.17.3 shall be installed as follows:

- (1) Above and below preaction valve and below deluge valve
- (2) On air supply to preaction and deluge valves

7.3.1.4 A supply of spare fusible elements for heat-responsive devices, not less than two of each temperature rating, shall be maintained on the premises for replacement purposes.

7.3.1.5 Hydraulic release systems shall be designed and installed in accordance with manufacturer's requirements and listing for height limitations above deluge valves or deluge valve actuators to prevent water column.

7.3.1.6 Location and Spacing of Releasing Devices.

7.3.1.6.1 Spacing of releasing devices, including automatic sprinklers used as releasing devices, shall be in accordance with their listing and manufacturer's specifications.

7.3.1.6.2 The release system shall serve all areas that the preaction system protects.

7.3.1.6.3 Where thermal activation is utilized, the activation temperature of the release system shall be lower than the activation temperature of the sprinkler.

7.3.1.7 Devices for Test Purposes and Testing Apparatus.

7.3.1.7.1 Where detection devices installed in circuits are located where not readily accessible for testing, an additional detection device shall be provided on each circuit for test purposes at an accessible location and shall be connected to the circuit at a point that will ensure a proper test of the circuit.

7.3.1.7.2 Testing apparatus capable of producing the heat or impulse necessary to operate any normal detection device shall be furnished to the owner of the property with each installation.

7.3.1.7.3 Where explosive vapors or materials are present, hot water, steam, or other methods of testing not involving an ignition source shall be used.

7.3.1.8 Location and Protection of System Water Control Valves.

7.3.1.8.1 System water control valves and supply pipes shall be protected against freezing and mechanical injury.

7.3.1.8.2 Valve Rooms.

7.3.1.8.2.1 Valve rooms shall be lighted and heated.

7.3.1.8.2.2 The source of heat shall be of a permanently installed type.

7.3.1.8.2.3 Heat tape shall not be used in lieu of heated valve enclosure rooms to protect preaction and deluge valves and supply pipe against freezing.

7.3.2 Preaction Systems.

7.3.2.1 Preaction systems shall be one of the following types:

- (1) A single interlock system, which admits water to sprinkler piping upon operation of detection devices
- (2) A non-interlock system, which admits water to sprinkler piping upon operation of detection devices or automatic sprinklers

- (3) A double interlock system, which admits water to sprinkler piping upon operation of both detection devices and automatic sprinklers

7.3.2.2 Size of Systems — Single and Non-Interlock Preaction Systems. Not more than 1000 automatic sprinklers shall be controlled by any one preaction valve.

7.3.2.3 Size of Systems — Double Interlock Preaction Systems.

7.3.2.3.1 The system size controlled by a double interlock preaction valve shall be determined by either 7.3.2.3.1.1, 7.3.2.3.1.2, or 7.3.2.3.1.3.

7.3.2.3.1.1 The system size for double interlock preaction systems shall be designed to deliver water to the system test connection in no more than 60 seconds, starting at the normal air pressure on the system, with the detection system activated and the inspection test connection fully opened simultaneously.

7.3.2.3.1.2 The system size for double interlock preaction systems shall be based on calculating water delivery in accordance with 7.2.3.6, anticipating that the detection system activation and sprinkler operation will be simultaneous.

7.3.2.3.1.3 The system size for double interlock preaction systems shall be designed to deliver water to the system test connection in no more than 60 seconds, starting at the normal air pressure on the system, with the detection system activated and the inspection test connection manifold, arranged to comply with Table 7.2.3.6.1, opened simultaneously.

7.3.2.3.2 A listed quick-opening device shall be permitted to be used to help meet the requirements of 7.3.2.3.1.1, 7.3.2.3.1.2, and 7.3.2.3.1.3.

7.3.2.4* Supervision.

7.3.2.4.1 Sprinkler piping and fire detection devices shall be automatically supervised where there are more than 20 sprinklers on the system.

7.3.2.4.2 Except as permitted by 7.3.2.4.3, air or nitrogen supervising pressure for preaction systems shall be installed in conformance with the dry pipe system air pressure and supply rules of 7.2.6.

7.3.2.4.3 The relief valves required by 7.2.6 shall be permitted to be omitted for the type of preaction system described in 7.3.2.1(1) when the air pressure is supplied from a source that is not capable of developing pressures in excess of 15 psi (1.0 bar).

7.3.2.4.4 All preaction system types described in 7.3.2.1(2) and 7.3.2.1(3) shall maintain a minimum supervising air or nitrogen pressure of 7 psi (0.5 bar).

7.3.2.5 Sprinklers. The following types of sprinklers and arrangements shall be permitted for preaction systems:

- (1) Upright sprinklers
- (2)* Listed dry sprinklers
- (3) Pendent sprinklers and sidewall sprinklers installed on return bends, where the sprinklers, return bend, and branch line piping are in an area maintained at or above

40°F (4°C)

- (4) Horizontal sidewall sprinklers, installed so that water is not trapped
- (5) Pendent sprinklers and sidewall sprinklers, where the sprinklers and branch line piping are in an area maintained at or above 40°F (4°C), the water supply is potable, and the piping for the pre-action system is copper or CPVC specifically listed for dry pipe applications

7.3.2.6 System Configuration. Preaction systems of the type described in 7.3.2.1(3) and all preaction systems protecting storage occupancies, excluding miscellaneous storage, shall not be gridded.

7.3.3* Deluge Systems.

7.3.3.1 The detection devices or systems shall be automatically supervised.

7.3.3.2 Deluge systems shall be hydraulically calculated.

7.4 Combined Dry Pipe and Preaction Systems for Piers, Terminals, and Wharves.

7.4.1 In addition to the requirements of Section 7.4, design and installation requirements for piers, terminals, and wharves shall be in accordance with Section 21.25.

7.4.2* General.

7.4.2.1* Combined automatic dry pipe and preaction systems shall be so constructed that failure of the detection system shall not prevent the system from functioning as a conventional automatic dry pipe system.

7.4.2.2 Combined automatic dry pipe and preaction systems shall be so constructed that failure of the dry pipe system of automatic sprinklers shall not prevent the detection system from properly functioning as an automatic fire alarm system.

7.4.2.3 Provisions shall be made for the manual operation of the detection system at locations requiring not more than 200 ft (61 m) of travel.

7.4.2.4 Sprinklers. The following types of sprinklers and arrangements shall be permitted for combined dry pipe and preaction systems:

- (1) Upright sprinklers
- (2)* Listed dry sprinklers
- (3) Pendent sprinklers and sidewall sprinklers installed on return bends, where both the sprinklers and the return bends are located in a heated area
- (4) Horizontal sidewall sprinklers, installed so that water is not trapped

7.4.3 Dry Pipe Valves in Combined Systems.

7.4.3.1 Where the system consists of more than 600 sprinklers or has more than 275 sprinklers in any fire area, the entire system shall be controlled through two 6 in. (150 mm) dry pipe valves connected in parallel and shall feed into a common feed main.

7.4.3.2 Where parallel dry pipe valves are required by 7.4.3.1, these valves shall be checked against each other. (*See Figure 7.4.3.2.*)

Tubing or wiring to fire detection system

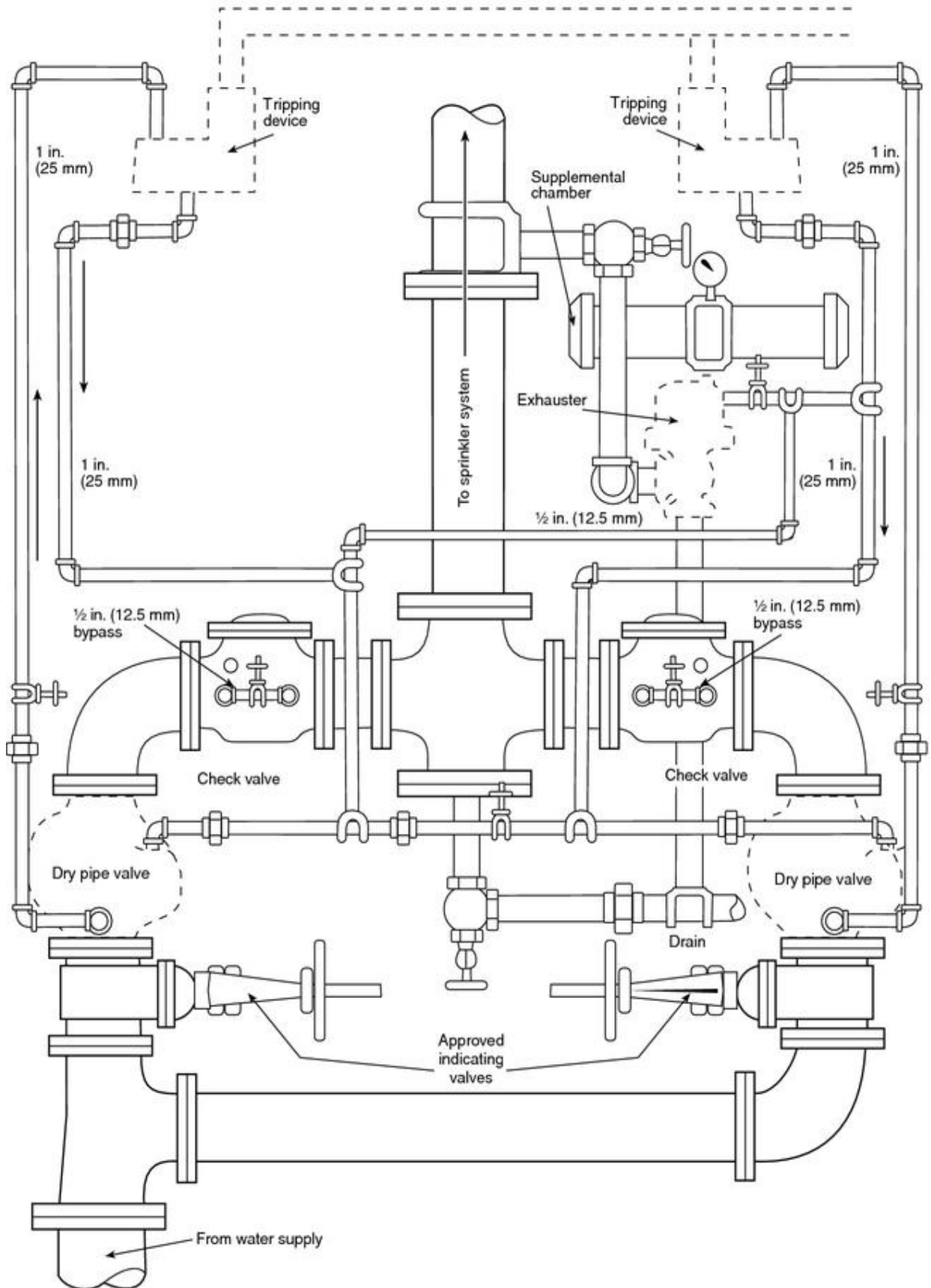

FIGURE 7.4.3.2 Header for Dry Pipe Valves Installed in Parallel for Combined Systems; Standard Trimmings Not Shown. Arrows Indicate Direction of Fluid Flow.

7.4.3.3 Each dry pipe valve shall be provided with a listed tripping device actuated by the detection system.

7.4.3.4 Dry pipe valves shall be cross-connected through a 1 in. (25 mm) pipe connection to permit simultaneous tripping of both dry pipe valves.

7.4.3.5 The 1 in. (25 mm) cross-connection pipe shall be equipped with an indicating valve so that either dry pipe valve can be shut off and worked on while the other remains in service.

7.4.3.6 The check valves between the dry pipe valves and the common feed main shall be equipped with ½ in. (15 mm) bypasses so that a loss of air from leakage in the trimmings of a dry pipe valve will not cause the valve to trip until the pressure in the feed main is reduced to the tripping point.

7.4.3.7 An indicating valve shall be installed in each of these bypasses so that either dry pipe valve can be completely isolated from the main riser or feed main and from the other dry pipe valve.

7.4.3.8 Each combined dry pipe and preaction system shall be provided with listed quick-opening devices at the dry pipe valves.

7.4.4* Exhausters.

7.4.4.1 One or more listed exhausters of 2 in. (50 mm) or larger size controlled by operation of a fire detection system shall be installed at the end of the common feed main.

7.4.4.2 These air exhaust valves shall have soft-seated globe or angle valves in their intakes.

7.4.4.3 Approved strainers shall be installed between the globe valves and the air exhaust valves.

7.4.5 Subdivision of System Using Check Valves.

7.4.5.1 Where more than 275 sprinklers are required in a single fire area, the system shall be divided into sections of 275 sprinklers or fewer by means of check valves.

7.4.5.2 Where the system is installed in more than one fire area or story, not more than 600 sprinklers shall be supplied through any one check valve.

7.4.5.3 Each section shall have a 1¼ in. (32 mm) drain on the system side of each check valve supplemented by a dry pipe system auxiliary drain.

7.4.5.4 Section drain lines and dry pipe system auxiliary drains shall be located in heated areas or inside heated cabinets to enclose drain valves and auxiliary drains for each section.

7.4.5.5 Air exhaust valves at the end of a feed main and associated check valves shall be protected against freezing.

7.4.6 Time Limitation.

7.4.6.1 The sprinkler system shall be so constructed and the number of sprinklers controlled shall be so limited that water shall reach the farthest sprinkler within a period of time not exceeding 1 minute for each 400 ft (122 m) of common feed main from the time the heat-responsive system operates.

7.4.6.2 The maximum time permitted shall not exceed 3 minutes.

7.4.7 System Test Connection. The end section shall have a system test connection as required for dry pipe systems.

7.5 Multi-Cycle Systems.

7.5.1 All multi-cycle systems shall be specifically tested and listed as systems.

7.5.2 All multi-cycle systems shall be installed in compliance with the manufacturer's installation instructions.

7.6 Antifreeze Systems.

7.6.1* General.

7.6.1.1 The use of antifreeze solutions shall be in conformity with state and local health regulations.

7.6.1.2 Antifreeze shall not be used in ESFR systems unless at least one of the following two conditions is met:

- (1) For antifreeze solutions not referenced in this standard, the antifreeze solution shall be specifically listed for ESFR applications.
- (2) For antifreeze solutions referenced in this standard, the ESFR sprinkler shall be specifically listed for use with the antifreeze solution.

7.6.1.3 Where pendent sprinklers are utilized, the water shall be drained from the entire system after hydrostatic testing with water.

7.6.1.3.1 The requirements of 7.6.1.3 shall not apply where the system is hydrostatically tested with properly mixed antifreeze solution.

7.6.1.4 Where antifreeze systems are remote from the system riser, a placard shall be mounted on the system riser that indicates the number and location of all remote antifreeze systems supplied by that riser.

7.6.1.5 A placard shall be placed on the antifreeze system main valve that indicates the manufacture type and brand of the antifreeze solution, the concentration of the antifreeze solution used, and the volume of the antifreeze solution used in the system.

7.6.2* Antifreeze Solutions.

7.6.2.1 Where sprinkler systems are supplied by potable water connections, the use of antifreeze solutions other than water solutions of pure glycerine (C.P. or U.S.P. 96.5 percent grade) or propylene glycol shall not be permitted.

7.6.2.2 Glycerine-water and propylene glycol–water mixtures shown in Table 7.6.2.2 shall be considered suitable for use.

Table 7.6.2.2 Antifreeze Solutions to Be Used If Potable Water Is Connected to Sprinklers

Material	Solution (by volume)	Specific Gravity at 60°F (15.6°C)	Freezing Point	
			°F	°C
Glycerine	50% water	1.145	-20.9	-29.4
C.P. or U.S.P. grade*	40% water	1.171	-47.3	-44.1
	30% water	1.197	-22.2	-30.1
Hydrometer scale 1.000 to 1.200				
Propylene glycol	60% water	1.034	-6	-21.1
	50% water	1.041	-26	-32.2
	40% water	1.045	-60	-51.1
Hydrometer scale 1.000 to 1.200 (subdivisions 0.002)				

*C.P. — chemically pure; U.S.P. — United States Pharmacopoeia 96.5%.

7.6.2.3 If potable water is not connected to sprinklers, the commercially available materials indicated in Table 7.6.2.3 shall be permitted for use in antifreeze solutions.

Table 7.6.2.3 Antifreeze Solution to Be Used If Nonpotable Water Is Connected to Sprinklers

Material	Solution (by volume)	Specific Gravity at 60°F (15.6°C)	Freezing Point	
			°F	°C
Glycerine	See Table 7.6.2.2.			
Diethylene glycol	50% water	1.078	-13	-25.0
	45% water	1.081	-27	-32.8
	40% water	1.086	-42	-41.1
Hydrometer scale 1.000 to 1.120 (subdivisions 0.002)				
Ethylene glycol	61% water	1.056	-10	-23.3
	56% water	1.063	-20	-28.9
	51% water	1.069	-30	-34.4
	47% water	1.073	-40	-40.0
Hydrometer scale 1.000 to 1.120 (subdivisions 0.002)				
Propylene glycol	See Table 7.6.2.2.			

7.6.2.4* An antifreeze solution shall be prepared with a freezing point below the expected minimum temperature for the locality.

7.6.2.5 The specific gravity of the prepared solution shall be checked by a hydrometer, in accordance with Figure 7.6.2.5(a), Figure 7.6.2.5(b), and Figure 7.6.2.5(c), with suitable scale or a refractometer having a scale calibrated for the antifreeze solution involved.

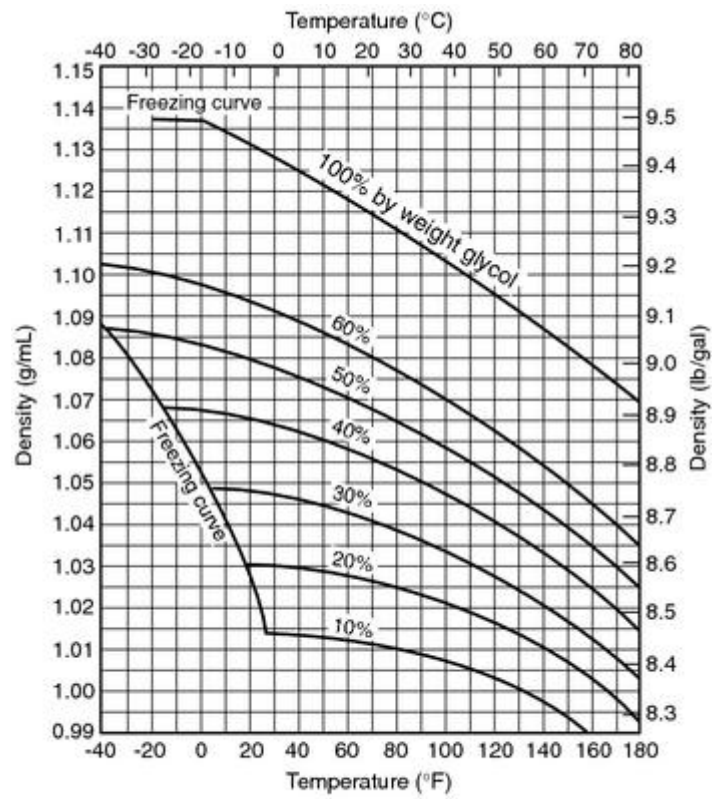

Note: The 100 percent concentration curves are provided for information only so that densities are known for calculating solutions.

FIGURE 7.6.2.5(a) Densities of Aqueous Ethylene Glycol Solutions (Percent by Weight).

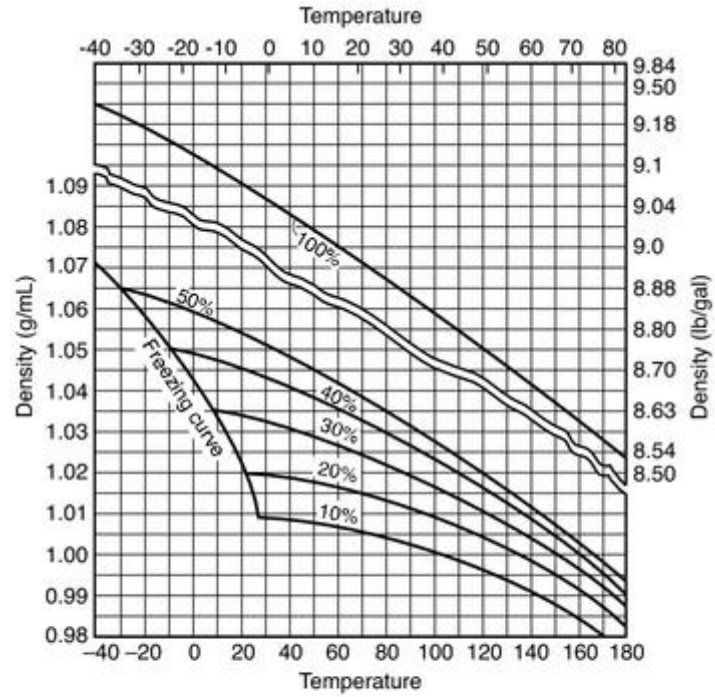

Note: The 100 percent concentration curves are provided for information only so that densities are known for calculating solutions.

FIGURE 7.6.2.5(b) Densities of Aqueous Propylene Glycol Solutions (Percent by Weight).

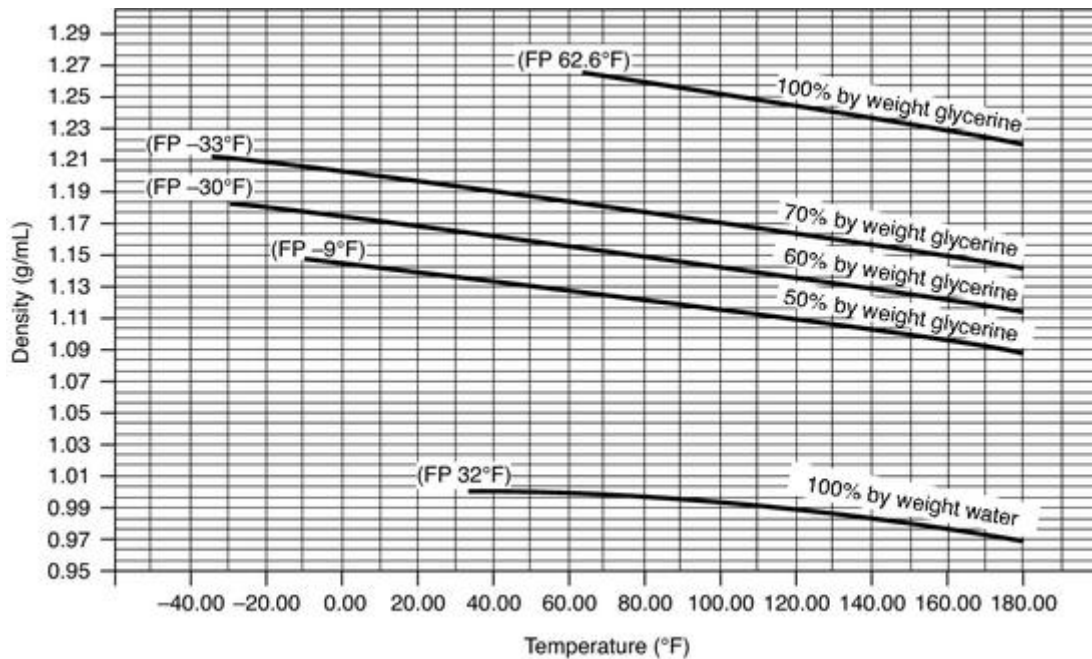

Note: The 100 percent concentration curves are provided for information only so that densities are known for calculating solutions.

Data Sources:

1. Density data for 100 percent water was taken from Lange's *Handbook of Chemistry*, Revised Tenth Edition, page 1199. Temperatures have been converted from Celsius to Fahrenheit units, and data points at 10 degree Fahrenheit multiples have been determined by linear interpolation. Conversion from relative to absolute density was achieved by multiplying by 0.999973.
2. Densities of glycerine-water solutions at 0°C and above were taken from Table III (p. 6) in *Glycerol* by Anthony Armin Newman, C.R.C. Press, 1968. Densities for temperatures below 0°C were taken from Table IV. Temperatures have been converted from Celsius to Fahrenheit units, and data points at 10 degree Fahrenheit multiples have been determined by linear interpolation.
3. Density data for pure glycerine was taken from Table II (p. 6) in *Glycerol* by Anthony Armin Newman, C.R.C. Press, 1968, and derived from the thermal expansion data in Table 7-9 in *Glycerol* by Carl S. Miner and N.N. Dalton, Reinhold Publishing Corp., 1953 (American Chemical Society Monograph Series #117) using the density for 0°C as a base point. Temperatures have been converted from Celsius to Fahrenheit units, and data points at 10 degree Fahrenheit multiples have been determined by linear interpolation.
4. Freezing points were taken from the article, "Freezing Points of Glycerol and Its Aqueous Solution" by Leonard B. Lane in *Industrial and Engineering Chemistry*, volume 17 (1925), number 9, page 924. Temperatures have been converted from Celsius to Fahrenheit units.

FIGURE 7.6.2.5(c) Densities of Aqueous Glycerine Solutions (Percent by Weight).

7.6.2.6 The concentration of antifreeze solutions shall be limited to the minimum necessary for the anticipated minimum temperature.

7.6.3 Arrangement of Supply Piping and Valves.

7.6.3.1* Where the connection between the antifreeze system and the wet pipe system does not incorporate a backflow prevention device, and the conditions of 7.6.3.4 are not met, piping and valves shall be installed as illustrated in Figure 7.6.3.1.

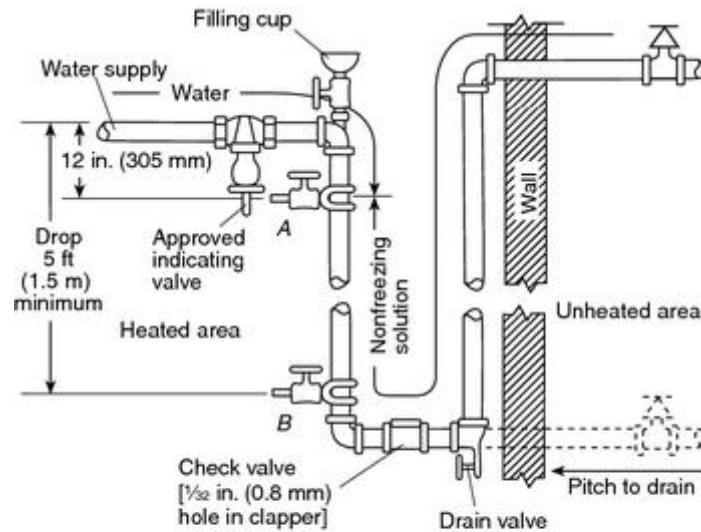

Notes:

1. Check valve shall be permitted to be omitted where sprinklers are below the level of valve A.
2. The 1/2 in. (0.8 mm) hole in the check valve clapper is needed to allow for expansion of the solution during a temperature rise, thus preventing damage to sprinklers.

FIGURE 7.6.3.1 Arrangement of Supply Piping and Valves.

7.6.3.2* Where the connection between the antifreeze system and the wet pipe system incorporates a backflow prevention device, and the conditions of 7.6.3.4 are not met, piping and valves shall be installed as illustrated in Figure 7.6.3.2.

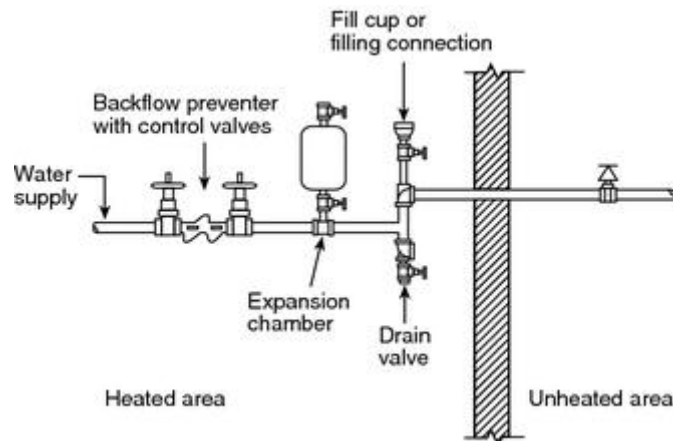

FIGURE 7.6.3.2 Arrangement of Supply Piping with Backflow Device.

7.6.3.3 Where the connection between the antifreeze solution and the wet pipe system incorporates a backflow prevention device, and the conditions of 7.6.3.4 are not met, a listed expansion chamber of appropriate size and precharged air pressure shall be provided to compensate for thermal expansion of the antifreeze solution as illustrated in Figure 7.6.3.2.

7.6.3.4 The requirements of paragraphs 7.6.3.1, 7.6.3.2, and 7.6.3.3 shall not apply where the following three conditions are met:

- (1) The antifreeze system is provided with an automatic pressure pump or other device or apparatus to automatically maintain a higher pressure on the system side than on the supply side of the water supply check valve separating the antifreeze system from the water supply.
- (2) Provision is made to automatically release solution to prevent overpressurization due to thermal expansion of the solution.
- (3) Provision is made to automatically supply premixed solution as needed to restore system pressure due to thermal contraction.

7.6.3.5* Systems larger than 40 gal (151 L) shall have a drain/test connection installed at the most remote portion of the system.

7.7 Automatic Sprinkler Systems with Non-Fire Protection Connections.

7.7.1 Circulating Closed-Loop Systems.

7.7.1.1 System Components.

7.7.1.1.1 A circulating closed-loop system is primarily a sprinkler system and shall comply with all provisions of this standard such as those for control valves, area limitations of a system, alarms, fire department connections, sprinkler spacing, and so forth, except as modified by Section 7.7.

7.7.1.1.2 Piping, fittings, valves, and pipe hangers shall meet the requirements specified in Chapter 6.

7.7.1.1.3 Unless the requirements of 7.7.1.1.4 are met, a dielectric fitting shall be installed in the junction where dissimilar piping materials are joined (e.g., copper to steel).

7.7.1.1.4 Dielectric fittings shall not be required in the junction where sprinklers are connected to piping.

7.7.1.1.5 Other auxiliary devices shall not be required to be listed for sprinkler service; however, these devices, such as pumps, circulating pumps, heat exchangers, radiators, and luminaires, shall be pressure rated at 175 psi or 300 psi (12.1 bar or 20.7 bar) (rupture pressure of five times rated water system working pressure) to match the required rating of sprinkler system components.

7.7.1.1.6 Auxiliary devices shall incorporate materials of construction and be so constructed that they will maintain their physical integrity under fire conditions to avoid impairment to the fire protection system.

7.7.1.1.7 Auxiliary devices, where hung from the building structure, shall be supported independently from the sprinkler portion of the system, following recognized engineering practices.

7.7.1.2* Hydraulic Characteristics. Piping systems for attached heating and cooling equipment shall have auxiliary pumps or an arrangement made to return water to the piping system in order to ensure the following:

- (1) Water for sprinklers shall not be required to pass through heating or cooling equipment.
- (2) At least one direct path shall exist for waterflow from the sprinkler water supply to every sprinkler.
- (3) Pipe sizing in the direct path shall be in accordance with the design requirements of this standard.
- (4) No portions of the sprinkler piping shall have less than the sprinkler system design pressure, regardless of the mode of operation of the attached heating or cooling equipment.
- (5) There shall be no loss or outflow of water from the system due to or resulting from the operation of heating or cooling equipment.
- (6) Shutoff valves and a means of drainage shall be provided on piping to heating or cooling equipment at all points of connection to sprinkler piping and shall be installed in such a manner as to make possible repair or removal of any auxiliary component without impairing the serviceability and response to the sprinkler system.
- (7) All auxiliary components, including the strainer, shall be installed on the auxiliary equipment side of the shutoff valves.

7.7.1.3 Water Temperature.

7.7.1.3.1 Maximum.

7.7.1.3.1.1 In no case shall maximum water temperature flowing through the sprinkler portion of the system exceed 120°F (49°C).

7.7.1.3.1.2 Protective control devices listed for this purpose shall be installed to shut down heating or cooling systems when the temperature of water flowing through the sprinkler portion of the system exceeds 120°F (49°C).

7.7.1.3.1.3 Where the water temperature exceeds 100°F (37.8°C), intermediate or higher temperature-rated sprinklers shall be used.

7.7.1.3.2 Minimum. Precautions shall be taken to ensure that temperatures below 40°F (4°C) are not permitted.

7.7.1.4 Obstruction to Discharge. Automatic sprinklers shall not be obstructed by auxiliary devices, piping, insulation, and so forth, from detecting fire or from proper distribution of water.

7.7.1.5 Signs. Caution signs shall be attached to all valves controlling sprinklers. The caution sign shall be worded as follows:

This valve controls fire protection equipment.
Do not close until after fire has been extinguished.
Use auxiliary valves when necessary
to shut off supply to auxiliary equipment.

CAUTION: Automatic alarm will be sounded if this valve is closed.

7.7.1.6 Water Additives.

7.7.1.6.1 Materials added to water shall not adversely affect the fire-fighting properties of the water and shall be in conformity with any state or local health regulations.

7.7.1.6.2 Due care and caution shall be given to the use of additives that can remove or suspend scale from older piping systems.

7.7.1.6.3 Where additives are necessary for proper system operation, due care shall be taken to ensure that additives are replenished after alarm testing or whenever water is removed from the system.

7.7.1.7 Waterflow Detection.

7.7.1.7.1 The supply of water from sprinkler piping through auxiliary devices, circulatory piping, and pumps shall not under any condition or operation, transient or static, cause false sprinkler waterflow signals.

7.7.1.7.2 A sprinkler waterflow signal shall not be impaired when water is discharged through an opened sprinkler or through the system test connection while auxiliary equipment is in any mode of operation (on, off, transient, stable).

7.8 Outside Sprinklers for Protection Against Exposure Fires (Exposure Protection Sprinkler Systems).

7.8.1 Applications.

7.8.1.1 Exposure protection sprinkler systems shall be permitted on buildings and structures regardless of whether the building's interior is protected by a sprinkler system.

7.8.1.2 Exposure protection systems shall be installed to provide protection of windows and other openings within masonry walls, complete protection of walls, or protection of roofs.

7.8.2 Water Supply and Control.

7.8.2.1 Unless the requirements of 7.8.2.2 are met, sprinklers installed for protection against exposure fires shall be supplied from a standard water supply as outlined in Chapter 23.

7.8.2.2 Where approved, other supplies, such as manual valves or pumps or fire department connections, shall be permitted to supply water to sprinklers for exposure protection.

7.8.2.3 Where fire department connections are used for water supply, they shall be so located that they will not be affected by the exposing fire.

7.8.3 Control.

7.8.3.1 Each system of outside sprinklers shall have an independent control valve.

7.8.3.2 Manually controlled open sprinklers shall be used only where constant supervision is present.

7.8.3.3 Sprinklers shall be of the open or automatic type. Automatic sprinklers in areas

subject to freezing shall be on dry pipe systems conforming to Section 7.2 or antifreeze systems conforming to Section 7.6.

7.8.3.4 Automatic systems of open sprinklers shall be controlled by the operation of fire detection devices designed for the specific application.

7.8.4 System Components.

7.8.4.1 Drain Valves. Each system of outside sprinklers shall have a separate drain valve installed on the system side of each control valve, except where an open sprinkler, top-fed system is arranged to facilitate drainage.

7.8.4.2 Check Valves.

7.8.4.2.1 Where sprinklers are installed on two adjacent sides of a building, protecting against two separate and distinct exposures, with separate control valves for each side, the end lines shall be connected with check valves located so that one sprinkler around the corner will operate [see Figure 7.8.4.2.1(a) and Figure 7.8.4.2.1(b)].

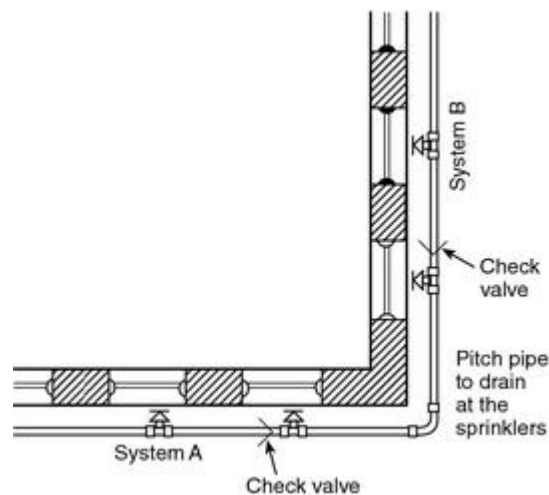

FIGURE 7.8.4.2.1(a) Typical Arrangement of Check Valves.

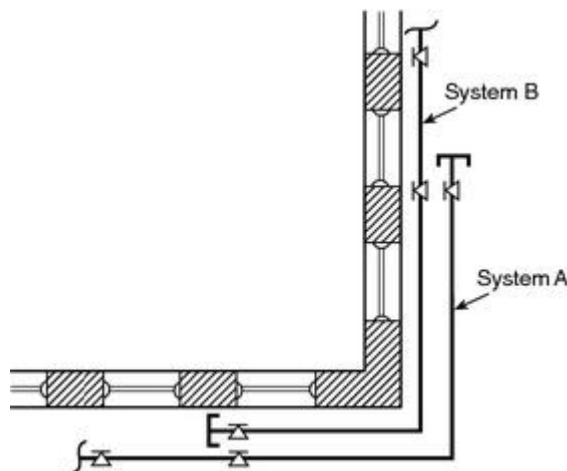

FIGURE 7.8.4.2.1(b) Alternate Arrangement of Check Valves.

7.8.4.2.2 The intermediate pipe between the two check valves shall be arranged to drain.

7.8.4.2.3 As an alternate solution, an additional sprinkler shall be installed on each system located around the corner from the system involved.

7.8.4.3 System Arrangement. Where one exposure affects two sides of the protected structure, the system shall not be subdivided between the two sides but rather shall be arranged to operate as a single system.

7.8.5 Pipe and Fittings. Pipe and fittings installed on the exterior of the building or structure shall be corrosion resistant.

7.8.6 Strainers. A listed strainer shall be provided in the riser or feed main that supplies sprinklers having nominal K-factors smaller than K-2.8 (40).

7.8.7 Gauge Connections. A listed pressure gauge conforming with 8.17.3 shall be installed immediately below the control valve of each system.

7.8.8 Sprinklers.

7.8.8.1 A single line of sprinklers is permitted to protect a maximum of two stories of wall area or two levels of vertically aligned windows where architectural features are sufficiently flush to allow rundown.

7.8.8.2 Where window sills or similar features result in recesses or projections exceeding 1 in. (25.4 mm) in depth, separate sprinklers shall be provided for each window on each level, regardless of whether protection is being provided for windows or complete walls.

7.8.8.3 For wall protection systems, sprinklers shall be located 6 in. to 12 in. (152 mm to 305 mm) from the wall surface and within 6 in. (152 mm) of the top of the wall, with maximum spacing of 8 ft (2.44 m) or as indicated in the sprinkler listing for exposure protection use.

7.8.8.4 For protection of window and similar openings, listed window sprinklers shall be positioned within 2 in. (50.8 mm) of the top of the window sash in accordance with Table 7.8.8.4.

Table 7.8.8.4 Position of Window Sprinklers

Width of Window	Nominal K-factor		Nominal Distance from Window
	U.S.	Metric	
Up to 3 ft	2.8	40	7 in.
>3 to 4 ft	2.8	40	8 in.
>4 to 5 ft	2.8	40	9 in.
	5.6	80	12 in.
>5 to 7 ft	11.2	161	12 in.
	Two 2.8	40	7 in.
>7 to 9.5 ft	14.0	202	12 in.
	Two 2.8	40	9 in.

Table 7.8.8.4 Position of Window Sprinklers

Width of Window	Nominal K-factor		Nominal Distance from Window
	U.S.	Metric	
>9.5 to 12 ft	Two 5.6	80	12 in.

For SI units, 1 ft = 0.3048 m.

7.8.8.5 Where exposure protection sprinkler systems are installed, listed cornice sprinklers shall be used to protect combustible cornices exceeding 12 in. (305 mm) in depth. Cornice sprinklers shall be installed in each bay formed by cornice features and shall be spaced up to a maximum distance of 10 ft (3.05 m) apart, with deflectors 8 in. (203 mm) below the underside of the roof sheathing.

7.8.8.6 Open spray sprinklers (upright, pendent, or sidewall) shall be permitted for application in roof protection when installed in accordance with ordinary hazard Group 1 protection areas and discharge criteria, with deflectors aligned parallel to the slope and positioned a minimum 18 in. (457 mm) above the roof surface. Upright sprinklers positioned as ridge pole sprinklers shall be permitted with their deflectors horizontal and minimum 6 in. (152 mm) above the ridge, with their maximum spacing and protection areas determined in the plan view rather than along the slope.

7.9* Refrigerated Spaces.

7.9.1 Spaces Maintained at Temperatures Above 32°F (0°C). Where temperatures are maintained above 32°F (0°C) in refrigerated spaces, the requirements in this section shall not apply.

7.9.2* Spaces Maintained at Temperatures Below 32°F (0°C).

7.9.2.1 General.

7.9.2.1.1 Where sprinkler pipe passes through a wall or floor into the refrigerated space, a section of pipe arranged for removal shall be provided immediately inside the space.

7.9.2.1.2 The removable length of pipe required in 7.9.2.1.1 shall be a minimum of 30 in. (762 mm).

7.9.2.2 Low Air Pressure Alarm.

7.9.2.2.1 Unless the requirements of 7.9.2.2.2 are met, a low air pressure alarm to a constantly attended location shall be installed.

7.9.2.2.2 Systems equipped with local low pressure alarms and an automatic air maintenance device shall not be required to alarm to a constantly attended location.

7.9.2.3 Piping Pitch. Piping in refrigerated spaces shall be installed with pitch as outlined in 8.16.2.3.

7.9.2.4* Air or Nitrogen Supply. Air or nitrogen supply for systems shall be one of the following:

- (1) Air from the room of lowest temperature to reduce the moisture content
- (2) Air compressor/dryer package listed for the application utilizing ambient air
- (3) Compressed nitrogen gas from cylinders used in lieu of compressed air

7.9.2.5* Control Valve. An indicating-type control valve for operational testing of the system shall be provided on each sprinkler riser outside of the refrigerated space.

7.9.2.6* Check Valve.

7.9.2.6.1 Unless the requirements of 7.9.2.6.2 are met, a check valve with a $\frac{3}{32}$ in. (2.4 mm) diameter hole in the clapper shall be installed in the system riser below the test valve required in 7.9.2.5.

7.9.2.6.2 Check valves shall not be required where dry pipe or preaction valves are used and designed to completely drain all water above the seat and that are listed for installation without priming water remaining and where priming water is not used in the system riser.

7.9.2.7* Air or Nitrogen Supply Piping.

7.9.2.7.1 The air or nitrogen supply piping entering the freezer area shall be as stated in 7.9.2.7.1.1 and 7.9.2.7.1.2.

7.9.2.7.1.1 Air Supply. The supply piping shall be equipped with two easily removable supply lines at least 6 ft (1.9 m) long and at least 1 in. (25 mm) in diameter as shown in Figure 7.9.2.7.1.1(a) or Figure 7.9.2.7.1.1(b).

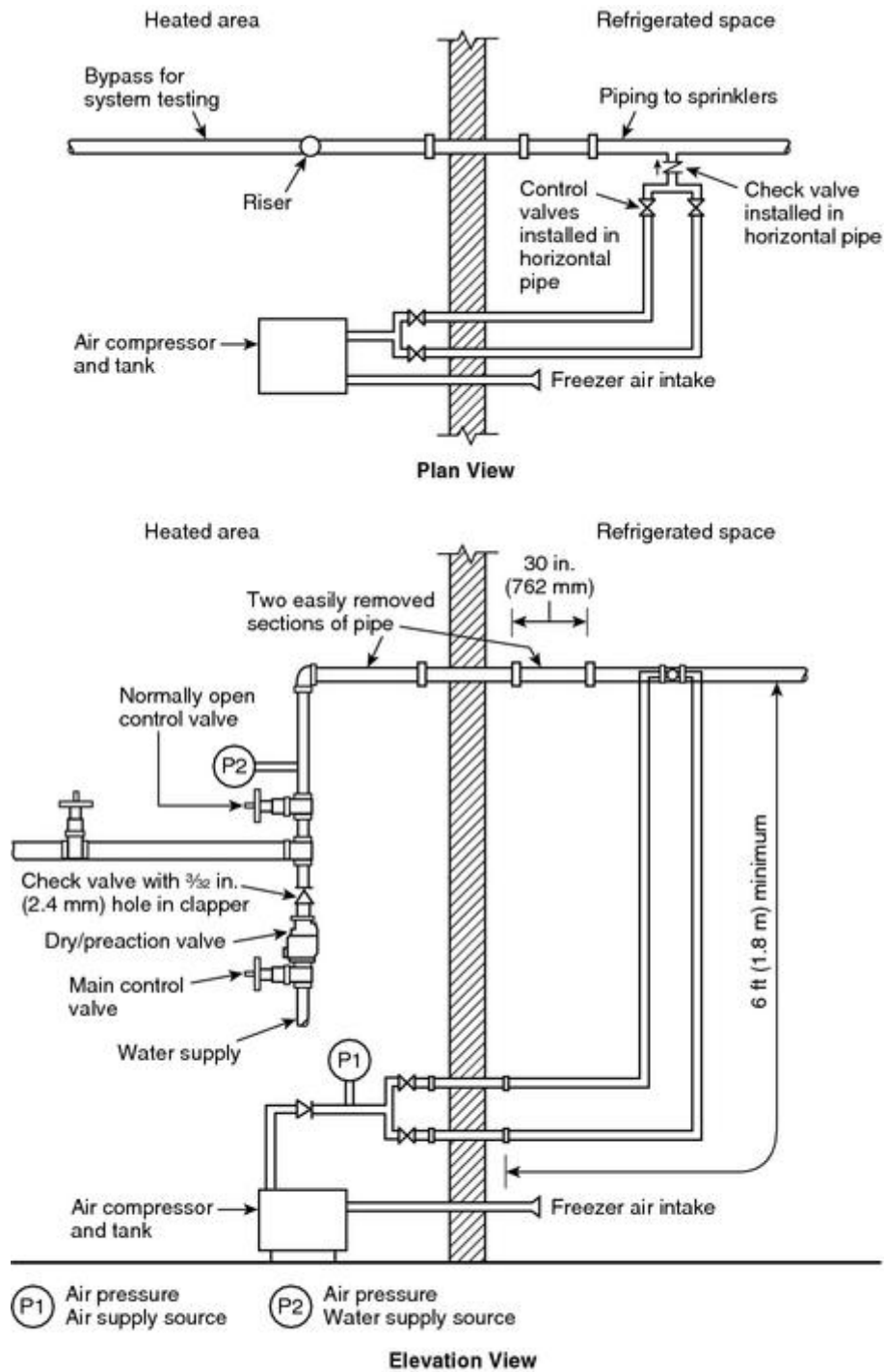

- Notes:
1. Check valve with 3/32 in. (2.4 mm) hole in clapper not required if prime water not used.
 2. Supply air to be connected to top or side of system pipe.
 3. Each removable air line to be a minimum of 1 in. (25 mm) diameter and a minimum of 6 ft (1.8 m) long.

FIGURE 7.9.2.7.1.1(a) Refrigerator Area Sprinkler System Used to Minimize the Chances of Developing Ice Plugs.

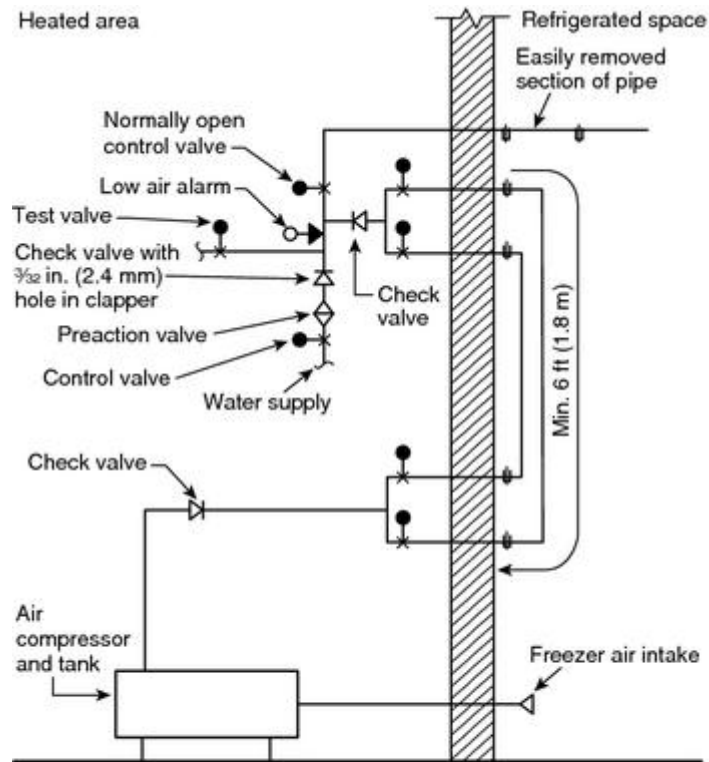

- Notes:
1. Check valve with $\frac{3}{32}$ in. (2.4 mm) hole in clapper not required if prime water not used.
 2. Each removable air line shall be installed a minimum of 1 in. (25 mm) in diameter and a minimum of 6 ft (1.8 m) long.

FIGURE 7.9.2.7.1.1(b) Preaction System Arrangement.

7.9.2.7.1.2 Nitrogen Supply. The supply piping shall be equipped with a single easily removable supply line at least 6 ft (1.9 m) long and at least 1 in. (25 mm) in diameter.

7.9.2.7.2 Each supply line shall be equipped with control valves located in the warm area.

7.9.2.7.3 Only one air supply line shall be open to supply the system air at any one time.

7.9.2.8 Fire Detection for Preaction Release.

7.9.2.8.1 Detectors for Preaction Systems.

7.9.2.8.1.1* The release system shall be designed to operate prior to sprinkler operation, unless detectors meet the requirements of 7.9.2.8.1.2. Detectors shall be electric or pneumatic fixed temperature type with temperature ratings less than that of the sprinklers. Detection devices shall not be rate-of-rise type.

7.9.2.8.1.2 Where the system is a double interlock preaction system or single interlock preaction antifreeze system, detection devices shall be permitted to be any type specifically approved for use in a refrigerated area if installed in accordance with their listing requirements and *NFPA 72, National Fire Alarm Code*.

7.9.2.8.2 Detector Location at Ceiling. Under smooth ceilings, detectors shall be spaced not exceeding their listed spacing. For other than smooth ceilings, detectors shall not exceed

one-half of the listed linear detector spacing or full allowable sprinkler spacing, whichever is greater.

7.9.2.8.3 Detector Location in Racks. Unless conditions in 7.9.2.8.4 are met, one level of detectors shall be installed for each level of sprinklers. Detectors shall be installed vertically within one storage level of the rack sprinklers and as follows:

- (1) Detectors shall be located in the transverse flue in single-row racks and in the longitudinal flue in double-row racks.
- (2) For multiple row racks, detectors shall be located in either longitudinal or transverse flue space and shall be within 5 ft (1.5 m) horizontally of each sprinkler.
- (3) Separate detection systems shall be installed for ceiling sprinkler systems and in-rack sprinkler systems.
- (4) Where system is double interlock preaction type, ceiling detection system shall operate solenoid valves on both ceiling and in-rack preaction systems.

7.9.2.8.4 Single Detection System for Ceiling and In-Rack Sprinklers. Ceiling detection only shall be permitted where all of the following conditions are met:

- (1) Maximum storage height is 35 ft (10.7 m).
- (2) Maximum ceiling height is 40 ft (12.2 m).
- (3) Maximum hazard of storage is Class III.
- (4) No solid shelves are present.
- (5) One preaction valve is used for both ceiling and in-rack sprinklers protecting the same area, with separate indicating control valves and check valves provided downstream as shown in Figure 7.9.2.8.4.
- (6) Detectors at the ceiling are spaced at a maximum of one-half the listed detector spacing but not less than the sprinkler spacing.

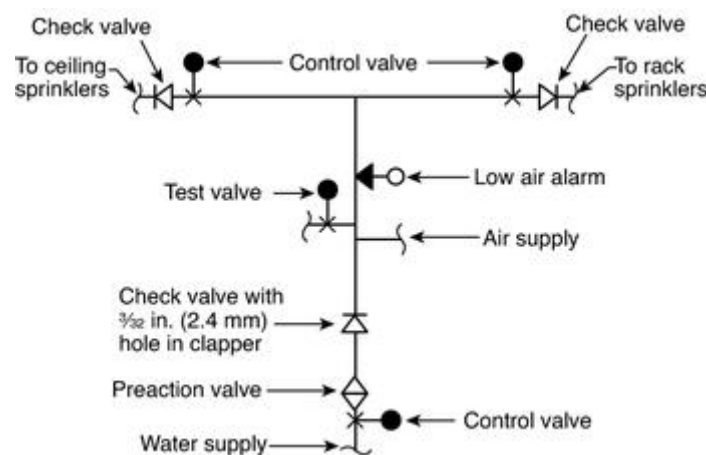

FIGURE 7.9.2.8.4 Valve Arrangement.

7.10 Commercial-Type Cooking Equipment and Ventilation.

7.10.1 General. In cooking areas protected by automatic sprinklers, additional sprinklers or automatic spray nozzles shall be provided to protect commercial-type cooking equipment and ventilation systems that are designed to carry away grease-laden vapors unless otherwise protected.

7.10.2* Sprinklers and Automatic Spray Nozzles.

7.10.2.1 Unless the requirements of 7.10.2.2 are met, standard sprinklers or automatic spray nozzles shall be so located as to provide for the protection of exhaust ducts, hood exhaust duct collars, and hood exhaust plenum chambers.

7.10.2.2 Sprinklers or automatic spray nozzles in ducts, duct collars, and plenum chambers shall not be required where all cooking equipment is served by listed grease extractors.

7.10.2.3 Unless the requirements of 7.10.2.5 are met, standard sprinklers or automatic spray nozzles shall be so located as to provide for the protection of cooking equipment and cooking surfaces.

7.10.2.4 Hoods containing automatic fire-extinguishing systems are protected areas; therefore, these hoods are not considered obstructions to overhead sprinkler systems and shall not require floor coverage underneath.

7.10.2.5 Cooking equipment below hoods that contain automatic fire-extinguishing equipment is protected and shall not require protection from the overhead sprinkler system.

7.10.3 Sprinkler and Automatic Spray Nozzle Location — Ducts.

7.10.3.1 Unless the requirements of 7.10.3.2 or 7.10.3.4 are met, exhaust ducts shall have one sprinkler or automatic spray nozzle located at the top of each vertical riser and at the midpoint of each offset.

7.10.3.2 Sprinklers or automatic spray nozzles shall not be required in a vertical riser located outside of a building, provided the riser does not expose combustible material or provided the interior of the building and the horizontal distance between the hood outlet and the vertical riser is at least 25 ft (7.6 m).

7.10.3.3 Unless the requirements of 7.10.3.4 are met, horizontal exhaust ducts shall have sprinklers or automatic spray nozzle devices located on 10 ft (3 m) centers beginning no more than 5 ft (1.5 m) from the duct entrance.

7.10.3.4 Sprinklers or automatic spray nozzles shall be required in ducts.

7.10.3.4.1 Where ducts do not exceed 75 ft (22.86 m) in length and the entire exhaust duct is protected in accordance with UL 300, *Standard for Safety Fire Testing of Fire Extinguishing Systems for Protection of Restaurant Cooking Areas*, sprinkler(s) [or automatic spray nozzle(s)] shall not be required.

7.10.3.5 A sprinkler(s) or an automatic spray nozzle(s) in exhaust ducts subject to freezing shall be properly protected against freezing by approved means. (*See 8.16.4.1.*)

7.10.4 Sprinkler and Automatic Spray Nozzle Location — Duct Collar.

7.10.4.1 Each hood exhaust duct collar shall have one sprinkler or automatic spray nozzle located 1 in. minimum to 12 in. maximum (25 mm minimum to 305 mm maximum) above the point of duct collar connection in the hood plenum.

7.10.4.2 Hoods that have listed fire dampers located in the duct collar shall be protected with a sprinkler or automatic spray nozzle located on the discharge side of the damper and shall be so positioned as not to interfere with damper operation.

7.10.5 Sprinkler and Automatic Spray Nozzle Location — Exhaust Plenum Chambers.

7.10.5.1 Hood exhaust plenum chambers shall have one sprinkler or automatic spray nozzle centered in each chamber not exceeding 10 ft (3 m) in length.

7.10.5.2 Plenum chambers greater than 10 ft (3 m) in length shall have two sprinklers or automatic spray nozzles evenly spaced, with the maximum distance between the two sprinklers not to exceed 10 ft (3 m).

7.10.6 Sprinkler and Automatic Spray Nozzle Temperature Ratings and Orifice Sizes.

7.10.6.1 Where the exposed temperature is expected to be 300°F (149°C) or less, sprinklers, or automatic spray nozzles being used in duct, duct collar, and plenum areas shall be of the extra high-temperature classification [325°F to 375°F (163°C to 191°C)].

7.10.6.2 When use of a temperature-measuring device indicates temperatures above 300°F (149°C), a sprinkler or automatic spray nozzle of higher classification shall be used.

7.10.6.3 Sprinklers or automatic spray nozzles being used in duct, duct collar, and plenum areas shall have orifice with K-factors not less than 1.4 and not more than 5.6.

7.10.7 Sprinkler and Automatic Spray Nozzle. Access shall be provided to all sprinklers or automatic spray nozzles for examination and replacement.

7.10.8 Cooking Equipment.

7.10.8.1 General. Cooking equipment (such as deep fat fryers, ranges, griddles, and broilers) that is considered to be a source of ignition shall be protected in accordance with the provisions of 7.10.1.

7.10.8.2 Deep Fat Fryers.

7.10.8.2.1 A sprinkler or automatic spray nozzle used for protection of deep fat fryers shall be listed for that application.

7.10.8.2.2 The position, arrangement, location, and water supply for each sprinkler or automatic spray nozzle shall be in accordance with its listing.

7.10.8.3 Fuel and Heat Shutoff.

7.10.8.3.1 The operation of any cooking equipment sprinkler or automatic spray nozzle shall automatically shut off all sources of fuel and heat to all equipment requiring protection.

7.10.8.3.2 Any gas appliance not requiring protection but located under ventilating

equipment shall also be shut off.

7.10.8.3.3 All shutdown devices shall be of the type that requires manual resetting prior to fuel or power being restored.

7.10.9 Indicating Valves. A listed indicating valve shall be installed in the water supply line to the sprinklers and spray nozzles protecting the cooking and ventilating system.

7.10.10 Strainers. A listed line strainer shall be installed in the main water supply preceding sprinklers or automatic spray nozzles having nominal K-factors smaller than K-2.8 (40).

7.10.11 Test Connection. A system test connection shall be provided to verify proper operation of equipment specified in 7.10.8.3.

7.10.12 Sprinkler and Automatic Spray Nozzle Replacement.

7.10.12.1 Unless the requirements of 7.10.12.2 are met, sprinklers and automatic spray nozzles used for protecting commercial-type cooking equipment and ventilating systems shall be replaced annually.

7.10.12.2 Where automatic bulb-type sprinklers or spray nozzles are used and annual examination shows no buildup of grease or other material on the sprinklers or spray nozzles, such sprinklers or spray nozzles shall be permitted to be continued in use.

Chapter 8 Installation Requirements

8.1* Basic Requirements.

8.1.1* The requirements for spacing, location, and position of sprinklers shall be based on the following principles:

- (1) Sprinklers shall be installed throughout the premises.
- (2) Sprinklers shall be located so as not to exceed the maximum protection area per sprinkler.
- (3) Sprinklers shall be positioned and located so as to provide satisfactory performance with respect to activation time and distribution.
- (4) Sprinklers shall be permitted to be omitted from areas specifically allowed by this standard.
- (5) When sprinklers are specifically tested and test results demonstrate that deviations from clearance requirements to structural members do not impair the ability of the sprinkler to control or suppress a fire, their positioning and locating in accordance with the test results shall be permitted.
- (6) Clearance between sprinklers and ceilings exceeding the maximums specified in this standard shall be permitted, provided that tests or calculations demonstrate comparable sensitivity and performance of the sprinklers to those installed in conformance with these sections.

- (7) Furniture, such as portable wardrobe units, cabinets, trophy cases, and similar features not intended for occupancy, does not require sprinklers to be installed in them. This type of feature shall be permitted to be attached to the finished structure.

8.1.2* System valves and gauges shall be accessible for operation, inspection, tests, and maintenance.

8.2 System Protection Area Limitations.

8.2.1 The maximum floor area on any one floor to be protected by sprinklers supplied by any one sprinkler system riser or combined system riser shall be as follows:

- (1) Light hazard — 52,000 ft² (4831 m²)
- (2) Ordinary hazard — 52,000 ft² (4831 m²)
- (3) Extra hazard
 - (a) Pipe schedule — 25,000 ft² (2323 m²)
 - (b) Hydraulically calculated — 40,000 ft² (3716 m²)
- (4) Storage — High-piled storage (as defined in 3.9.1.13) and storage covered by other NFPA standards — 40,000 ft² (3716 m²)

8.2.2 The floor area occupied by mezzanines shall not be included in the area limits of 8.2.1.

8.2.3 Where single systems protect extra hazard, high-piled storage, or storage covered by other NFPA standards, and ordinary or light hazard areas, the extra hazard or storage area coverage shall not exceed the floor area specified for that hazard and the total area coverage shall not exceed 52,000 ft² (4831 m²).

8.2.4 Multiple buildings attached by canopies, covered breezeways, common roofs, or a common wall(s) shall be permitted to be supplied by a single fire sprinkler riser. The maximum system size shall comply with 8.2.1.

8.2.5* Detached Buildings.

8.2.5.1 Unless the requirements of 8.2.5.2 apply, detached buildings, regardless of separation distance, that do not meet the criteria of 8.2.4 shall be provided with separate fire sprinkler systems.

8.2.5.2 When acceptable to the authority having jurisdiction, detached structures shall be permitted to be supplied by the fire sprinkler system of an adjacent building. (*See A.8.2.5 for guidance.*)

8.3 Use of Sprinklers.

8.3.1 General.

8.3.1.1* Sprinklers shall be installed in accordance with their listing.

8.3.1.2 The requirements of 8.3.1.1 shall not apply where construction features or other special situations require unusual water distribution, and listed sprinklers shall be permitted

to be installed in positions other than anticipated by their listing to achieve specific results.

8.3.1.3* Upright sprinklers shall be installed with the frame arms parallel to the branch line, unless specifically listed for other orientation.

8.3.1.4 Where solvent cement is used as the pipe and fittings bonding agent, sprinklers shall not be installed in the fittings prior to the fittings being cemented in place.

8.3.1.5 Protective Caps and Straps.

8.3.1.5.1* Protective caps and straps shall be removed using means that are in accordance with the manufacturer's installation instructions.

8.3.1.5.2* Protective caps and straps shall be removed from all sprinklers prior to the time when the sprinkler system is placed in service.

8.3.1.5.3 Protective caps and straps on all upright sprinklers or on any sprinklers installed more than 10 ft (3 m) above the floor shall be permitted to be removed from sprinklers immediately following their installation.

8.3.2 Temperature Ratings.

8.3.2.1* Unless the requirements of 8.3.2.2, 8.3.2.3, 8.3.2.4, or 8.3.2.5 are met, ordinary temperature-rated sprinklers shall be used throughout buildings.

8.3.2.2 Where maximum ceiling temperatures exceed 100°F (38°C), sprinklers with temperature ratings in accordance with the maximum ceiling temperatures of Table 6.2.5.1 shall be used.

8.3.2.3 Intermediate- and high-temperature sprinklers shall be permitted to be used throughout ordinary and extra hazard occupancies and as allowed in this standard and other NFPA codes and standards.

8.3.2.4 Sprinklers of intermediate- and high-temperature classifications shall be installed in specific locations as required by 8.3.2.5.

8.3.2.5 The following practices shall be observed to provide sprinklers of other than ordinary-temperature classification unless other temperatures are determined or unless high-temperature sprinklers are used throughout, and temperature selection shall be in accordance with Table 8.3.2.5(a), Table 8.3.2.5(b), and Figure 8.3.2.5:

- (1) Sprinklers in the high-temperature zone shall be of the high-temperature classification, and sprinklers in the intermediate-temperature zone shall be of the intermediate-temperature classification.
- (2) Sprinklers located within 12 in. (305 mm) to one side or 30 in. (762 mm) above an uncovered steam main, heating coil, or radiator shall be of the intermediate-temperature classification.
- (3) Sprinklers within 7 ft (2.1 m) of a low-pressure blowoff valve that discharges free in a large room shall be of the high-temperature classification.
- (4) Sprinklers under glass or plastic skylights exposed to the direct rays of the sun shall

be of the intermediate-temperature classification.

- (5) Sprinklers in an unventilated, concealed space, under an uninsulated roof, or in an unventilated attic shall be of the intermediate-temperature classification.
- (6) Sprinklers in unventilated show windows having high-powered electric lights near the ceiling shall be of the intermediate-temperature classification.
- (7) Sprinklers protecting commercial-type cooking equipment and ventilation systems shall be of the high- or extra high-temperature classification as determined by use of a temperature-measuring device. (See 7.10.6.)
- (8) Sprinklers protecting residential areas installed near specific heat sources identified in Table 8.3.2.5(c) shall be installed in accordance with Table 8.3.2.5(c).
- (9) Sprinklers in walk-in type coolers and freezers with automatic defrosting shall be of the intermediate-temperature classification or higher.

Table 8.3.2.5(a) Temperature Ratings of Sprinklers Based on Distance from Heat

Type of Heat Condition	Ordinary Degree Rating	Intermediate Degree Rating	High I
(1) Heating ducts			
(a) Above	More than 2 ft 6 in.	2 ft 6 in. or less	
(b) Side and below	More than 1 ft 0 in.	1 ft 0 in. or less	
(c) Diffuser	Any distance except as shown under Intermediate Degree Rating column	<i>Downward discharge:</i> Cylinder with 1 ft 0 in. radius from edge extending 1 ft 0 in. below and 2 ft 6 in. above <i>Horizontal discharge:</i> Semicylinder with 2 ft 6 in. radius in direction of flow extending 1 ft 0 in. below and 2 ft 6 in. above	
(2) Unit heater			
(a) Horizontal discharge		<i>Discharge side:</i> 7 ft 0 in. to 20 ft 0 in. radius pie-shaped cylinder (see Figure 8.3.2.5) extending 7 ft 0 in. above and 2 ft 0 in. below heater; also 7 ft 0 in. radius cylinder more than 7 ft 0 in. above unit heater	7 ft 0 in. radius extending and 2 ft 0 in. below heater
(b) Vertical downward discharge (for sprinklers below unit heater, see Figure 8.3.2.5)		7 ft 0 in. radius cylinder extending upward from an elevation 7 ft 0 in. above unit heater	7 ft 0 in. radius extending the unit heater elevation 7 ft 0 in. above unit heater
(3) Steam mains (uncovered)			
(a) Above	More than 2 ft 6 in.	2 ft 6 in. or less	
(b) Side and below	More than 1 ft 0 in.	1 ft 0 in. or less	
(c) Blowoff valve	More than 7 ft 0 in.		7 ft 0 in. or less

For SI units, 1 in. = 25.4 mm; 1 ft = 0.3048 m.

Table 8.3.2.5(b) Ratings of Sprinklers in Specified Locations

Location	Ordinary Degree Rating	Intermediate Degree Rating	High I
Skylights		Glass or plastic	
Attics	Ventilated	Unventilated	
Peaked roof: metal or thin boards, concealed or not concealed, insulated or uninsulated	Ventilated	Unventilated	
Flat roof: metal, not concealed	Ventilated or unventilated	Note: For uninsulated roof, climate and insulated or uninsulated occupancy can necessitate intermediate sprinklers. Check on job.	
Flat roof: metal, concealed, insulated or uninsulated	Ventilated	Unventilated	
Show windows	Ventilated	Unventilated	

Note: A check of job condition by means of thermometers might be necessary.

Table 8.3.2.5(c) Ratings of Sprinklers in Specified Residential Areas

Heat Source	Minimum Distance from Edge of Source to Ordinary-Temperature Sprinkler		Minimum Distance from Edge of Source to Intermediate-Temperature Sprinkler	
	in.	mm	in.	mm
Side of open or recessed fireplace	36	914	12	305
Front of recessed fireplace	60	1524	36	914
Coal- or wood-burning stove	42	1067	12	305
Kitchen range	18	457	9	229
Wall oven	18	457	9	229
Hot air flues	18	457	9	229
Uninsulated heat ducts	18	457	9	229
Uninsulated hot water pipes	12	305	6	152
Side of ceiling- or wall-mounted hot air diffusers	24	607	12	305
Front of wall-mounted hot air diffusers	36	914	18	457
Hot water heater or furnace	6	152	3	76
Light fixture:	6	152	3	76
0 W–250 W				
250 W–499 W	12	305	6	152

required, standard response sprinklers shall be permitted to be used.

8.3.3.4 When existing light hazard systems are converted to use quick-response or residential sprinklers, all sprinklers in a compartmented space shall be changed.

8.3.4 Small Orifice Sprinklers.

8.3.4.1 For light hazard occupancies not requiring as much water as is discharged by a sprinkler with a nominal K-factor of K-5.6 (80) operating at 7 psi (0.5 bar), sprinklers having a smaller orifice shall be permitted, subject to the following restrictions:

- (1) The system shall be hydraulically calculated.
- (2) Sprinklers with nominal K-factors of less than K-5.6 (80) shall be installed only in wet pipe sprinkler systems or in accordance with the limitations of 8.3.4.2 or 8.3.4.3.
- (3) A listed strainer shall be provided on the supply side of sprinklers with nominal K-factors of less than K-2.8 (40).

8.3.4.2 Sprinklers with nominal K-factors of less than K-5.6 (80) shall be permitted to be installed in conformance with 11.3.2 for protection against exposure fires.

8.3.4.3 Sprinklers with nominal K-factors of K-4.2 (60) shall be permitted to be installed on dry pipe systems where piping is corrosion resistant or internally galvanized.

8.3.5 Thread Size Limitations. Sprinklers having a K-factor exceeding K-5.6 (80) and having ½ in. (15 mm) National Pipe Thread (NPT) shall not be installed in new sprinkler systems.

8.4* Application of Sprinkler Types.

Sprinklers shall be selected for use as indicated in this section and shall be positioned and spaced as described in Section 8.5.

8.4.1 Standard Upright and Pendent Spray Sprinklers.

8.4.1.1 Upright and pendent spray sprinklers shall be permitted in all occupancy hazard classifications and building construction types.

8.4.1.2 Quick-response sprinklers shall not be permitted for use in extra hazard occupancies under the density-area design method.

8.4.2 Sidewall Spray Sprinklers. Sidewall sprinklers shall only be installed as follows:

- (1) Light hazard occupancies with smooth, horizontal or sloped, flat ceilings
- (2) Ordinary hazard occupancies with smooth, flat ceilings where specifically listed for such use
- (3) To protect areas below overhead doors

8.4.3 Extended Coverage Sprinklers. Extended coverage sprinklers shall only be installed as follows:

- (1) Unobstructed construction consisting of flat, smooth ceilings with a slope not

exceeding a pitch of one in six (a rise of two units in a run of 12 units, a roof slope of 16.7 percent)

- (2) Unobstructed or noncombustible obstructed construction, where specifically listed for such use
- (3) Within trusses or bar joists having web members not greater than 1 in. (25.4 mm) maximum dimension or where trusses are spaced greater than 7½ ft (2.3 m) on center and where the ceiling slope does not exceed a pitch of one in six (a rise of two units in a run of 12 units, a roof slope of 16.7 percent)
- (4) Under smooth, flat ceilings that have slopes not exceeding a pitch of one in three (a rise of four units in a run of 12 units, a roof slope of 33.3 percent), where specifically listed for such use

8.4.4 Open Sprinklers.

8.4.4.1 Open sprinklers shall be permitted to be used in deluge systems to protect special hazards or exposures or in other special locations.

8.4.4.2 Open sprinklers shall be installed in accordance with all applicable requirements of this standard for their automatic counterpart.

8.4.5 Residential Sprinklers.

8.4.5.1* Residential sprinklers shall be permitted in dwelling units and their adjoining corridors, provided they are installed in conformance with their listing.

8.4.5.2 Residential sprinklers shall be used only in wet systems unless specifically listed for use in dry systems or preaction systems.

8.4.5.3 Where residential sprinklers are installed in a compartment as defined in 3.3.5, all sprinklers within the compartment shall be of the fast-response type that meets the criteria of 3.6.1(a)(1).

8.4.6 Early Suppression Fast-Response (ESFR) Sprinklers.

8.4.6.1 ESFR sprinklers shall be used only in wet pipe systems unless specifically listed for use in dry systems where specifically listed for such service.

8.4.6.2 ESFR sprinklers shall be installed only in buildings where roof or ceiling slope above the sprinklers does not exceed a pitch of 2 in 12 (a rise of 2 units in a run of 12 units, a roof slope of 16.7 percent).

8.4.6.3* ESFR sprinklers shall be permitted for use in buildings with unobstructed or obstructed construction. Where depths of the solid structural members (beams, stem, etc.) exceed 12 in. (305 mm), ESFR sprinklers shall be installed in each channel formed by the solid structural members. Minimum sprinkler spacing and area of coverage shall comply with the requirements of 8.12.2 and 8.12.3.

8.4.6.4 Draft Curtains.

8.4.6.4.1 Where ESFR sprinkler systems are installed adjacent to sprinkler systems with

standard response sprinklers, a draft curtain of noncombustible construction and at least 2 ft (0.6 m) in depth shall be required to separate the two areas.

8.4.6.4.2 A clear aisle of at least 4 ft (1.2 m) centered below the draft curtain shall be maintained for separation.

8.4.6.5 Temperature Ratings. Sprinkler temperature ratings for ESFR sprinklers shall be ordinary unless 8.3.2 requires intermediate- or high-temperature ratings.

8.4.7 Large Drop Sprinklers.

8.4.7.1 Large drop sprinklers shall be permitted to be used in wet, dry, or preaction systems.

8.4.7.2* Galvanized Pipe.

8.4.7.2.1 Where steel pipe is used in preaction and dry pipe systems, piping materials shall be limited to internally galvanized steel.

8.4.7.2.2 Nongalvanized fittings shall be permitted.

8.4.7.3 Temperature Ratings.

8.4.7.3.1 Unless the requirements of 8.4.7.3.2, 8.4.7.3.3, or 8.4.7.3.4 are met, sprinkler temperature ratings shall be the same as those indicated in Table 8.3.2.5(a) and Table 8.3.2.5(b) or those used in large-scale fire testing to determine the protection requirements for the hazard involved.

8.4.7.3.2 Sprinklers of intermediate- and high-temperature ratings shall be installed in specific locations as required by 8.3.2.

8.4.7.3.3 In storage occupancies, ordinary, intermediate, or high temperature-rated sprinklers shall be used for wet pipe systems.

8.4.7.3.4 In storage occupancies, high temperature-rated sprinklers shall be used for dry pipe systems.

•

8.4.8 Special Sprinklers.

8.4.8.1* Special sprinklers that are intended for the protection of specific hazards or construction features shall be permitted where such devices have been evaluated and listed for performance under the following conditions:

- (1) Fire tests related to the intended hazard
- (2) Distribution of the spray pattern with respect to wetting of floors and walls
- (3) Distribution of the spray pattern with respect to obstructions
- (4) Evaluation of the thermal sensitivity of the sprinkler
- (5) Performance under horizontal or sloped ceilings
- (6) Area of design
- (7) Allowable clearance to ceilings

8.4.8.2 Special sprinklers shall maintain the following characteristics:

- (1) Orifice size shall be in accordance with 6.2.3.
- (2) Temperature ratings shall be in accordance with Table 6.2.5.1.
- (3) The protection area of coverage shall not exceed 400 ft² (36 m²) for light hazard and ordinary hazard occupancies.
- (4) The protection area of coverage shall not exceed 196 ft² (17 m²) for extra hazard and high-piled storage occupancies.

8.4.9 Specific Application Control Mode Sprinklers. Specific application control mode sprinklers shall be installed in strict accordance with their listing.

8.4.10 Dry Sprinklers.

8.4.10.1 Where dry sprinklers are connected to wet pipe sprinkler systems protecting areas subject to freezing temperatures, sprinklers of sufficient length shall be used to avoid freezing of the water filled pipes due to conduction.

8.4.10.2* Where dry sprinklers are connected to wet pipe sprinkler systems protecting insulated freezer structures, the clearance space around the sprinkler barrel shall be sealed.

8.5 Position, Location, Spacing, and Use of Sprinklers.

8.5.1 General.

8.5.1.1 Sprinklers shall be located, spaced, and positioned in accordance with the requirements of Section 8.5.

8.5.1.2 Sprinklers shall be positioned to provide protection of the area consistent with the overall objectives of this standard by controlling the positioning and allowable area of coverage for each sprinkler.

8.5.1.3 The requirements of 8.5.2 through 8.5.7 shall apply to all sprinkler types unless modified by more restrictive rules in Section 8.6 through Section 8.12.

8.5.2 Protection Areas per Sprinkler.

8.5.2.1 Determination of the Protection Area of Coverage.

8.5.2.1.1 The protection area of coverage per sprinkler (A_s) shall be determined as follows:

- (1) Along branch lines as follows:
 - (a) Determine distance between sprinklers (or to wall or obstruction in the case of the end sprinkler on the branch line) upstream and downstream.
 - (b) Choose the larger of either twice the distance to the wall or the distance to the next sprinkler.
 - (c) This dimension will be defined as S .
- (2) Between branch lines as follows:

- (a) Determine perpendicular distance to the sprinkler on the adjacent branch line (or to a wall or obstruction in the case of the last branch line) on each side of the branch line on which the subject sprinkler is positioned.
- (b) Choose the larger of either twice the distance to the wall or obstruction or the distance to the next sprinkler.
- (c) This dimension will be defined as L .

8.5.2.1.2 The protection area of coverage of the sprinkler shall be established by multiplying the S dimension by the L dimension, as follows:

$$A_s = S \times L$$

8.5.2.2 Maximum Protection Area of Coverage.

8.5.2.2.1 The maximum allowable protection area of coverage for a sprinkler (A_s) shall be in accordance with the value indicated in the section for each type or style of sprinkler.

8.5.2.2.2 The maximum area of coverage of any sprinkler shall not exceed 400 ft² (36 m²).

8.5.3 Sprinkler Spacing.

8.5.3.1 Maximum Distance Between Sprinklers.

8.5.3.1.1 The maximum distance permitted between sprinklers shall be based on the centerline distance between adjacent sprinklers.

8.5.3.1.2 The maximum distance shall be measured along the slope of the ceiling.

8.5.3.1.3 The maximum distance permitted between sprinklers shall comply with the value indicated in the applicable section for each type or style of sprinkler.

8.5.3.2 Maximum Distance from Walls.

8.5.3.2.1 The distance from sprinklers to walls shall not exceed one-half of the allowable maximum distance between sprinklers.

8.5.3.2.2 The distance from the wall to the sprinkler shall be measured perpendicular to the wall.

8.5.3.2.3 The distance from the wall to the sprinkler shall be measured to the wall behind furniture, such as wardrobes, cabinets, and trophy cases.

8.5.3.2.4 The distance from the wall to the sprinkler shall be measured to the wall when sprinklers are spaced near windows and no additional floor space is created.

8.5.3.3 Minimum Distance from Walls.

8.5.3.3.1 The minimum distance permitted between a sprinkler and the wall shall comply with the value indicated in the applicable section for each type or style of sprinkler.

8.5.3.3.2 The distance from the wall to the sprinkler shall be measured perpendicular to the wall.

8.5.3.4 Minimum Distance Between Sprinklers.

8.5.3.4.1 A minimum distance shall be maintained between sprinklers to prevent operating sprinklers from wetting adjacent sprinklers and to prevent skipping of sprinklers.

8.5.3.4.2 The minimum distance permitted between sprinklers shall comply with the value indicated in the applicable section for each type or style of sprinkler.

8.5.4 Deflector Position.

8.5.4.1* Distance Below Ceilings.

8.5.4.1.1 The distances between the sprinkler deflector and the ceiling above shall be selected based on the type of sprinkler and the type of construction.

8.5.4.1.2 For corrugated metal deck roofs up to 3 in. (76 mm) in depth, the distance shall be measured to the sprinkler from the bottom of the deck. For deeper decks, the distance shall be measured to the highest point on the deck.

8.5.4.2 Deflector Orientation. Deflectors of sprinklers shall be aligned parallel to ceilings, roofs, or the incline of stairs.

8.5.5 Obstructions to Sprinkler Discharge.

8.5.5.1* Performance Objective. Sprinklers shall be located so as to minimize obstructions to discharge as defined in 8.5.5.2 and 8.5.5.3, or additional sprinklers shall be provided to ensure adequate coverage of the hazard. (*See Figure A.8.5.5.1.*)

8.5.5.2* Obstructions to Sprinkler Discharge Pattern Development.

8.5.5.2.1 Continuous or noncontinuous obstructions less than or equal to 18 in. (457 mm) below the sprinkler deflector that prevent the pattern from fully developing shall comply with 8.5.5.2.

8.5.5.2.2 Sprinklers shall be positioned in accordance with the minimum distances and special requirements of Section 8.6 through Section 8.12 so that they are located sufficiently away from obstructions such as truss webs and chords, pipes, columns, and fixtures.

8.5.5.3* Obstructions That Prevent Sprinkler Discharge from Reaching the Hazard.

Continuous or noncontinuous obstructions that interrupt the water discharge in a horizontal plane more than 18 in. (457 mm) below the sprinkler deflector in a manner to limit the distribution from reaching the protected hazard shall comply with 8.5.5.3.

8.5.5.3.1 Sprinklers shall be installed under fixed obstructions over 4 ft (1.2 m) wide such as ducts, decks, open grate flooring, cutting tables, and overhead doors.

8.5.5.3.2 Sprinklers shall not be required under obstructions that are not fixed in place such as conference tables.

8.5.5.3.3* Sprinklers installed under open gratings shall be of the intermediate level/rack storage type or otherwise shielded from the discharge of overhead sprinklers.

8.5.6* Clearance to Storage.

8.5.6.1* Unless the requirements of 8.5.6.2, 8.5.6.3, 8.5.6.4, or 8.5.6.5 are met, the clearance between the deflector and the top of storage shall be 18 in. (457 mm) or greater.

8.5.6.2 Where other standards specify greater clearance to storage minimums, they shall be followed.

8.5.6.3 A minimum clearance to storage of 36 in. (914 mm) shall be permitted for special sprinklers.

8.5.6.4 A minimum clearance to storage of less than 18 in. (457 mm) between the top of storage and ceiling sprinkler deflectors shall be permitted where proven by successful large-scale fire tests for the particular hazard.

8.5.6.5 The clearance from the top of storage to sprinkler deflectors shall be not less than 36 in. (914 mm) where rubber tires are stored.

8.5.7 Skylights. Sprinklers shall be permitted to be omitted from skylights and similar ceiling pockets not exceeding 32 ft² (3 m²) in area, regardless of hazard classification, that are separated by at least 10 ft (3 m) horizontally from any other skylight or unprotected ceiling pocket. Skylights not exceeding 32 ft² (3 m²) shall be permitted to have a plastic cover.

8.6 Standard Pendent and Upright Spray Sprinklers.

8.6.1 General. All requirements of Section 8.5 shall apply to standard pendent and upright spray sprinklers except as modified in Section 8.6.

8.6.2 Protection Areas per Sprinkler (Standard Pendent and Upright Spray Sprinklers).

8.6.2.1 Determination of the Protection Area of Coverage.

8.6.2.1.1 Except as permitted by 8.6.2.1.2, the protection area of coverage per sprinkler (A_s) shall be determined in accordance with 8.5.2.1.

8.6.2.1.2 The requirements of 8.6.2.1.1 shall not apply in a small room as defined in 3.3.15; the protection area of coverage for each sprinkler in the small room shall be the area of the room divided by the number of sprinklers in the room.

8.6.2.2 Maximum Protection Area of Coverage.

8.6.2.2.1* The maximum allowable protection area of coverage for a sprinkler (A_s) shall be in accordance with the value indicated in Table 8.6.2.2.1(a) through Table 8.6.2.2.1(d).

Table 8.6.2.2.1(a) Protection Areas and Maximum Spacing (Standard Spray Upright/Pendent) for Light Hazard

Construction Type	System Type	Protection Area		Spacing (
		ft ²	m ²	ft
Noncombustible obstructed and unobstructed and combustible unobstructed with members 3 ft (0.91 m) or more on center	Pipe schedule	200	18.6	15

Table 8.6.2.2.1(a) Protection Areas and Maximum Spacing (Standard Spray Upright/Pendent) for Light Hazard

Construction Type	System Type	Protection Area		Spacing (
		ft ²	m ²	ft
Noncombustible obstructed and unobstructed and combustible unobstructed with members 3 ft (0.91 m) or more on center	Hydraulically calculated	225	20.9	15
Combustible obstructed with members 3 ft (0.91 m) or more on center	All	168	15.6	15
Combustible obstructed or unobstructed with members less than 3 ft (0.91 m) on center	All	130	12.1	15
Combustible concealed space under a pitched roof having combustible wood joist or wood truss construction with members less than 3 ft (0.91 m) on center with slopes having a pitch of 4 in 12 or greater	All	120	11.1	15 parallel to the slope 10 perpendicular to the slope*

*Where the dimension perpendicular to the slope exceeds 8 ft (2.4 m), the minimum pressure shall be 20 psi (1.4 bar)

Table 8.6.2.2.1(b) Protection Areas and Maximum Spacing (Standard Spray Upright/Standard Spray Pendent) for Ordinary Hazard

Construction Type	System Type	Protection Area		Spacing (maximum)	
		ft ²	m ²	ft	m
All	All	130	12.1	15	4.6

Table 8.6.2.2.1(c) Protection Areas and Maximum Spacing (Standard Spray Upright/Standard Spray Pendent) for Extra Hazard

Construction Type	System Type	Protection Area		Spacing (maximum)	
		ft ²	m ²	ft	m
All	Pipe schedule	90	8.4	12	3.7
				[In buildings with storage bays 25 ft (7.6 m) wide, 12 ft 6 in. (3.8 m) shall be permitted.]	
All	Hydraulically calculated with density ≥ 0.25	100	9.3	12	3.7
				[In buildings with storage bays 25 ft (7.6 m) wide, 12 ft 6 in. (3.8 m) shall be permitted.]	

Table 8.6.2.2.1(c) Protection Areas and Maximum Spacing (Standard Spray Upright/Standard Spray Pendent) for Extra Hazard

Construction Type	System Type	Protection Area		Spacing (maximum)	
		ft ²	m ²	ft	m
All	Hydraulically calculated with density <0.25	130	12.1	15	4.6

Table 8.6.2.2.1(d) Protection Areas and Maximum Spacing (Standard Spray Upright/Standard Spray Pendent) for High-Piled Storage

Construction Type	System Type	Protection Area		Spacing (maximum)	
		ft ²	m ²	ft	m
All	Hydraulically calculated with density ≥ 0.25	100	9.3	12	3.7
				[In buildings with storage bays 25 ft (7.6 m) wide, 12 ft 6 in. (3.8 m) shall be permitted.]	
All	Hydraulically calculated with density <0.25	130	12.1	15	4.6

8.6.2.2.2 In any case, the maximum area of coverage of a sprinkler shall not exceed 225 ft² (21 m²).

8.6.3 Sprinkler Spacing (Standard Pendent and Upright Spray Sprinklers).

8.6.3.1 Maximum Distance Between Sprinklers. The maximum distance permitted between sprinklers shall comply with Table 8.6.2.2.1(a) through Table 8.6.2.2.1(d).

8.6.3.2 Maximum Distance from Walls.

8.6.3.2.1 The distance from sprinklers to walls shall not exceed one-half of the allowable distance between sprinklers as indicated in Table 8.6.2.2.1(a) through Table 8.6.2.2.1(d).

8.6.3.2.2 The distance from the wall to the sprinkler shall be measured perpendicular to the wall.

8.6.3.2.3* The requirements of 8.6.3.2.1 shall not apply where walls are angled or irregular, and the maximum horizontal distance between a sprinkler and any point of floor area protected by that sprinkler shall not exceed 0.75 times the allowable distance permitted between sprinklers, provided the maximum perpendicular distance is not exceeded.

8.6.3.2.4* The requirements of 8.6.3.2.1 shall not apply within small rooms as defined in 3.3.15, sprinklers shall be permitted to be located not more than 9 ft (2.7 m) from any single

wall, and sprinkler spacing limitations of 8.6.3 and area limitations of Table 8.6.2.2.1(a) shall not be exceeded.

8.6.3.2.5 Under curved surfaces, the horizontal distance shall be measured at the floor level from the wall, or the intersection of the curved surface and the floor to the nearest sprinkler shall not be greater than one-half the allowable distance between sprinklers.

8.6.3.3 Minimum Distances from Walls. Sprinklers shall be located a minimum of 4 in. (102 mm) from a wall.

8.6.3.4 Minimum Distances Between Sprinklers.

8.6.3.4.1 Unless the requirements of 8.6.3.4.2, 8.6.3.4.3, or 8.6.3.4.4 are met, sprinklers shall be spaced not less than 6 ft (1.8 m) on center.

8.6.3.4.2 Sprinklers shall be permitted to be placed less than 6 ft (1.8 m) on center where the following conditions are satisfied:

- (1) Baffles shall be installed and located midway between sprinklers and arranged to protect the actuating elements.
- (2) Baffles shall be of noncombustible or limited-combustible material that will stay in place before and during sprinkler operation.
- (3) Baffles shall be not less than 8 in. (203 mm) wide and 6 in. (152 mm) high.
- (4) The tops of baffles shall extend between 2 in. and 3 in. (51 mm and 76 mm) above the deflectors of upright sprinklers.
- (5) The bottoms of baffles shall extend downward to a level at least even with the deflectors of pendent sprinklers.

8.6.3.4.3 In-rack sprinklers shall be permitted to be placed less than 6 ft (1.8 m) on center.

8.6.3.4.4 Old-style sprinklers protecting fur storage vaults shall be permitted to be placed less than 6 ft (1.8 m) on center.

8.6.4 Deflector Position (Standard Pendent and Upright Spray Sprinklers).

8.6.4.1 Distance Below Ceilings.

8.6.4.1.1 Unobstructed Construction.

8.6.4.1.1.1 Under unobstructed construction, the distance between the sprinkler deflector and the ceiling shall be a minimum of 1 in. (25.4 mm) and a maximum of 12 in. (305 mm) throughout the area of coverage of the sprinkler.

8.6.4.1.1.2 The requirements of 8.6.4.1.1.1 shall not apply where ceiling-type sprinklers (concealed, recessed, and flush types) have the operating element above the ceiling and the deflector located nearer to the ceiling where installed in accordance with their listing.

8.6.4.1.1.3 The requirements of 8.6.4.1.1.1 shall not apply for light and ordinary hazard occupancies with ceilings of noncombustible or limited combustibles construction. Where there is a vertical change in ceiling elevation within the area of coverage of the sprinkler

creating a distance of more than 36 in. (914 mm) between the upper ceiling and the sprinkler deflector, a vertical plane extending down from the ceiling at the change in elevation shall be considered a wall for the purpose of sprinkler spacing. Where the distance between the upper ceiling and the sprinkler deflector is less than or equal to 36 in. (914 mm), the sprinklers shall be permitted to be spaced as though the ceiling was flat, provided the obstruction rules and ceiling pocket rules are observed. (See Figure 8.6.4.1.1.3.)

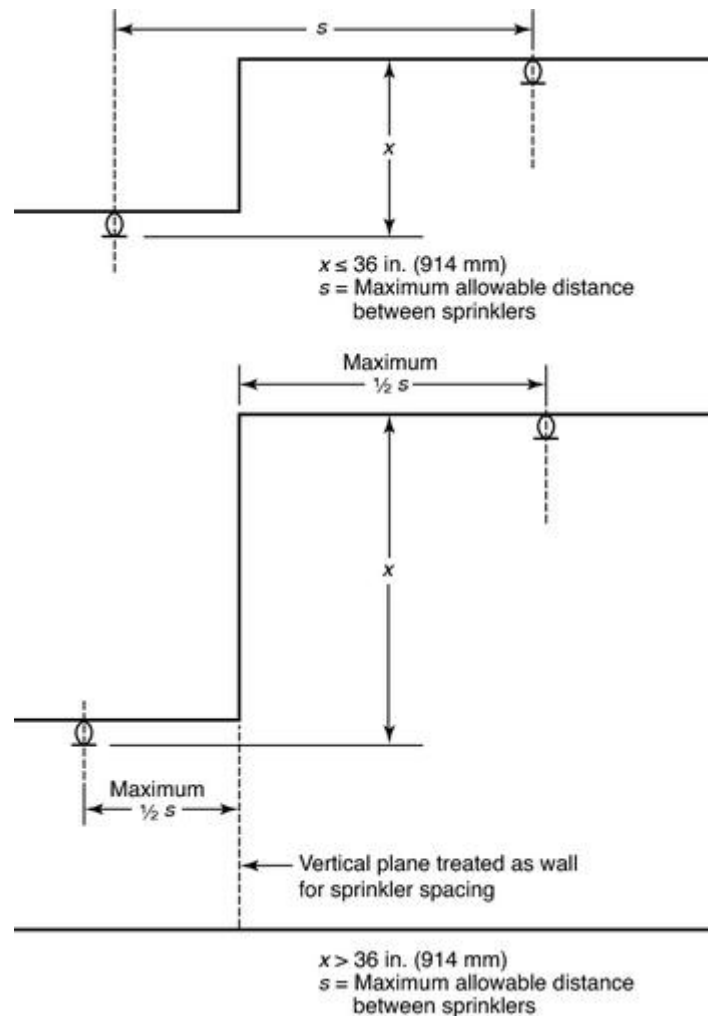

FIGURE 8.6.4.1.1.3 Vertical Changes in Ceiling Elevations.

8.6.4.1.2 Obstructed Construction. Under obstructed construction, the sprinkler deflector shall be located in accordance with one of the following arrangements:

- (1) Installed with the deflectors within the horizontal planes of 1 in. to 6 in. (25.4 mm to 152 mm) below the structural members and a maximum distance of 22 in. (559 mm) below the ceiling/roof deck
- (2) Installed with the deflectors at or above the bottom of the structural member to a maximum of 22 in. (559 mm) below the ceiling/roof deck where the sprinkler is installed in conformance with 8.6.5.1.2
- (3) Installed in each bay of obstructed construction, with the deflectors located a

- minimum of 1 in. (25.4 mm) and a maximum of 12 in. (305 mm) below the ceiling
- (4) Installed with the deflectors within the horizontal planes 1 in. to 6 in. (25.4 mm to 152 mm) below composite wood joists to a maximum distance of 22 in. (559 mm) below the ceiling/roof deck only where joist channels are fire-stopped to the full depth of the joists with material equivalent to the web construction so that individual channel areas do not exceed 300 ft² (27.9 m²)
 - (5)* Installed with deflectors of sprinklers under concrete tee construction with stems spaced less than 7½ ft (2.3 m) but more than 3 ft (0.91 m) on centers, regardless of the depth of the tee, located at or above a horizontal plane 1 in. (25.4 mm) below the bottom of the stems of the tees and shall comply with Table 8.6.5.1.2

8.6.4.1.3 Peaked Roofs and Ceilings.

8.6.4.1.3.1 Unless the requirements of 8.6.4.1.3.2 or 8.6.4.1.3.3 are met, sprinklers under or near the peak of a roof or ceiling shall have deflectors located not more than 36 in. (914 mm) vertically down from the peak as indicated in Figure 8.6.4.1.3.1(a) and Figure 8.6.4.1.3.1(b).

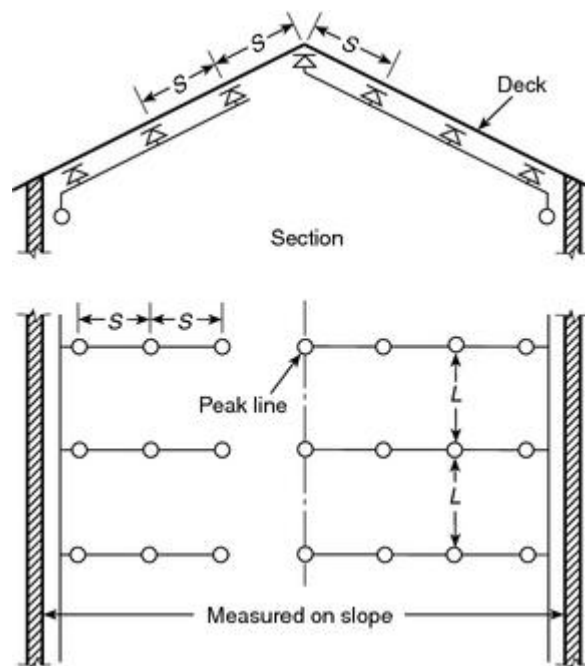

FIGURE 8.6.4.1.3.1(a) Sprinklers Under Pitched Roofs with Sprinkler Directly Under Peak; Branch Lines Run Up the Slope.

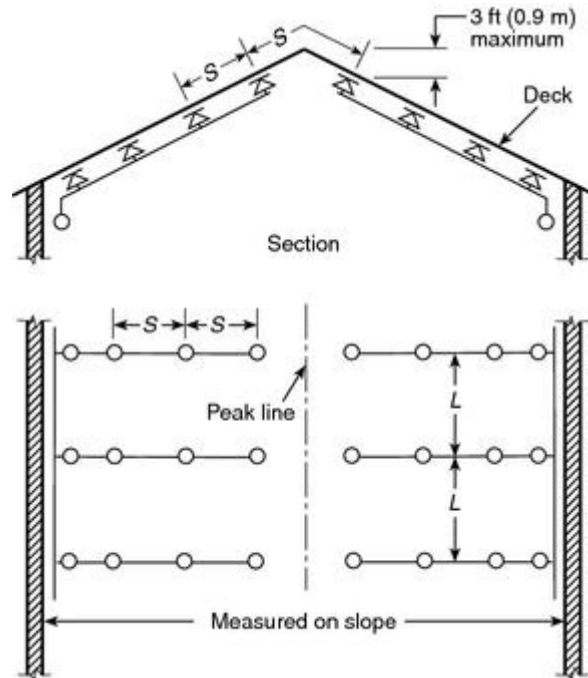

FIGURE 8.6.4.1.3.1(b) Sprinklers at Pitched Roofs; Branch Lines Run Up the Slope.

8.6.4.1.3.2* Under saw-toothed roofs, sprinklers at the highest elevation shall not exceed a distance of 36 in. (914 mm) measured down the slope from the peak.

8.6.4.1.3.3* Under a steeply pitched surface, the distance from the peak to the deflectors shall be permitted to be increased to maintain a horizontal clearance of not less than 24 in. (610 mm) from other structural members as indicated in Figure 8.6.4.1.3.3.

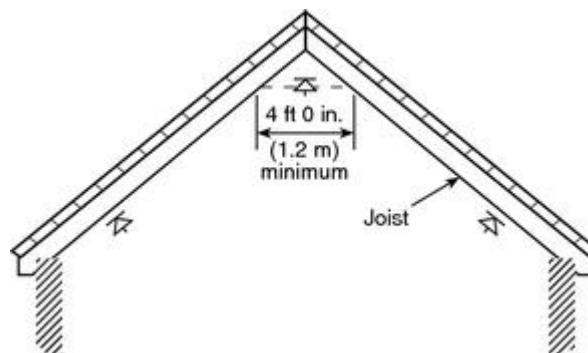
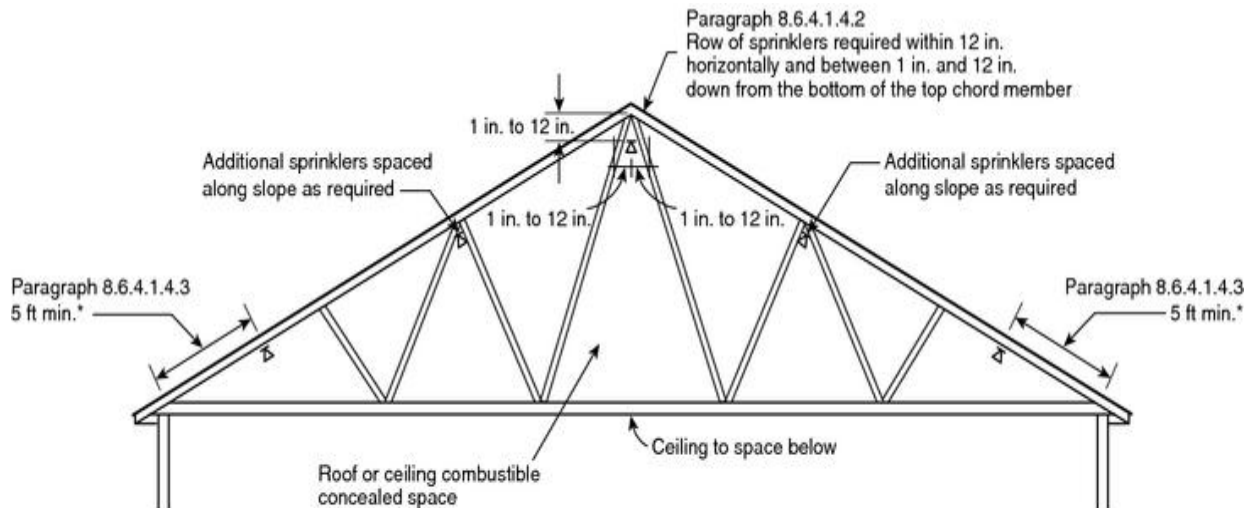

FIGURE 8.6.4.1.3.3 Horizontal Clearance for Sprinklers at Peak of Pitched Roof.

8.6.4.1.4 Sprinklers Under a Roof or Ceiling in Combustible Concealed Spaces of Wood Joist or Wood Truss Construction with Members 3 ft (0.91 m) or Less on Center and a Slope Having a Pitch of 4 in 12 or Greater. (See Figure 8.6.4.1.4.)



For SI units, 1 in. = 25.4 mm; 1 ft = 0.3048 m.

*Note: The 5 ft minimum dimension is measured from the intersection of the upper and lower truss chords, or the wood rafters and ceiling joists.

FIGURE 8.6.4.1.4 Sprinklers Under a Roof or Ceiling in Combustible Concealed Spaces of Wood Joist or Wood Truss Construction with Members 3 ft (0.91 m) or Less on Center and a Slope Having a Pitch of 4 in 12 or Greater.

8.6.4.1.4.1 Sprinklers under a roof or ceiling in combustible concealed spaces of wood joist or wood truss construction with members 3 ft (0.91 m) or less on center and a slope having a pitch of 4 in 12 or greater shall be quick response.

8.6.4.1.4.2 Sprinklers under a roof or ceiling in combustible concealed spaces of wood joist or wood truss construction with members 3 ft (0.91 m) or less on center and a slope having a pitch of 4 in 12 or greater shall be installed so that a row of sprinklers is installed within 12 in. (305 mm) horizontally of the peak and between 1 in. and 12 in. (25.4 mm and 305 mm) down from the bottom of the top chord member.

8.6.4.1.4.3 Sprinklers under a roof or ceiling in combustible concealed spaces of wood joist or wood truss construction with members 3 ft (0.91 m) or less on center and a slope having a pitch of 4 in 12 or greater shall be installed so that the sprinklers installed along the eave are located not less than 5 ft (1.52 m) from the intersection of the truss chords, or the wood rafters and ceiling joists.

8.6.4.1.4.4 Sprinklers under a roof or ceiling in combustible concealed spaces, consisting of combustible wood joist or wood truss construction with members spaced less than 3 ft (0.91 m) on center, used with slopes with a pitch at or exceeding 4 in 12, and using standard spray sprinklers, shall be quick-response having pressures in accordance with the requirements of Table 8.6.2.2.1(a).

8.6.4.1.5 Double Joist Obstructions.

8.6.4.1.5.1 Unless the requirements of 8.6.4.1.5.2 are met, where there are two sets of joists under a roof or ceiling, and there is no flooring over the lower set, sprinklers shall be

installed above and below the lower set of joists where there is a clearance of 6 in. (152 mm) or more between the top of the lower joist and the bottom of the upper joist as indicated in Figure 8.6.4.1.5.1.

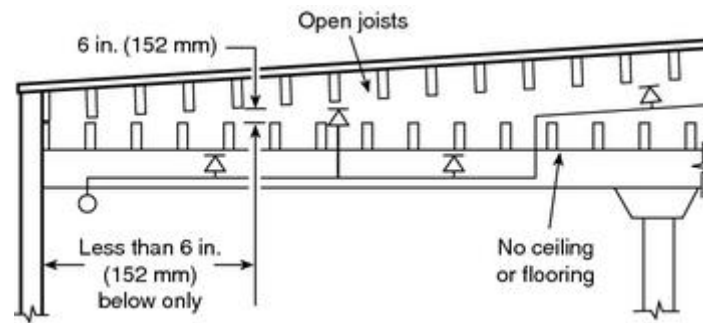

FIGURE 8.6.4.1.5.1 Arrangement of Sprinklers Under Two Sets of Open Joists — No Sheathing on Lower Joists.

8.6.4.1.5.2 Sprinklers shall be permitted to be omitted from below the lower set of joists where at least 18 in. (457 mm) is maintained between the sprinkler deflector and the top of the lower joist.

8.6.4.2 Deflector Orientation.

8.6.4.2.1 Unless the requirements of 8.6.4.2.2 or 8.6.4.2.3 are met, deflectors of sprinklers shall be aligned parallel to ceilings, roofs, or the incline of stairs.

8.6.4.2.2 Where sprinklers are installed in the peak below a sloped ceiling or roof surface, the sprinkler shall be installed with the deflector horizontal.

8.6.4.2.3 Roofs having a pitch not exceeding 2 in 12 (16.7 percent) are considered horizontal in the application of 8.6.4.2, and sprinklers shall be permitted to be installed with deflectors horizontal.

8.6.5 Obstructions to Sprinkler Discharge (Standard Pendent and Upright Spray Sprinklers).

8.6.5.1 Performance Objective.

8.6.5.1.1 Sprinklers shall be located so as to minimize obstructions to discharge as defined in 8.6.5.2 and 8.6.5.3, or additional sprinklers shall be provided to ensure adequate coverage of the hazard.

8.6.5.1.2 Sprinklers shall be arranged to comply with one of the following arrangements:

- (1) Subsection 8.5.5.2, Table 8.6.5.1.2, and Figure 8.6.5.1.2(a).
- (2) Sprinklers shall be permitted to be spaced on opposite sides of obstructions not exceeding 4 ft (1.2 m) in width, provided the distance from the centerline of the obstruction to the sprinklers does not exceed one-half the allowable distance permitted between sprinklers.
- (3) Obstructions located against the wall and that are not over 30 in. (762 mm) in width

shall be permitted to be protected in accordance with Figure 8.6.5.1.2(b).

Table 8.6.5.1.2 Positioning of Sprinklers to Avoid Obstructions to Discharge (SSU/SSP)

Distance from Sprinklers to Side of Obstruction (<i>A</i>)	Maximum Allowable Distance of Deflector Above Bottom of Obstruction (in.) (<i>B</i>)
Less than 1 ft	0
1 ft to less than 1 ft 6 in.	2½
1 ft 6 in. to less than 2 ft	3½
2 ft to less than 2 ft 6 in.	5½
2 ft 6 in. to less than 3 ft	7½
3 ft to less than 3 ft 6 in.	9½
3 ft 6 in. to less than 4 ft	12
4 ft to less than 4 ft 6 in.	14
4 ft 6 in. to less than 5 ft	16½
5 ft to less than 5 ft 6 in.	18
5 ft 6 in. to less than 6 ft	20
6 ft to less than 6 ft 6 in.	24
6 ft 6 in. to less than 7 ft	30
7 ft to less than 7 ft 6 in.	35

For SI units, 1 in. = 25.4 mm; 1 ft = 0.3048 m.

Note: For (*A*) and (*B*), refer to Figure 8.6.5.1.2(a).

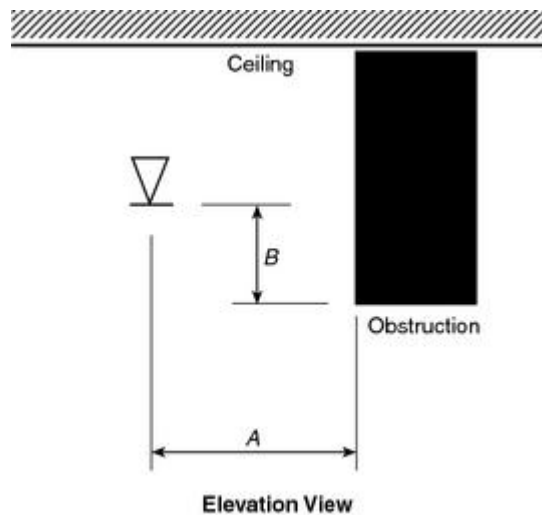

FIGURE 8.6.5.1.2(a) Positioning of Sprinklers to Avoid Obstructions to Discharge (SSU/SSP).

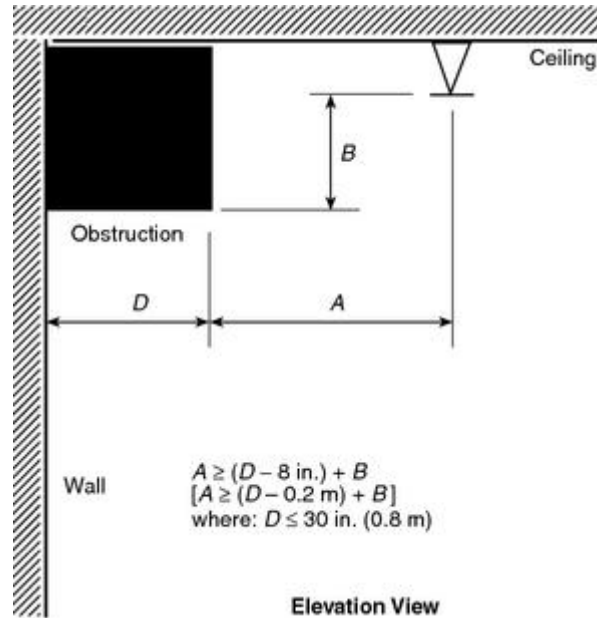

FIGURE 8.6.5.1.2(b) Obstructions Against Walls (SSU/SSP).

8.6.5.2 Obstructions to Sprinkler Discharge Pattern Development.

8.6.5.2.1 General.

8.6.5.2.1.1 Continuous or noncontinuous obstructions less than or equal to 18 in. (457 mm) below the sprinkler deflector that prevent the pattern from fully developing shall comply with 8.6.5.2.

8.6.5.2.1.2 Regardless of the rules of 8.6.5.2, solid continuous obstructions shall meet the applicable requirements of 8.6.5.1.2.

8.6.5.2.1.3* Unless the requirements of 8.6.5.2.1.4 through 8.6.5.2.1.9 are met, sprinklers shall be positioned away from obstructions a minimum distance of three times the maximum dimension of the obstruction (e.g., structural members, pipe, columns, and fixtures). The maximum clear distance required shall be 24 in. (609 mm) in accordance with Figure 8.6.5.2.1.3.

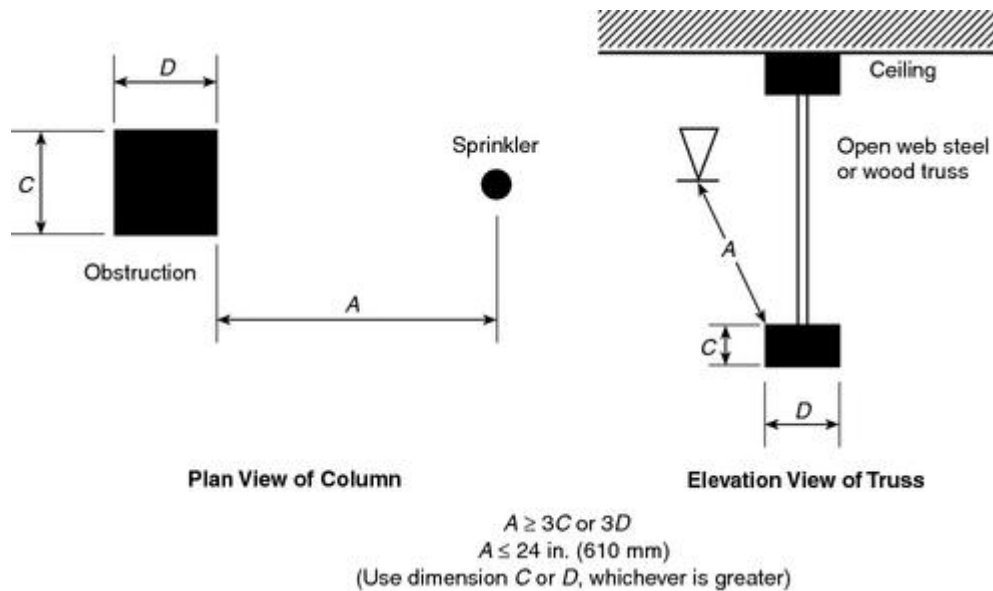

FIGURE 8.6.5.2.1.3 Minimum Distance from Obstruction (SSU/SSP).

8.6.5.2.1.4* For light and ordinary hazard occupancies, structural members only shall be considered when applying the requirements of 8.6.5.2.1.3.

8.6.5.2.1.5 Sprinklers shall be permitted to be spaced on opposite sides of the obstruction where the distance from the centerline of the obstruction to the sprinklers does not exceed one-half the allowable distance between sprinklers.

8.6.5.2.1.6 Sprinklers shall be permitted to be located one-half the distance between the obstructions where the obstruction consists of open trusses 20 in. (0.51 m) or greater apart [24 in. (0.61 m) on center], provided that all truss members are not greater than 4 in. (102 mm) (nominal) in width.

8.6.5.2.1.7 Sprinklers shall be permitted to be installed on the centerline of a truss or bar joist or directly above a beam, provided that the truss chord or beam dimension is not more than 8 in. (203 mm) and the sprinkler deflector is located at least 6 in. (152 mm) above the structural member and where the sprinkler is positioned at a distance three times greater than the maximum dimension of the web members away from the web members.

8.6.5.2.1.8 The requirements of 8.6.5.2.1.3 shall not apply to sprinkler system piping less than 3 in. (80 mm) in diameter.

8.6.5.2.1.9 The requirements of 8.6.5.2.1.3 shall not apply to sprinklers positioned with respect to obstructions in accordance with 8.6.5.1.2.

8.6.5.2.2 Suspended or Floor-Mounted Vertical Obstructions. The distance from sprinklers to privacy curtains, freestanding partitions, room dividers, and similar obstructions

8.6.5.2.1.8 The requirements of 8.6.5.2.1.3 shall not apply to sprinkler system piping less than 3 in. (80 mm) in diameter.

8.6.5.2.1.9 The requirements of 8.6.5.2.1.3 shall not apply to sprinklers positioned with respect to obstructions in accordance with 8.6.5.1.2.

8.6.5.2.2 Suspended or Floor-Mounted Vertical Obstructions. The distance from sprinklers to privacy curtains, freestanding partitions, room dividers, and similar obstructions in light hazard occupancies shall be in accordance with Table 8.6.5.2.2 and Figure 8.6.5.2.2.

Table 8.6.5.2.2 Suspended or Floor-Mounted Obstructions in Light Hazard Occupancies Only (SSU/SSP)

Horizontal Distance (A)	Minimum Vertical Distance Below Deflector (in.) (B)
6 in. or less	3
More than 6 in. to 9 in.	4
More than 9 in. to 12 in.	6
More than 12 in. to 15 in.	8
More than 15 in. to 18 in.	9½
More than 18 in. to 24 in.	12½
More than 24 in. to 30 in.	15½
More than 30 in.	18

For SI units, 1 in. = 25.4 mm.

Note: For (A) and (B), refer to Figure 8.6.5.2.2.

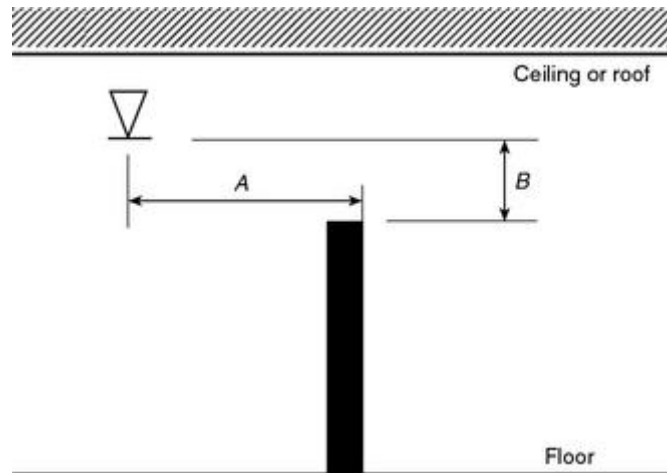

FIGURE 8.6.5.2.2 Suspended or Floor-Mounted Obstructions in Light Hazard Occupancies Only (SSU/SSP).

8.6.5.2.2.1* In light hazard occupancies, privacy curtains that are supported by fabric mesh on ceiling track and have openings in the mesh equal to 70 percent or greater and extend a minimum of 22 in. (559 mm) from ceiling shall not be considered obstructions as shown in 8.6.5.2.2.

8.6.5.3* Obstructions That Prevent Sprinkler Discharge from Reaching the Hazard.

8.6.5.3.1 Continuous or noncontinuous obstructions that interrupt the water discharge in a horizontal plane more than 18 in. (457 mm) below the sprinkler deflector in a manner to limit the distribution from reaching the protected hazard shall comply with 8.6.5.3.

8.6.5.3.2 The requirements of 8.6.5.3 shall also apply to obstructions 18 in. (457 mm) or less below the sprinkler for light and ordinary hazard occupancies.

8.6.5.3.3 Sprinklers shall be installed under fixed obstructions over 4 ft (1.2 m) wide, such as ducts, decks, open grate flooring, cutting tables, and overhead doors.

8.6.5.3.4 Sprinklers shall not be required below obstructions that are not fixed in place, such as conference tables.

8.6.5.3.5 Sprinklers installed under open gratings shall be of the intermediate level/rack storage type or otherwise shielded from the discharge of overhead sprinklers.

8.6.6* Clearance to Storage (Standard Pendent and Upright Spray Sprinklers).

8.6.6.1 The clearance between the deflector and the top of storage shall be 18 in. (457 mm) or greater.

8.6.6.2 Where other standards specify greater clearance to storage minimums, they shall be followed.

8.6.7 Ceiling Pockets.

8.6.7.1 Sprinklers shall be required in all ceiling pockets.

8.6.7.2 The requirements of 8.6.7.1 shall not apply where all of the following are met:

- (1) The total volume of the unprotected ceiling pocket does not exceed 1000 ft³ (28.3 m³).
- (2) The depth of the unprotected pocket does not exceed 36 in. (914 mm).
- (3) The entire floor under the unprotected ceiling pocket is protected by the sprinklers at the lower ceiling elevation.
- (4) Each unprotected ceiling pocket is separated from any adjacent unprotected ceiling pocket by a minimum 10 ft (3.05 m) horizontal distance.
- (5) The unprotected ceiling pocket is constructed of noncombustible or limited combustible construction.
- (6) Skylights not exceeding 32 ft² (3 m²) shall be permitted to have a plastic cover.
- (7) Quick response sprinklers are utilized throughout the compartment.

8.7 Sidewall Standard Spray Sprinklers.

8.7.1 General. All requirements of Section 8.5 shall apply to sidewall standard spray sprinklers except as modified in Section 8.7.

8.7.2 Protection Areas per Sprinkler (Standard Sidewall Spray Sprinklers).

8.7.2.1 Determination of the Protection Area of Coverage.

8.7.2.1.1 The protection area of coverage per sprinkler (A_s) shall be determined as follows:

- (1) Along the wall as follows:
 - (a) Determine the distance between sprinklers along the wall (or to the end wall or obstruction in the case of the end sprinkler on the branch line) upstream and downstream.
 - (b) Choose the larger of either twice the distance to the end wall or the distance to the next sprinkler.
 - (c) This dimension will be defined as S .
- (2) Across the room as follows:
 - (a) Determine the distance from the wall on which the sprinkler is installed to the wall opposite the sprinklers or to the midpoint of the room where sprinklers are installed on two opposite walls (*see 8.7.3.1.5 and 8.7.3.1.6*).
 - (b) This dimension will be defined as L .

8.7.2.1.2 The protection area of the sprinkler shall be established by multiplying the S dimension by the L dimension, as follows:

$$A_s = S \times L$$

8.7.2.2 Maximum Protection Area of Coverage.

8.7.2.2.1 The maximum allowable protection area of coverage for a sprinkler (A_s) shall be in accordance with the value indicated in Table 8.7.2.2.1.

Table 8.7.2.2.1 Protection Areas and Maximum Spacing (Standard Sidewall Sprinklers)

	Light Hazard		Ordinary Hazard
	Combustible Finish	Noncombustible or Limited-Combustible Finish	Combustible Finish
Maximum distance along the wall (S)	14 ft	14 ft	10 ft
Maximum room width (L)	12 ft	14 ft	10 ft
Maximum protection area	120 ft ²	196 ft ²	80 ft ²

For SI units, 1 ft = 0.3048 m; 1 ft² = 0.0929 m².

8.7.2.2.2 In any case, the maximum area of coverage of a sprinkler shall not exceed 196 ft² (18.2 m²).

8.7.3 Sprinkler Spacing (Standard Sidewall Spray Sprinklers).

8.7.3.1 Maximum Distance Between Sprinklers.

8.7.3.1.1 The maximum distance permitted between sidewall spray sprinklers shall be based on the centerline distance between sprinklers on the branch line.

8.7.3.1.2 The maximum distance between sidewall spray sprinklers or to a wall shall be measured along the slope of the ceiling.

8.7.3.1.3 Where sidewall spray sprinklers are installed along the length of a single wall of rooms or bays, they shall be spaced in accordance with the maximum spacing provisions of Table 8.7.2.2.1.

8.7.3.1.4 Sidewall spray sprinklers shall not be installed back-to-back without being separated by a continuous lintel or soffit.

8.7.3.1.5 Where sidewall spray sprinklers are installed on two opposite walls or sides of bays, the maximum width of the room or bay shall be permitted to be up to 24 ft (7.32 m) for light hazard occupancy or 20 ft (6.1 m) for ordinary hazard occupancy, with spacing as required by Table 8.7.2.2.1.

8.7.3.1.6 Sidewall spray sprinklers shall be permitted to be installed on opposing or adjacent walls, provided no sprinkler is located within the maximum protection area of another sprinkler.

8.7.3.1.7 Where sidewall standard spray sprinklers are installed to protect areas below overhead doors within ordinary hazard occupancy spaces or rooms, protection area and maximum sprinkler spacing for light hazard as specified in Table 8.7.2.2.1 shall be permitted

under the overhead doors.

8.7.3.2 Maximum Distance from Walls. The distance from sprinklers to the end walls shall not exceed one-half of the allowable distance permitted between sprinklers as indicated in Table 8.7.2.2.1.

8.7.3.3 Minimum Distance from Walls.

8.7.3.3.1 Sprinklers shall be located a minimum of 4 in. (102 mm) from an end wall.

8.7.3.3.2 The distance from the wall to the sprinkler shall be measured perpendicular to the wall.

8.7.3.4 Minimum Distance Between Sprinklers. Sprinklers shall be spaced not less than 6 ft (1.8 m) on center.

8.7.4 Deflector Position from Ceilings and Walls (Standard Sidewall Spray Sprinklers).

8.7.4.1 Distance Below Ceilings and from Walls.

8.7.4.1.1 Ceilings.

8.7.4.1.1.1 Unless the requirements of 8.7.4.1.1.2 are met, sidewall sprinkler deflectors shall be located not more than 6 in. (152 mm) or less than 4 in. (102 mm) from ceilings.

8.7.4.1.1.2 Horizontal sidewall sprinklers shall be permitted to be located in a zone 6 in. to 12 in. (152 mm to 305 mm) or 12 in. to 18 in. (305 mm to 457 mm) below noncombustible and limited-combustible ceilings where listed for such use.

8.7.4.1.2 Walls.

8.7.4.1.2.1 Vertical sidewall sprinkler deflectors shall be located not more than 6 in. (152 mm) or less than 4 in. (102 mm) from the wall they are projecting from.

8.7.4.1.2.2 Horizontal sidewall sprinkler deflectors shall be located no more than 6 in. (152 mm), and are permitted to be located with their deflectors less than 4 in. (102 mm), from the wall on which they are mounted.

8.7.4.1.3 Lintels and Soffits.

8.7.4.1.3.1 Where soffits used for the installation of sidewall sprinklers exceed 8 in. (203 mm) in width or projection from the wall, additional sprinklers shall be installed below the soffit.

8.7.4.1.3.2* Where soffits used for the installation of sidewall sprinklers are less than or equal to 8 in. (203 mm) in width or projection from the wall, additional sprinklers shall not be required below the soffit when the sidewall sprinkler on the soffit is within 4 in. (102 mm) from the bottom of the soffit.

8.7.4.1.3.3* A sidewall sprinkler shall be permitted to be installed under a soffit when both the minimum distance from the sprinkler deflector to the bottom of the soffit and maximum distance from the sprinkler deflector to the high ceiling is maintained.

8.7.4.2 Deflector Orientation.

8.7.4.2.1 Deflectors of sprinklers shall be aligned parallel to ceilings or roofs.

8.7.4.2.2 Sidewall sprinklers, where installed under a sloped ceiling with a slope exceeding 2 in 12, shall be located at the high point of the slope and positioned to discharge downward along the slope.

8.7.5 Obstructions to Sprinkler Discharge (Standard Sidewall Spray Sprinklers).

8.7.5.1 Performance Objective.

8.7.5.1.1 Sprinklers shall be located so as to minimize obstructions to discharge as defined in 8.5.5.2 and 8.5.5.3, or additional sprinklers shall be provided to ensure adequate coverage of the hazard.

8.7.5.1.2 Sidewall sprinklers shall be installed no closer than 4 ft (1.2 m) from light fixtures or similar obstructions.

8.7.5.1.3 The distance between light fixtures or similar obstructions located more than 4 ft (1.2 m) from the sprinkler shall be in conformity with Table 8.7.5.1.3 and Figure 8.7.5.1.3.

Table 8.7.5.1.3 Positioning of Sprinklers to Avoid Obstructions (Standard Sidewall Spray Sprinklers)

Distance from Sidewall Sprinkler to Side of Obstruction (A)	Maximum Allowable Distance of Deflector Above Bottom of Obstruction (in.) (B)
Less than 4 ft	Not allowed
4 ft to less than 5 ft	1
5 ft to less than 5 ft 6 in.	2
5 ft 6 in. to less than 6 ft	3
6 ft to less than 6 ft 6 in.	4
6 ft 6 in. to less than 7 ft	6
7 ft to less than 7 ft 6 in.	7
7 ft 6 in. to less than 8 ft	9
8 ft to less than 8 ft 6 in.	11
8 ft 6 in. or greater	14

For SI units, 1 in. = 25.4 mm; 1 ft = 0.3048 m.

Note: For (A) and (B), refer to Figure 8.7.5.1.3.

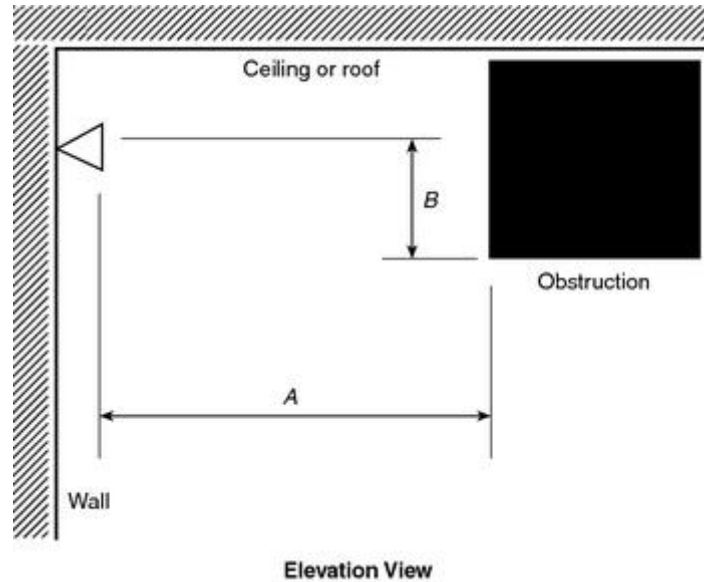

FIGURE 8.7.5.1.3 Positioning of Sprinklers to Avoid Obstructions (Standard Sidewall Spray Sprinklers).

8.7.5.1.4 Obstructions projecting from the same wall as the one on which the sidewall sprinkler is mounted shall be in accordance with Table 8.7.5.1.4 and Figure 8.7.5.1.4.

Table 8.7.5.1.4 Positioning of Sprinklers to Avoid Obstructions Along the Wall (Standard Sidewall Spray Sprinklers)

Distance from Sidewall Sprinkler to Side of Obstruction (<i>A</i>)	Maximum Allowable Distance of Deflector Above Bottom of Obstruction (in.) (<i>B</i>)
Less than 6 in.	1
6 in. to less than 1 ft	2
1 ft to less than 1 ft 6 in.	3
1 ft 6 in. to less than 2 ft	4½
2 ft to less than 2 ft 6 in.	5¾
2 ft 6 in. to less than 3 ft	7
3 ft to less than 3 ft 6 in.	8
3 ft 6 in. to less than 4 ft	9¼
4 ft to less than 4 ft 6 in.	10
4 ft 6 in. to less than 5 ft	11½
5 ft to less than 5 ft 6 in.	12¾
5 ft 6 in. to less than 6 ft	14
6 ft to less than 6 ft 6 in.	15
6 ft 6 in. to less than 7 ft	16¼
7 ft to less than 7 ft 6 in.	17½

For SI units, 1 in. = 25.4 mm; 1 ft = 0.3048 m.

Note: For (*A*) and (*B*), refer to Figure 8.7.5.1.4.

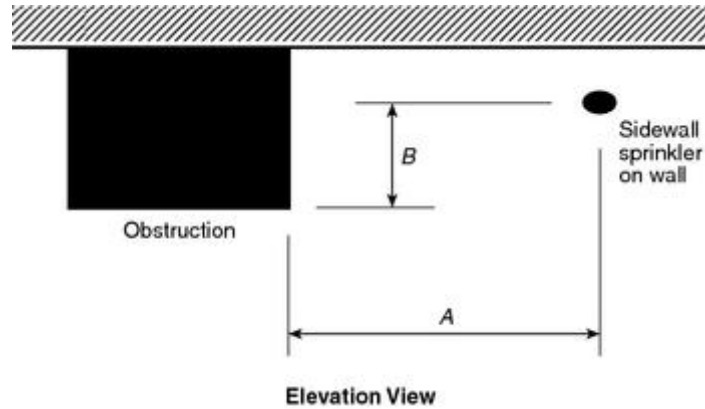

FIGURE 8.7.5.1.4 Positioning of Sprinklers to Avoid Obstructions Along the Wall (Standard Sidewall Spray Sprinklers).

8.7.5.1.5 Sprinklers shall be permitted to be spaced on opposite sides of obstructions less than 4 ft (1.22 m) in width where the distance from the centerline of the obstruction to the sprinklers does not exceed one-half the allowable distance between sprinklers.

8.7.5.2 Obstructions to Sprinkler Discharge Pattern Development.

8.7.5.2.1 General.

8.7.5.2.1.1 Continuous or noncontinuous obstructions less than or equal to 18 in. (457 mm) below the sprinkler deflector that prevent the pattern from fully developing shall comply with this section.

8.7.5.2.1.2 Regardless of the rules of this section, solid continuous obstructions shall meet the requirements of 8.7.5.1.2 and 8.7.5.1.3.

8.7.5.2.1.3* Unless the requirements of 8.7.5.2.1.4 or 8.7.5.2.1.5 are met, sprinklers shall be positioned away from obstructions a minimum distance of three times the maximum dimension of the obstruction (e.g., truss webs and chords, pipe, columns, and fixtures). The maximum clear distance required shall be 24 in. (609 mm) and shall be positioned in accordance with Figure 8.7.5.2.1.3 where obstructions are present.

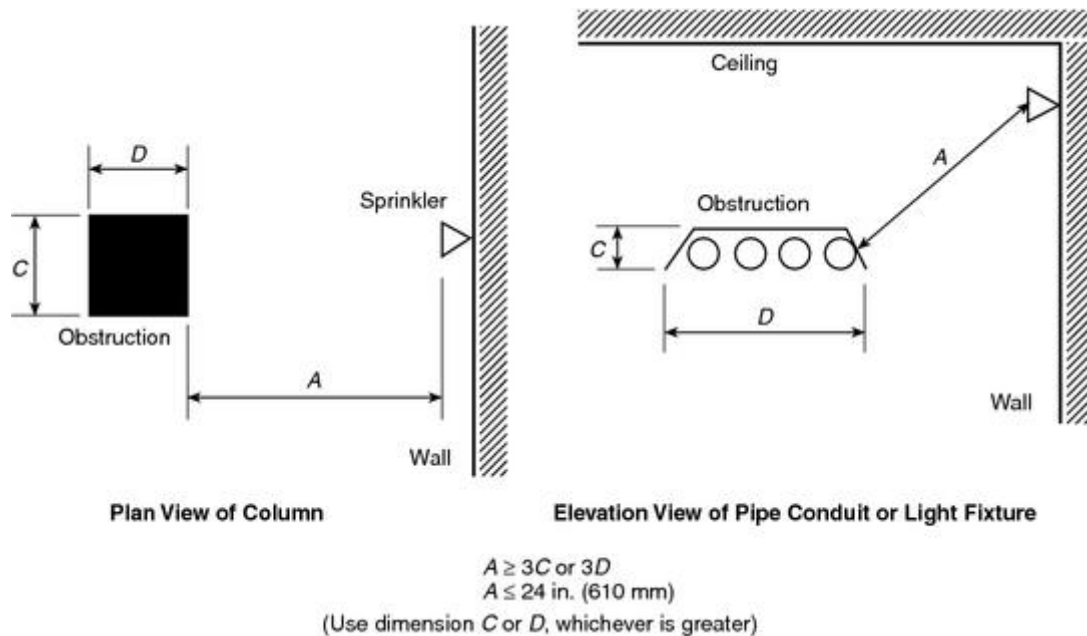

FIGURE 8.7.5.2.1.3 Minimum Distance from Obstruction (Standard Sidewall Spray Sprinkler)

8.7.5.2.1.4 The requirements of 8.7.5.2.1.3 shall not apply to sprinkler system piping less than 3 in. (80 mm) in diameter.

8.7.5.2.1.5 The requirements of 8.7.5.2.1.3 shall not apply where sprinklers are positioned with respect to obstructions in accordance with 8.7.5.1.2, 8.7.5.1.3, and 8.7.5.1.4.

8.7.5.2.2 Suspended or Floor-Mounted Vertical Obstructions. The distance from sprinklers to privacy curtains, free-standing partitions, room dividers, and similar obstructions in light hazard occupancies shall be in accordance with Table 8.7.5.2.2 and Figure 8.7.5.2.2.

Table 8.7.5.2.2 Suspended or Floor-Mounted Obstructions (Standard Sidewall Spray Sprinklers) in Light Hazard Occupancies Only

Horizontal Distance (A)	Minimum Vertical Distance Below Deflector (in.) (B)
6 in. or less	3
More than 6 in. to 9 in.	4
More than 9 in. to 12 in.	6
More than 12 in. to 15 in.	8
More than 15 in. to 18 in.	9½
More than 18 in. to 24 in.	12½
More than 24 in. to 30 in.	15½
More than 30 in.	18

For SI units, 1 in. = 25.4 mm.

Note: For (A) and (B), refer to Figure 8.7.5.2.2.

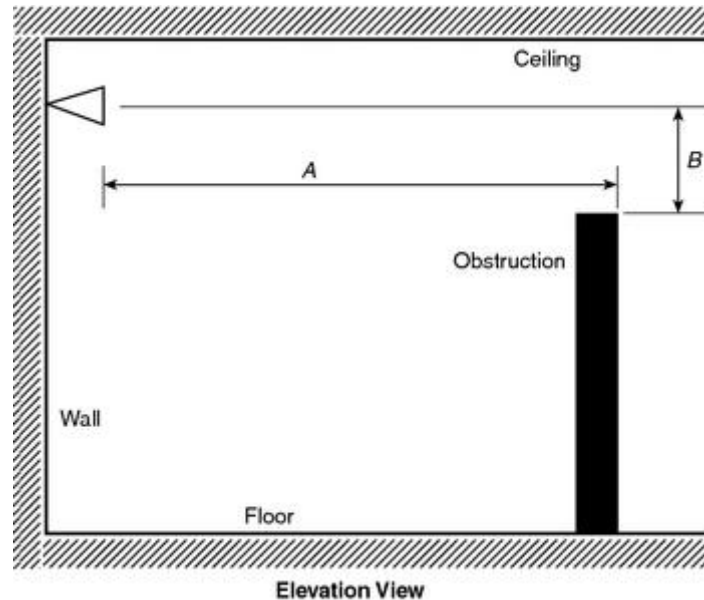

FIGURE 8.7.5.2.2 Suspended or Floor-Mounted Obstructions (Standard Sidewall Spray Sprinklers) in Light Hazard Occupancies Only.

8.7.5.2.2.1* In light hazard occupancies, privacy curtains that are supported by fabric mesh on ceiling track and have openings in the mesh equal to 70 percent or greater and extend a minimum of 22 in. (559 mm) from ceiling shall not be considered obstructions as shown in Figure 8.7.5.2.2.

8.7.5.3* Obstructions That Prevent Sprinkler Discharge from Reaching the Hazard.

8.7.5.3.1 Continuous or noncontinuous obstructions that interrupt the water discharge in a horizontal plane more than 18 in. (457 mm) below the sprinkler deflector in a manner to limit the distribution from reaching the protected hazard shall comply with this section.

8.7.5.3.2 Sprinklers shall be installed under fixed obstructions over 4 ft (1.2 m) wide such as ducts, decks, open grate flooring, cutting tables, and overhead doors.

8.7.5.3.3 Sprinklers shall not be required under obstructions that are not fixed in place such as conference tables.

8.7.6 Clearance to Storage (Standard Sidewall Spray Sprinklers). The clearance between the deflector and the top of storage shall be 18 in. (457 mm) or greater.

8.8 Extended Coverage Upright and Pendent Spray Sprinklers.

8.8.1 General. All requirements of Section 8.5 shall apply to extended coverage upright and pendent sprinklers except as modified in Section 8.8.

8.8.2 Protection Areas per Sprinkler (Extended Coverage Upright and Pendent Spray Sprinklers).

8.8.2.1* Determination of the Protection Area of Coverage.

8.8.2.1.1 The protection area of coverage (A_s) for extended coverage sprinklers shall be not less than that prescribed by the listing.

8.8.2.1.2 Listing dimensions shall be even-numbered square protection areas as shown in Table 8.8.2.1.2.

Table 8.8.2.1.2 Protection Areas and Maximum Spacing (Extended Coverage Upright Spray Sprinklers)

Construction Type	Light Hazard		Ordinary Hazard		Extra Hazard		H Pr
	Protection		Protection		Protection		
	Area (ft ²)	Spacing (ft)	Area (ft ²)	Spacing (ft)	Area (ft ²)	Spacing (ft)	
Unobstructed	400	20	400	20	—	—	
	324	18	324	18	—	—	
	256	16	256	16	—	—	
	—	—	196	14	196	14	
	—	—	144	12	144	15	
Obstructed noncombustible (when specifically listed for such use)	400	20	400	20	—	—	
	324	18	324	18	—	—	
	256	16	256	16	—	—	
	—	—	196	14	196	14	
	—	—	144	12	144	15	
Obstructed combustible	N/A	N/A	N/A	N/A	N/A	N/A	

For SI units, 1 ft = 0.3048 m; 1 ft² = 0.0929 m².

8.8.2.1.3 Determination of the protection area of coverage and sprinkler spacing for sprinklers listed for extended coverage extra hazard or high-piled storage shall be permitted to be spaced in accordance with the requirements of 8.5.2 and 8.5.3 and shall not exceed 14 ft (4.3 m) maximum spacing and 196 ft² (18.2 m²) maximum area per sprinkler.

8.8.2.2 Maximum Protection Area of Coverage.

8.8.2.2.1* The maximum allowable area of coverage for a sprinkler (A_s) shall be in accordance with the value indicated in Table 8.8.2.1.2.

8.8.2.2.2 In any case, the maximum area of coverage of a sprinkler shall not exceed 400 ft² (37.2 m²).

8.8.3 Sprinkler Spacing (Extended Coverage Upright and Pendent Spray Sprinklers).

8.8.3.1 Maximum Distance Between Sprinklers.

8.8.3.1.1 The maximum distance permitted between sprinklers shall be based on the centerline distance between sprinklers on the branch line or on adjacent branch lines.

8.8.3.1.2 The maximum distance shall be measured along the slope of the ceiling.

8.8.3.1.3 The maximum distance permitted between sprinklers shall comply with Table

8.8.2.1.2.

8.8.3.2 Maximum Distance from Walls.

8.8.3.2.1 The distance from sprinklers to walls shall not exceed one-half of the allowable distance permitted between sprinklers as indicated in Table 8.8.2.1.2.

8.8.3.2.2 The distance from the wall to the sprinkler shall be measured perpendicular to the wall.

8.8.3.2.3 Where walls are angled or irregular, the maximum horizontal distance between a sprinkler and any point of floor area protected by that sprinkler shall not exceed 0.75 times the allowable distance permitted between sprinklers.

8.8.3.3 Minimum Distance from Walls. Sprinklers shall be located a minimum of 4 in. (102 mm) from a wall unless listed for distances less than 4 in. (102 mm).

8.8.3.4 Minimum Distance Between Sprinklers.

8.8.3.4.1 Unless the requirements of 8.8.3.4.2 are met, sprinklers shall be spaced not less than 8 ft (2.4 m) on center.

8.8.3.4.2 Sprinklers shall be permitted to be placed less than 8 ft (2.4 m) on center where the following conditions are satisfied:

- (1) Baffles shall be installed and located midway between sprinklers and arranged to protect the actuating elements.
- (2) Baffles shall be of noncombustible or limited-combustible material that will stay in place before and during sprinkler operation.
- (3) Baffles shall be not less than 8 in. (203 mm) wide and 6 in. (152 mm) high.
- (4) The tops of baffles shall extend between 2 in. and 3 in. (51 mm and 76 mm) above the deflectors of upright sprinklers.
- (5) The bottoms of baffles shall extend downward to a level at least even with the deflectors of pendent sprinklers.

8.8.4 Deflector Position (Extended Coverage Upright and Pendent Spray Sprinklers).

8.8.4.1 Distance Below Ceilings.

8.8.4.1.1 Unobstructed Construction.

8.8.4.1.1.1 Under unobstructed construction, the distance between the sprinkler deflector and the ceiling shall be a minimum of 1 in. (25.4 mm) and a maximum of 12 in. (305 mm) throughout the area of coverage of the sprinkler.

8.8.4.1.1.2 The requirements of 8.8.4.1.1.1 shall not apply where ceiling-type sprinklers (concealed, recessed, and flush types) have the operating element above the ceiling and the deflector located nearer to the ceiling where installed in accordance with their listing.

8.8.4.1.1.3 The requirements of 8.8.4.1.1.1 shall not apply where sprinklers are listed for use under other ceiling construction features or for different distances where they shall be

permitted to be installed in accordance with their listing.

8.8.4.1.1.4 The requirements of 8.8.4.1.1.1 shall not apply for light and ordinary hazard occupancies with ceilings of noncombustible or limited combustible construction. Where there is a vertical change in ceiling elevation within the area of coverage of the sprinkler creating a distance of more than 36 in. (914 mm) between the upper ceiling and the sprinkler deflector, a vertical plane extending down from the ceiling at the change in elevation shall be considered a wall for the purpose of sprinkler spacing. Where the distance between the upper ceiling and the sprinkler deflector is less than or equal to 36 in. (914 mm), the sprinklers shall be permitted to be spaced as though the ceiling were flat, provided the obstruction rules and ceiling pocket rules are observed. (See Figure 8.8.4.1.1.4.)

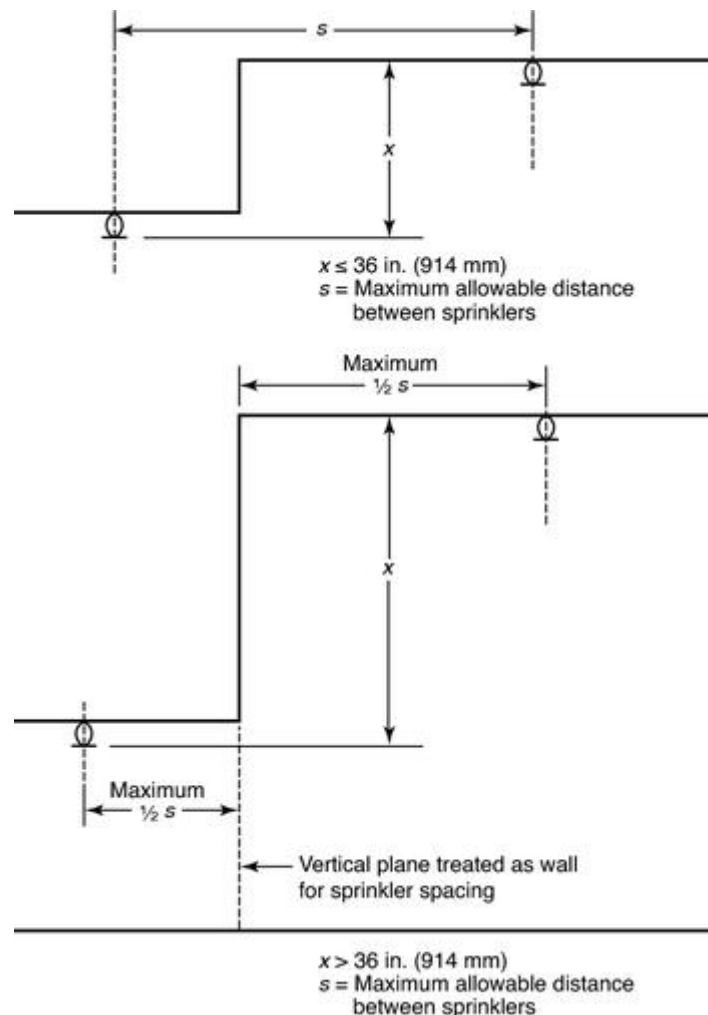

FIGURE 8.8.4.1.1.4 Vertical Changes in Ceiling Elevations.

8.8.4.1.2 Obstructed Construction. Under obstructed construction, the sprinkler deflector shall be located in accordance with one of the following arrangements:

- (1) Installed with the deflectors within the horizontal planes of 1 in. to 6 in. (25.4 mm to 152 mm) below the structural members and a maximum distance of 22 in. (559 mm) below the ceiling/roof deck.

- (2) Installed with the deflectors at or above the bottom of the structural member to a maximum of 22 in. (559 mm) below the ceiling/roof deck where the sprinkler is installed in conformance with 8.8.5.1.2.
- (3) Installed in each bay of obstructed construction, with the deflectors located a minimum of 1 in. (25.4 mm) and a maximum of 12 in. (305 mm) below the ceiling.
- (4) Where sprinklers are listed for use under other ceiling construction features or for different distances, they shall be permitted to be installed in accordance with their listing.

8.8.4.1.3* Peaked Roofs and Ceilings. Sprinklers under or near the peak of a roof or ceiling shall have deflectors located not more than 3 ft (0.9 m) vertically down from the peak in accordance with Figure 8.6.4.1.3.1(a) and Figure 8.6.4.1.3.1(b).

8.8.4.2 Deflector Orientation. Deflectors of sprinklers shall be aligned parallel to ceilings or roofs.

8.8.5 Obstructions to Sprinkler Discharge (Extended Coverage Upright and Pendent Spray Sprinklers).

8.8.5.1 Performance Objective.

8.8.5.1.1 Sprinklers shall be located so as to minimize obstructions to discharge as defined in 8.8.5.2 and 8.8.5.3, or additional sprinklers shall be provided to ensure adequate coverage of the hazard.

8.8.5.1.2 Sprinklers shall be arranged to comply with one of the following arrangements:

- (1) Sprinklers shall be in accordance with 8.5.5.2, Table 8.8.5.1.2, and Figure 8.8.5.1.2(a).
- (2) Sprinklers shall be permitted to be spaced on opposite sides of obstructions not exceeding 4 ft (1.2 m) in width provided the distance from the centerline of the obstruction to the sprinklers does not exceed one-half the allowable distance permitted between sprinklers.
- (3) Obstructions located against the wall and that are not over 30 in. (762 mm) in width shall be permitted to be protected in accordance with Figure 8.8.5.1.2(b).

Table 8.8.5.1.2 Position of Sprinklers to Avoid Obstructions to Discharge (Extended Coverage Upright and Pendent Spray Sprinklers)

Distance from Sprinklers to Side of Obstruction (<i>A</i>)	Maximum Allowable Distance of Deflector above Bottom of Obstruction (in.) (<i>B</i>)
Less than 1 ft	0
1 ft to less than 1 ft 6 in.	0
1 ft 6 in. to less than 2 ft	1
2 ft to less than 2 ft 6 in.	1
2 ft 6 in. to less than 3 ft	1

Table 8.8.5.1.2 Position of Sprinklers to Avoid Obstructions to Discharge (Extended Coverage Upright and Pendent Spray Sprinklers)

Distance from Sprinklers to Side of Obstruction (<i>A</i>)	Maximum Allowable Distance of Deflector above Bottom of Obstruction (in.) (<i>B</i>)
3 ft to less than 3 ft 6 in.	3
3 ft 6 in. to less than 4 ft	3
4 ft to less than 4 ft 6 in.	5
4 ft 6 in. to less than 5 ft	7
5 ft to less than 5 ft 6 in.	7
5 ft 6 in. to less than 6 ft	7
6 ft to less than 6 ft 6 in.	9
6 ft 6 in. to less than 7 ft	11
7 ft to less than 7 ft 6 in.	14
7 ft 6 in. to less than 8 ft	14
8 ft to less than 8 ft 6 in.	15
8 ft 6 in. to less than 9 ft	17
9 ft to less than 9 ft 6 in.	19
9 ft 6 in. to less than 10 ft	21

For SI units, 1 in. = 25.4 mm; 1 ft = 0.3048 m.

Note: For (*A*) and (*B*), refer to Figure 8.8.5.1.2(a).

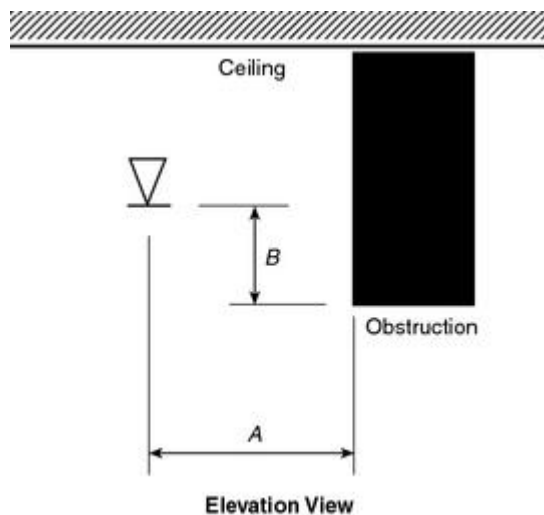

FIGURE 8.8.5.1.2(a) Position of Sprinklers to Avoid Obstructions to Discharge (Extended Coverage Upright and Pendent Spray Sprinklers).

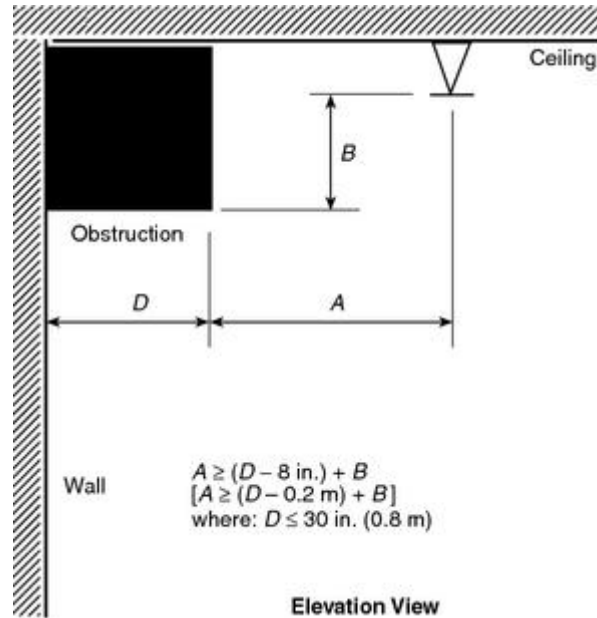

FIGURE 8.8.5.1.2(b) Obstructions Against Walls (Extended Coverage Upright and Pendent Spray Sprinklers).

8.8.5.2 Obstructions to Sprinkler Discharge Pattern Development.

8.8.5.2.1 General.

8.8.5.2.1.1 Continuous or noncontinuous obstructions less than or equal to 18 in. (457 mm) below the sprinkler deflector that prevent the pattern from fully developing shall comply with 8.8.5.2.

8.8.5.2.1.2 Regardless of the rules of this section, solid continuous obstructions shall meet the applicable requirements of 8.8.5.1.2.

8.8.5.2.1.3* Unless the requirements of 8.8.5.2.1.4 through 8.8.5.2.1.7 are met, sprinklers shall be positioned away from obstructions a minimum distance of four times the maximum dimension of the obstruction (e.g., truss webs and chords, pipe, columns, and fixtures). The maximum clear distance required shall be 36 in. (914 mm) in accordance with Figure 8.8.5.2.1.3.

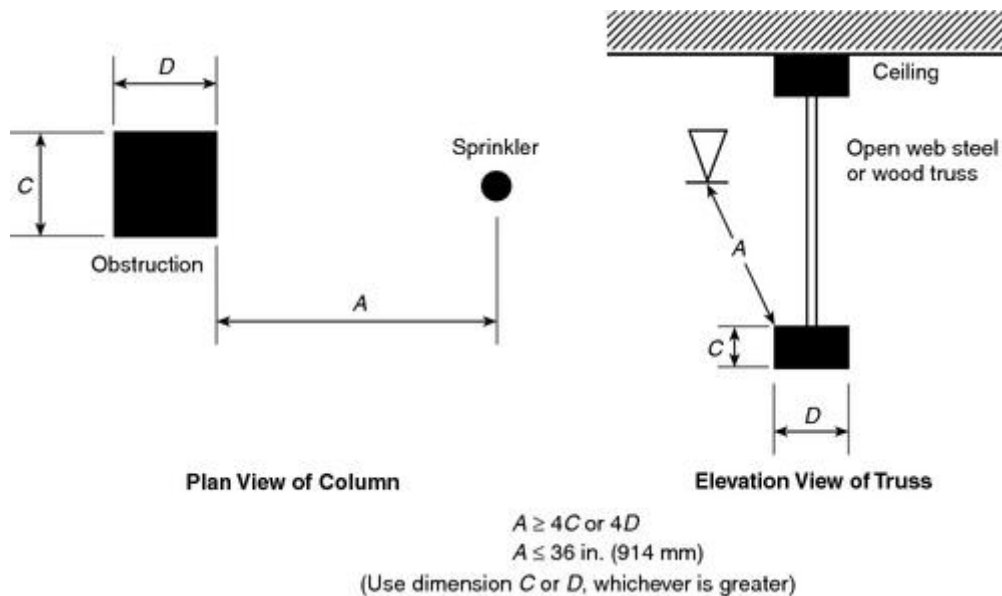

FIGURE 8.8.5.2.1.3 Minimum Distance from Obstruction (Extended Coverage Upright and Pendent Spray Sprinklers).

8.8.5.2.1.4 Sprinklers shall be permitted to be spaced on opposite sides of the obstruction where the distance from the centerline of the obstruction to the sprinklers does not exceed one-half the allowable distance between sprinklers.

8.8.5.2.1.5 Sprinklers shall be permitted to be located one-half the distance between the obstructions where the obstruction consists of wood bar joists 20 in. (0.51 m) or greater apart, provided that the top and bottom chords of the wood bar joist are not greater than 4 in. (102 mm) (nominal) in width and bar members do not exceed 1 in. (25.4 mm) in width.

8.8.5.2.1.6 The requirements of 8.8.5.2.1.3 shall not apply to sprinkler system piping less than 3 in. (80 mm) in diameter.

8.8.5.2.1.7 The requirements of 8.8.5.2.1.3 shall not apply to sprinklers positioned with respect to obstructions in accordance with 8.8.5.1.2.

8.8.5.2.2 Suspended or Floor-Mounted Vertical Obstructions. The distance from sprinklers to privacy curtains, freestanding partitions, room dividers, and similar obstructions in light hazard occupancies shall be in accordance with Table 8.8.5.2.2 and Figure 8.8.5.2.2.

Table 8.8.5.2.2 Suspended or Floor-Mounted Obstructions (Extended Coverage Upright and Pendent Spray Sprinklers) in Light Hazard Occupancies Only

8.8.5.2.2 Suspended or Floor-Mounted Vertical Obstructions. The distance from sprinklers to privacy curtains, freestanding partitions, room dividers, and similar obstructions in light hazard occupancies shall be in accordance with Table 8.8.5.2.2 and Figure 8.8.5.2.2.

Table 8.8.5.2.2 Suspended or Floor-Mounted Obstructions (Extended Coverage Upright and Pendent Spray Sprinklers) in Light Hazard Occupancies Only

Horizontal Distance (A)	Minimum Vertical Distance Below Deflector (in.) (B)
6 in. or less	3
More than 6 in. to 9 in.	4
More than 9 in. to 12 in.	6
More than 12 in. to 15 in.	8
More than 15 in. to 18 in.	9½
More than 18 in. to 24 in.	12½
More than 24 in. to 30 in.	15½
More than 30 in.	18

For SI units, 1 in. = 25.4 mm.

Note: For (A) and (B), refer to Figure 8.8.5.2.2.

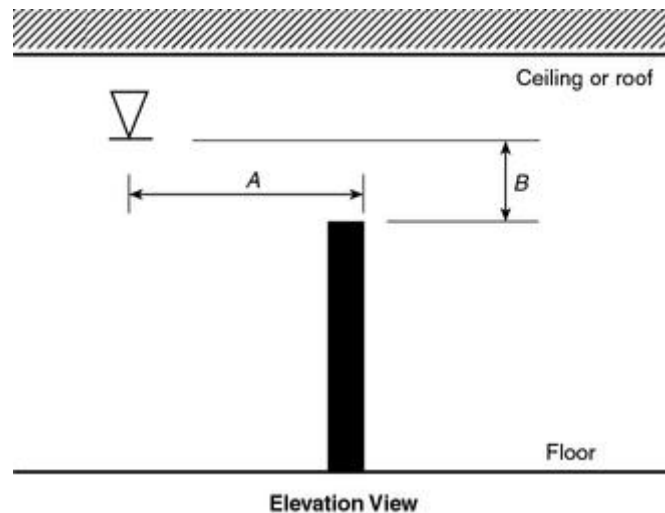

FIGURE 8.8.5.2.2 Suspended or Floor-Mounted Obstructions (Extended Coverage Upright and Pendent Spray Sprinklers) in Light Hazard Occupancies Only.

8.8.5.2.2.1 In light hazard occupancies, privacy curtains that are supported by fabric mesh on ceiling track and have openings in the mesh equal to 70 percent or greater and extend a

minimum of 22 in. (559 mm) from ceiling shall not be considered obstructions as shown in 8.8.5.2.2.

8.8.5.3* Obstructions That Prevent Sprinkler Discharge from Reaching the Hazard.

8.8.5.3.1 Continuous or noncontinuous obstructions that interrupt the water discharge in a horizontal plane more than 18 in. (457 mm) below the sprinkler deflector in a manner to limit the distribution from reaching the protected hazard shall comply with 8.8.5.3.

8.8.5.3.2 Sprinklers shall be installed under fixed obstructions over 4 ft (1.2 m) wide such as ducts, decks, open grate flooring, cutting tables, and overhead doors.

8.8.5.3.3 Sprinklers shall not be required under obstructions that are not fixed in place such as conference tables.

8.8.5.3.4 Sprinklers installed under open gratings shall be of the intermediate level/rack storage type or otherwise shielded from the discharge of overhead sprinklers.

8.8.6 Clearance to Storage (Extended Coverage Upright and Pendent Spray Sprinklers).

8.8.6.1 The clearance between the deflector and the top of storage shall be 18 in. (457 mm) or greater.

8.8.6.2 Where other standards specify greater clearance to storage minimums, they shall be followed.

8.8.7 Ceiling Pockets.

8.8.7.1 Sprinklers shall be required in all ceiling pockets.

8.8.7.2 The requirements of 8.8.7.1 shall not apply where all of the following are met:

- (1) The total volume of the unprotected ceiling pocket does not exceed 1000 ft³ (28.3 m³).
- (2) The depth of the unprotected pocket does not exceed 36 in. (914 mm).
- (3) The entire floor under the unprotected ceiling pocket is protected by the sprinklers at the lower ceiling elevation.
- (4) Each unprotected ceiling pocket is separated from any adjacent unprotected ceiling pocket by a minimum 10 ft (3.05 m) horizontal distance.
- (5) The unprotected ceiling pocket is constructed of noncombustible or limited combustible construction.
- (6) Skylights not exceeding 32 ft² (3 m²) shall be permitted to have a plastic cover.
- (7) Quick-response sprinklers are utilized throughout the compartment.

8.9 Extended Coverage Sidewall Spray Sprinklers.

8.9.1 General. All requirements of Section 8.5 shall apply to extended coverage sidewall spray sprinklers except as modified in Section 8.9.

8.9.2 Protection Areas per Sprinkler (Extended Coverage Sidewall Spray Sprinklers).

8.9.2.1* Determination of the Protection Area of Coverage.

8.9.2.1.1 The protection area of coverage per sprinkler (A_s) for extended coverage sidewall sprinklers shall be not less than that prescribed by the listing.

8.9.2.1.2 Listing dimensions shall be in 2 ft (0.61 m) increments up to 28 ft (8.5 m).

8.9.2.2 Maximum Protection Area of Coverage.

8.9.2.2.1 The maximum allowable protection area of coverage for a sprinkler (A_s) shall be in accordance with the value indicated in Table 8.9.2.2.1.

Table 8.9.2.2.1 Protection Area and Maximum Spacing for Extended Coverage Sidewall Sprinklers

Construction Type	Light Hazard				Ordinary Hazard			
	Protection Area		Spacing		Protection Area		Spacing	
	ft ²	m ²	ft	m	ft ²	m ²	ft	m
Unobstructed, smooth, flat	400	37.2	28	8.5	400	37.2	24	7.3

8.9.2.2.2 In any case, the maximum area of coverage of a sprinkler shall not exceed 400 ft² (37.2 m²).

8.9.3 Sprinkler Spacing (Extended Coverage Sidewall Spray Sprinklers).

8.9.3.1 Maximum Distance Between Sprinklers.

8.9.3.1.1 The maximum distance permitted between sprinklers shall be based on the centerline distance between sprinklers on the branch line along the wall.

8.9.3.1.2 Where sprinklers are installed along the length of a single wall of rooms or bays, they shall be spaced in accordance with the maximum spacing provisions of Table 8.9.2.2.1.

8.9.3.1.3 Sidewall sprinklers shall not be installed back-to-back without being separated by a continuous lintel, soffit, or baffle.

8.9.3.1.4 Sidewall sprinklers shall be permitted to be installed on opposing or adjacent walls, provided no sprinkler is located within the maximum protection area of another sprinkler.

8.9.3.2 **Maximum Distance from Walls.** The distance from sprinklers to the end walls shall not exceed one-half of the allowable distance permitted between sprinklers as indicated in Table 8.9.2.2.1.

8.9.3.3 Minimum Distance from Walls.

8.9.3.3.1 Sprinklers shall be located a minimum of 4 in. (102 mm) from an end wall.

8.9.3.3.2 The distance from the wall to the sprinkler shall be measured perpendicular to the wall.

8.9.3.4 Minimum Distance Between Sprinklers. No sprinklers shall be located within the maximum protection area of any other sprinkler.

8.9.4 Deflector Position from Ceilings and Walls (Extended Coverage Sidewall Spray Sprinklers).

8.9.4.1 Distance Below Ceilings and from Walls to Which Sprinklers Are Mounted.

8.9.4.1.1 Ceilings.

8.9.4.1.1.1 Unless the requirements of 8.9.4.1.1.2 are met, sidewall sprinkler deflectors shall be located not more than 6 in. (152 mm) nor less than 4 in. (102 mm) from ceilings.

8.9.4.1.1.2 Horizontal sidewall sprinklers shall be permitted to be located in a zone 6 in. to 12 in. (152 mm to 305 mm) or 12 in. to 18 in. (305 mm to 457 mm) below noncombustible or limited-combustible ceilings where listed for such use.

8.9.4.1.2 Walls.

8.9.4.1.2.1 Sidewall sprinkler deflectors shall be located not more than 6 in. (152 mm) or less than 4 in. (102 mm) from walls on which they are mounted.

8.9.4.1.2.2 Horizontal sidewall sprinklers shall be permitted to be located with their deflectors less than 4 in. (102 mm) from the wall on which they are mounted.

8.9.4.1.3 Lintels and Soffits.

8.9.4.1.3.1* Where soffits used for the installation of sidewall sprinklers are less than or equal to 8 in. (203 mm) in width or projection from the wall, additional sprinklers shall not be required below the soffit when the sidewall sprinkler on the soffit is within 4 in. (102 mm) from the bottom of the soffit.

8.9.4.1.3.2* A sidewall sprinkler shall be permitted to be installed under a soffit when both the minimum distance from the sprinkler deflector to the bottom of the soffit and the maximum distance from the sprinkler deflector to the high ceiling are maintained.

8.9.4.1.4* Soffits and Cabinets in Residential Areas/Occupancies. Where soffits are used for the installation of sidewall sprinklers, the sprinklers and soffits shall be installed in accordance with 8.9.4.1.4.1, 8.9.4.1.4.2, or 8.9.4.1.4.3.

8.9.4.1.4.1 Where soffits exceed more than 8 in. (203 mm) in width or projection from the wall, pendent sprinklers shall be installed under the soffit.

8.9.4.1.4.2 Sidewall sprinklers shall be permitted to be installed in the face of a soffit located directly over cabinets, without requiring additional sprinklers below the soffit or cabinets, where the soffit does not project horizontally more than 12 in. (305 mm) from the wall.

8.9.4.1.4.3 Where sidewall sprinklers are more than 3 ft (0.91 m) above the top of cabinets, the sprinkler shall be permitted to be installed on the wall above the cabinets where the cabinets are no greater than 12 in. (305 mm) from the wall.

8.9.4.2 Deflector Orientation.

8.9.4.2.1 Deflectors of sprinklers shall be aligned parallel to ceilings or roofs.

8.9.4.2.2 Sidewall sprinklers, where installed under a sloped ceiling with a slope exceeding 2 in 12, shall be located at the high point of the slope and positioned to discharge downward along the slope.

8.9.4.2.3 Sidewall sprinklers specifically listed for other ceiling configurations shall be permitted to be installed in accordance with the listing requirements.

8.9.5 Obstructions to Sprinkler Discharge (Extended Coverage Sidewall Spray Sprinklers).

8.9.5.1 Performance Objective.

8.9.5.1.1 Sprinklers shall be located so as to minimize obstructions to discharge as defined in 8.5.5.2 and 8.5.5.3, or additional sprinklers shall be provided to ensure adequate coverage of the hazard.

8.9.5.1.2 Sidewall sprinklers shall be installed no closer than 8 ft (2.4 m) from light fixtures or similar obstructions.

8.9.5.1.3 The distance between light fixtures or similar obstructions located more than 8 ft (2.4 m) from the sprinkler shall be in conformity with Table 8.9.5.1.3 and Figure 8.9.5.1.3.

Table 8.9.5.1.3 Positioning of Sprinklers to Avoid Obstructions (Extended Coverage Sidewall Sprinklers)

Distance from Sidewall Sprinkler to Side of Obstruction (<i>A</i>)	Maximum Allowable Distance of Deflector Above Bottom of Obstruction (in.) (<i>B</i>)
Less than 8 ft	Not allowed
8 ft to less than 10 ft	1
10 ft to less than 11 ft	2
11 ft to less than 12 ft	3
12 ft to less than 13 ft	4
13 ft to less than 14 ft	6
14 ft to less than 15 ft	7
15 ft to less than 16 ft	9
16 ft to less than 17 ft	11
17 ft or greater	14

For SI units, 1 in. = 25.4 mm; 1 ft = 0.3048 m.

Note: For (*A*) and (*B*), refer to Figure 8.9.5.1.3.

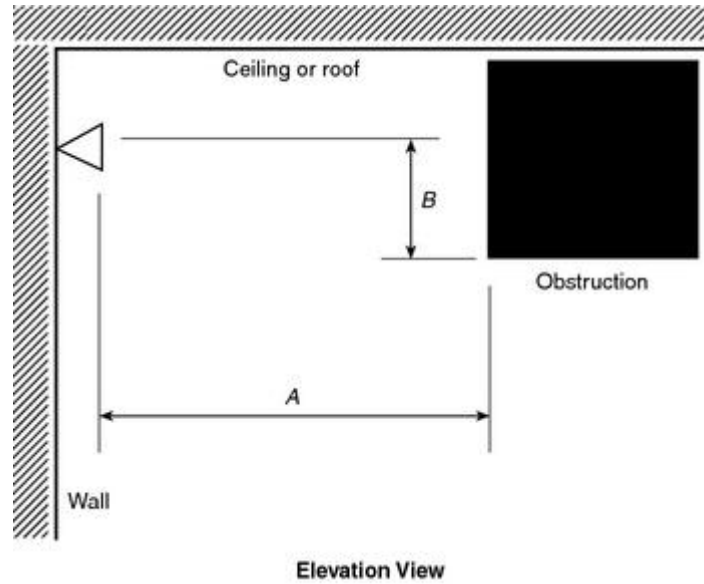

FIGURE 8.9.5.1.3 Positioning of Sprinklers to Avoid Obstructions (Extended Coverage Sidewall Sprinklers).

8.9.5.1.4 Continuous obstructions projecting from the same wall as the one on which the sidewall sprinkler is mounted shall be in accordance with Table 8.9.5.1.4 and Figure 8.9.5.1.4.

Table 8.9.5.1.4 Positioning of Sprinklers to Avoid Obstructions Along the Wall (Extended Coverage Sidewall Spray Sprinklers)

Distance from Sidewall Sprinkler to Side of Obstruction (<i>A</i>)	Maximum Allowable Distance of Deflector Above Bottom of Obstruction (in.) (<i>B</i>)
Less than 1 ft 6 in.	0
1 ft 6 in. to less than 3 ft	1
3 ft to less than 4 ft	3
4 ft to less than 4 ft 6 in.	5
4 ft 6 in. to less than 6 ft	7
6 ft to less than 6 ft 6 in.	9
6 ft 6 in. to less than 7 ft	11
7 ft to less than 7 ft 6 in.	14

For SI units, 1 in. = 25.4 mm; 1 ft = 0.3048 m.
 Note: For (*A*) and (*B*), refer to Figure 8.9.5.1.4.

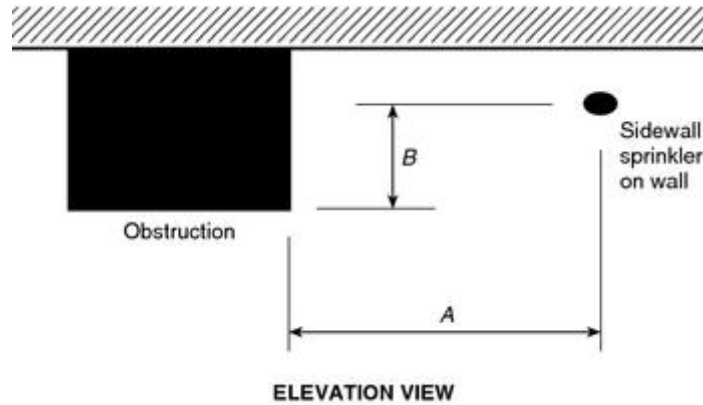

FIGURE 8.9.5.1.4 Positioning of Sprinklers to Avoid Obstructions Along the Wall (Extended Coverage Sidewall Spray Sprinklers).

8.9.5.1.5 Sprinklers shall be permitted to be spaced on opposite sides of obstructions less than 4 ft (1.22 m) in width where the distance from the centerline of the obstruction to the sprinklers does not exceed one-half the allowable distance between sprinklers.

8.9.5.2 Obstructions to Sprinkler Discharge Pattern Development.

8.9.5.2.1 General.

8.9.5.2.1.1 Continuous or noncontinuous obstructions less than or equal to 18 in. (457 mm) below the sprinkler deflector that prevent the pattern from fully developing shall comply with this section.

8.9.5.2.1.2 Regardless of the rules of this section, solid continuous obstructions shall meet the requirements of 8.9.5.1.2 and 8.9.5.1.3.

8.9.5.2.1.3* Unless the requirements of 8.9.5.2.1.4 through 8.9.5.2.1.6 are met, sprinklers shall be positioned away from obstructions a minimum distance of four times the maximum dimension of the obstruction (e.g., truss webs and chords, pipe, columns, and fixtures). The maximum clear distance required shall be 36 in. (914 mm) from the sprinkler.

8.9.5.2.1.4 Sidewall sprinklers shall be positioned in accordance with Figure 8.9.5.2.1.4 when obstructions are present.

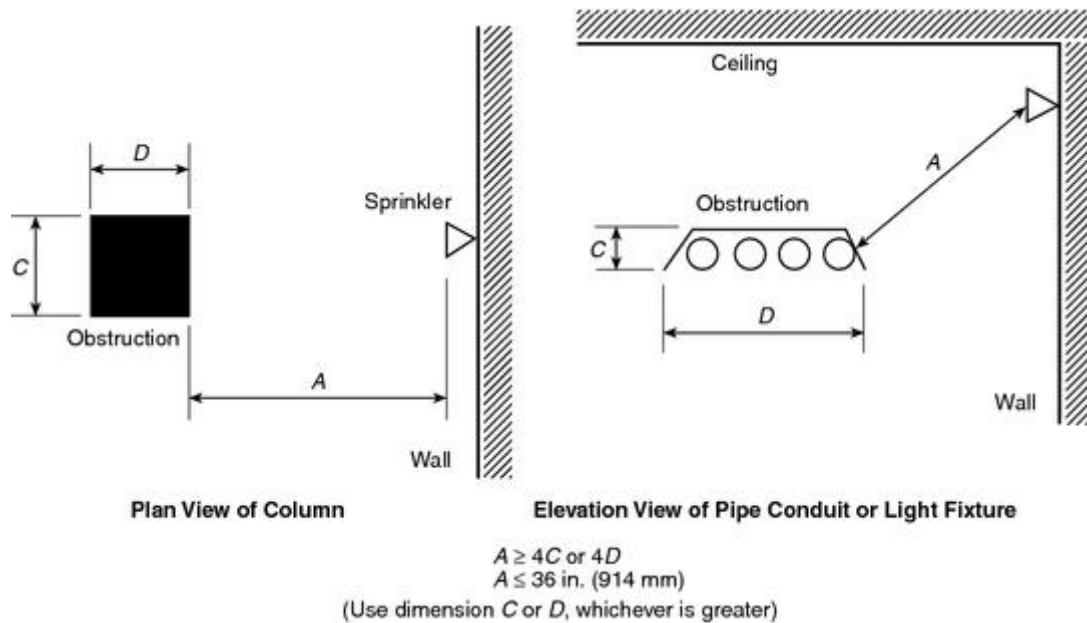

FIGURE 8.9.5.2.1.4 Minimum Distance from Obstruction (Extended Coverage Sidewall).

8.9.5.2.1.5 The requirements of 8.9.5.2.1.3 and 8.9.5.2.1.4 shall not apply where sprinklers are positioned with respect to obstructions in accordance with 8.9.5.1.2 and 8.9.5.1.3.

8.9.5.2.1.6 The requirements of 8.9.5.2.1.3 shall not apply to sprinkler system piping less than 3 in. (80 mm) in diameter.

8.9.5.2.2 Suspended or Floor-Mounted Vertical Obstructions. The distance from sprinklers to privacy curtains, freestanding partitions, room dividers, and similar obstructions in light hazard occupancies shall be in accordance with Table 8.9.5.2.2 and Figure 8.9.5.2.2.

Table 8.9.5.2.2 Suspended or Floor-Mounted Obstructions (Extended Coverage Sidewall Sprinklers) in Light Hazard Occupancies Only

Horizontal Distance (<i>A</i>)	Minimum Allowable Distance Below Deflector (in.) (<i>B</i>)
6 in. or less	3
More than 6 in. to 9 in.	4
More than 9 in. to 12 in.	6
More than 12 in. to 15 in.	8
More than 15 in. to 18 in.	9½
More than 18 in. to 24 in.	12½
More than 24 in. to 30 in.	15½
More than 30 in.	18

For SI units, 1 in. = 25.4 mm.

Note: For (*A*) and (*B*), refer to Figure 8.9.5.2.2.

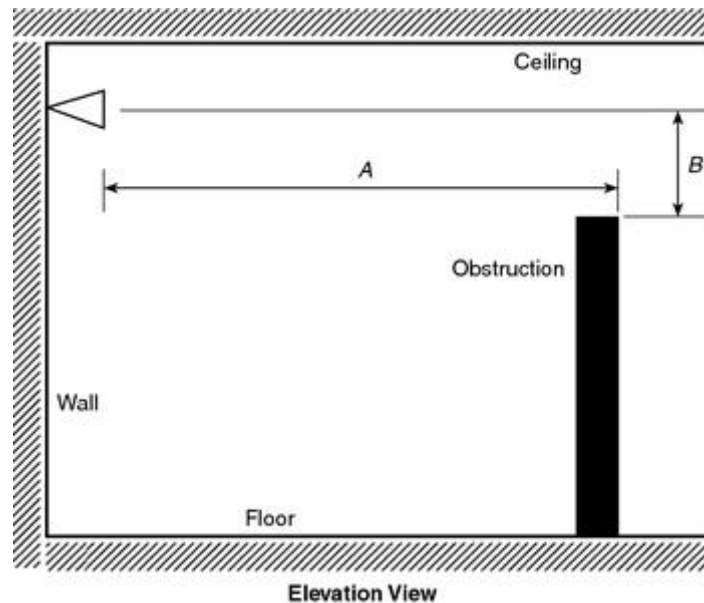

FIGURE 8.9.5.2.2 Suspended or Floor-Mounted Obstructions (Extended Coverage Sidewall Sprinklers) in Light Hazard Occupancies Only.

8.9.5.2.2.1* In light hazard occupancies, privacy curtains that are supported by fabric mesh on ceiling track and have openings in the mesh equal to 70 percent or greater and extend a minimum of 22 in. (559 mm) from the ceiling shall not be considered obstructions as shown in 8.9.5.2.2.

8.9.5.3* Obstructions That Prevent Sprinkler Discharge from Reaching the Hazard.

8.9.5.3.1 Continuous or noncontinuous obstructions that interrupt the water discharge in a horizontal plane more than 18 in. (457 mm) below the sprinkler deflector in a manner to limit the distribution from reaching the protected hazard shall comply with this section.

8.9.5.3.2 Sprinklers shall be installed under fixed obstructions over 4 ft (1.2 m) wide, such as ducts, decks, open grate flooring, cutting tables, and overhead doors.

8.9.5.3.3 Sprinklers shall not be required under obstructions that are not fixed in place, such as conference tables.

8.10 Residential Sprinklers.

8.10.1 Reserved

8.10.2* Listings.

8.10.2.1 Areas of coverage shall be in accordance with the manufacturer's listing.

8.10.2.2 Where residential sprinklers are installed on a slope greater than 2 in 12, they shall be listed for this application.

8.10.3 Distances Between Sprinklers.

8.10.3.1 Maximum distances between sprinklers shall be in accordance with the

manufacturer's listing.

8.10.3.2 The distance between the sprinkler and the wall shall not exceed half the maximum allowable distance between sprinklers per the manufacturer's listing.

8.10.3.3 The minimum distance between sprinklers within a compartment shall be 8 ft (2.44 m), unless the listing of the sprinkler requires a greater distance.

8.10.3.4 The maximum distance shall be measured along the slope of the ceiling as shown in Figure 8.10.3.4(a) and Figure 8.10.3.4(b).

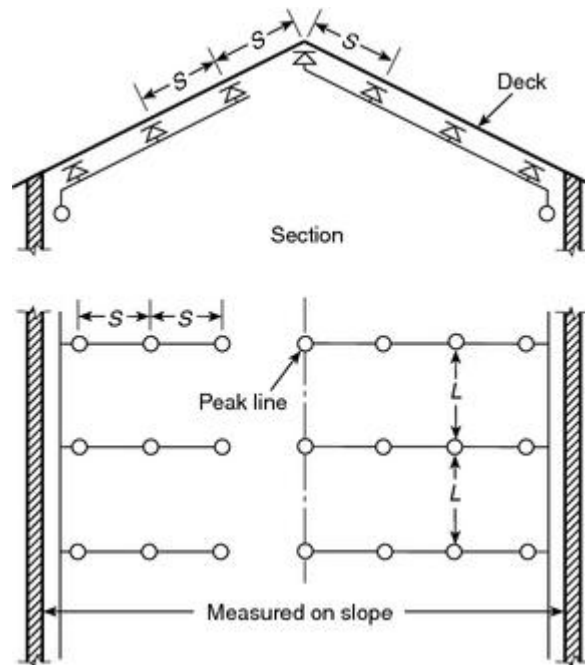

FIGURE 8.10.3.4(a) Maximum Distance Between Sprinklers with Sloped Ceilings — Arrangement A.

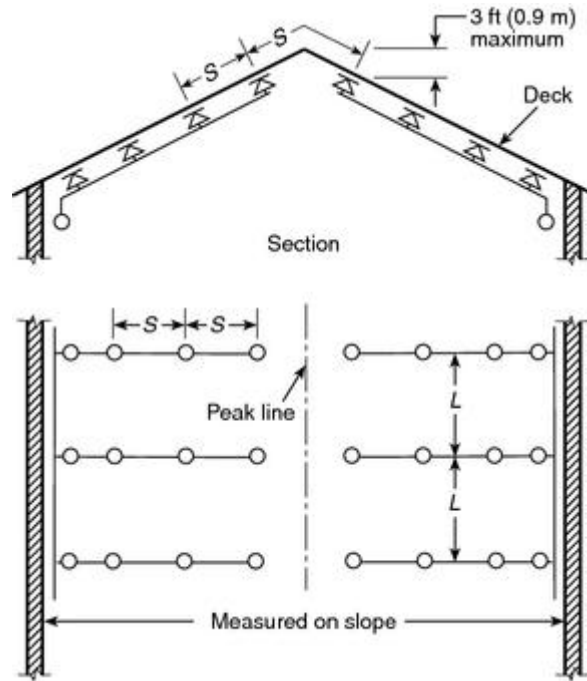

FIGURE 8.10.3.4(b) Maximum Distance Between Sprinklers with Sloped Ceilings — Arrangement B.

8.10.3.5 Where sprinklers are installed along sloped ceilings, the sprinklers shall maintain the minimum listed spacing, but no less than 8 ft (2.44 m), measured in the plan view from one sprinkler to another as shown in Figure 8.10.3.5(a) and Figure 8.10.3.5(b).

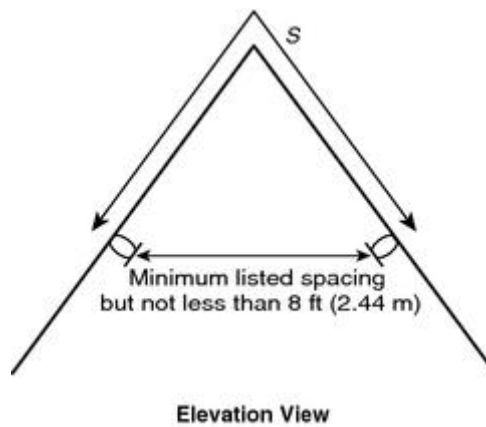

FIGURE 8.10.3.5(a) Minimum Distance Between Sprinklers with Sloped Ceilings — Arrangement A.

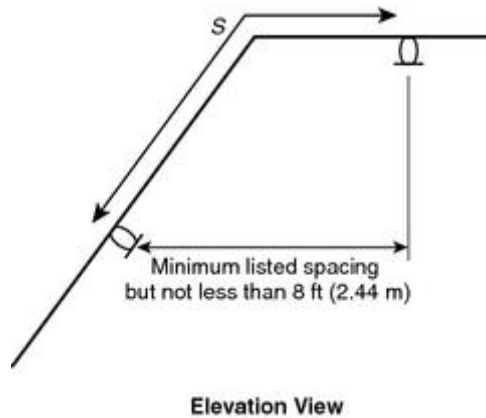

FIGURE 8.10.3.5(b) Minimum Distance Between Sprinklers with Sloped Ceilings — Arrangement B.

8.10.4 Deflector Position from Ceilings and Walls.

8.10.4.1 Pendent and upright sprinklers shall be positioned so that the deflectors are 1 in. to 4 in. (25 mm to 102 mm) from the ceiling unless the listing allows a greater distance.

8.10.4.2 Sidewall sprinklers shall be positioned so that the deflectors are within 4 in. to 6 in. (102 mm to 152 mm) from the ceiling unless the listing allows greater distances.

8.10.4.3 Where soffits used for the installation of sidewall sprinklers exceed 8 in. (203 mm) in width or projection from the wall, additional sprinklers shall be installed below the soffit.

8.10.5 Residential sprinklers installed in conformance with this standard shall follow the sprinkler obstruction rules of 8.10.6 or 8.10.7 as appropriate for their installation orientation (upright, pendent, or sidewall) and the obstruction criteria specified in the manufacturer's installation instructions.

8.10.6 Obstructions to Sprinkler Discharge (Residential Upright and Pendent Spray Sprinklers).

8.10.6.1 Performance Objective.

8.10.6.1.1 Sprinklers shall be located so as to minimize obstructions to discharge as defined in 8.10.6.2 and 8.10.6.3, or additional sprinklers shall be provided to ensure adequate coverage of the hazard.

8.10.6.1.2 Sprinklers shall be arranged to comply with one of the following arrangements:

- (1) Sprinklers shall be in accordance with 8.5.5.2, Table 8.10.6.1.2, and Figure 8.10.6.1.2(a).
- (2) Sprinklers shall be permitted to be spaced on opposite sides of obstructions not exceeding 4 ft (1.2 m) in width, provided the distance from the centerline of the obstruction to the sprinklers does not exceed one-half the allowable distance permitted between sprinklers.
- (3) Obstructions located against the wall and that are not over 30 in. (762 mm) in width

shall be permitted to be protected in accordance with Figure 8.10.6.1.2(b).

Table 8.10.6.1.2 Position of Sprinklers to Avoid Obstructions to Discharge (Residential Upright and Pendent Spray Sprinklers)

Distance from Sprinklers to Side of Obstruction (<i>A</i>)	Maximum Allowable Distance of Deflector Above Bottom of Obstruction (in.) (<i>B</i>)
Less than 1 ft	0
1 ft to less than 1 ft 6 in.	0
1 ft 6 in. to less than 2 ft	1
2 ft to less than 2 ft 6 in.	1
2 ft 6 in. to less than 3 ft	1
3 ft to less than 3 ft 6 in.	3
3 ft 6 in. to less than 4 ft	3
4 ft to less than 4 ft 6 in.	5
4 ft 6 in. to less than 5 ft	7
5 ft to less than 5 ft 6 in.	7
5 ft 6 in. to less than 6 ft	7
6 ft to less than 6 ft 6 in.	9
6 ft 6 in. to less than 7 ft	11
7 ft and greater	14

For SI units, 1 in. = 25.4 mm; 1 ft = 0.3048 m.

Note: For (*A*) and (*B*), refer to Figure 8.10.6.1.2(a).

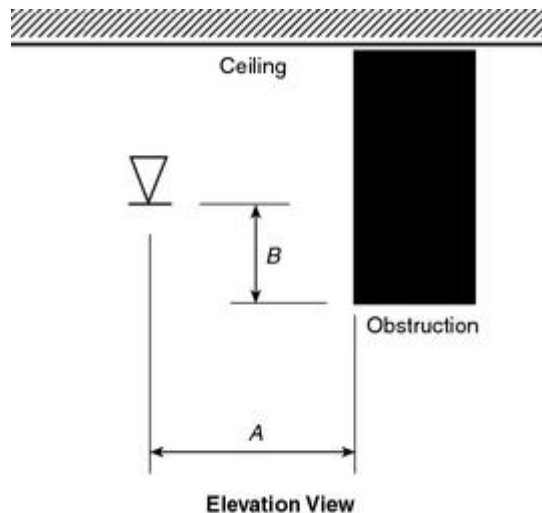

FIGURE 8.10.6.1.2(a) Position of Sprinklers to Avoid Obstructions to Discharge (Residential Upright and Pendent Spray Sprinklers).

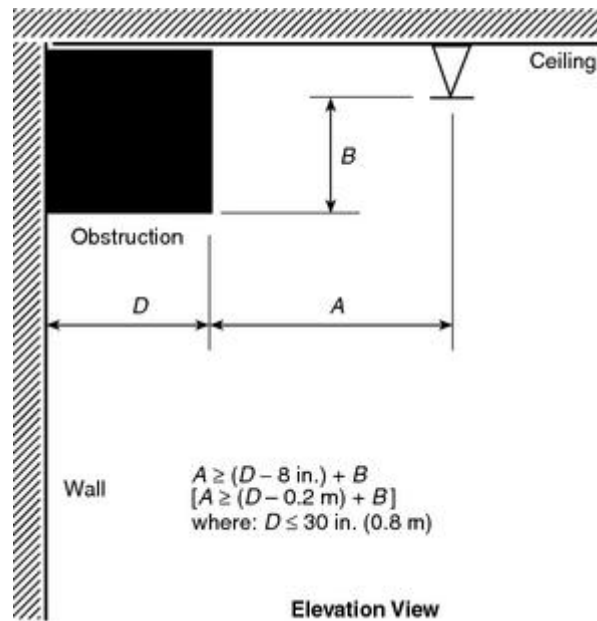

FIGURE 8.10.6.1.2(b) Obstructions Against Walls (Residential Upright and Pendent Spray Sprinklers).

8.10.6.2 Obstructions to Sprinkler Discharge Pattern Development.

8.10.6.2.1 General.

8.10.6.2.1.1 Continuous or noncontinuous obstructions less than or equal to 18 in. (457 mm) below the sprinkler deflector that prevent the pattern from fully developing shall comply with 8.10.6.2.

8.10.6.2.1.2 Regardless of the rules of this section, solid continuous obstructions shall meet the applicable requirements of 8.10.6.1.2.

8.10.6.2.1.3* Unless the requirements of 8.10.6.2.1.4 through 8.10.6.2.1.8 are met, sprinklers shall be positioned away from obstructions a minimum distance of four times the maximum dimension of the obstruction (e.g., truss webs and chords, pipe, columns, and fixtures). The maximum clear distance required shall be 36 in. (914 mm) in accordance with Figure 8.10.6.2.1.3.

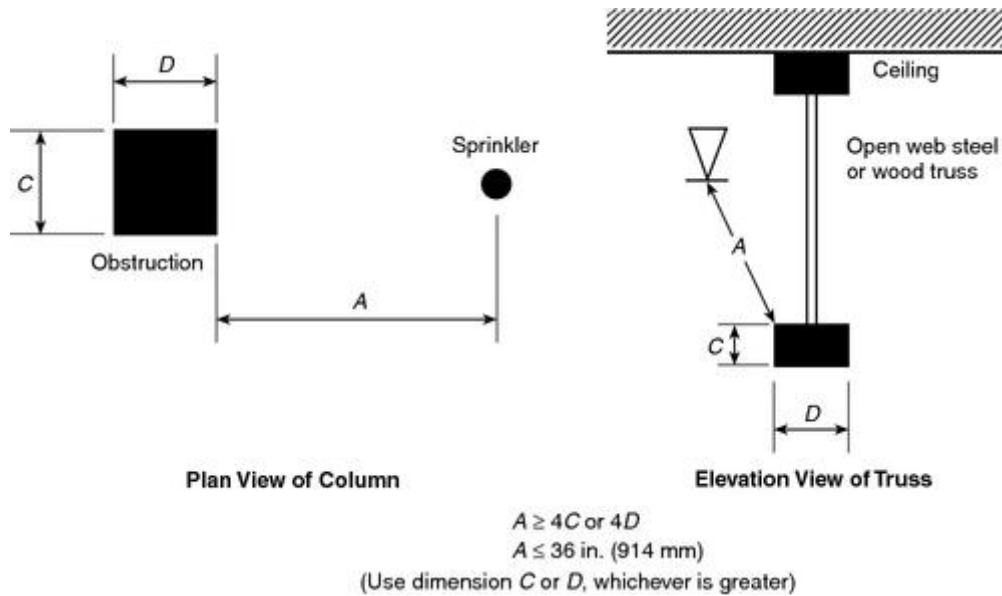

FIGURE 8.10.6.2.1.3 Minimum Distance from Obstruction (Residential Upright and Pendent Spray Sprinklers).

8.10.6.2.1.4 Sprinklers shall be permitted to be spaced on opposite sides of the obstruction where the distance from the centerline of the obstruction to the sprinklers does not exceed one-half the allowable distance between sprinklers.

8.10.6.2.1.5 Sprinklers shall be permitted to be located one-half the distance between the obstructions where the obstruction consists of open trusses 20 in. (0.51 m) or greater apart [24 in. (0.61 m) on center], provided that all truss members are not greater than 4 in. (102 mm) (nominal) in width and web members do not exceed 1 in. (25.4 mm) in width.

8.10.6.2.1.6 Sprinklers shall be permitted to be installed on the centerline of a truss or bar joist or directly above a beam provided that the truss chord or beam dimension is not more than 8 in. (203 mm) and the sprinkler deflector is located at least 6 in. (152 mm) above the structural member and where the sprinkler is positioned at a distance four times greater than the maximum dimension of the web members away from the web members.

8.10.6.2.1.7 The requirements of 8.10.6.2.1.3 shall not apply to sprinkler system piping less than 3 in. (80 mm) in diameter.

8.10.6.2.1.8 The requirements of 8.10.6.2.1.3 shall not apply to sprinklers positioned with respect to obstructions in accordance with 8.10.6.1.2.

8.10.6.2.2 Suspended or Floor-Mounted Vertical Obstructions. The distance from sprinklers to privacy curtains, free-standing partitions, room dividers, and similar obstructions in light hazard occupancies shall be in accordance with Table 8.10.6.2.2 and

8.10.6.2.1.7 The requirements of 8.10.6.2.1.3 shall not apply to sprinkler system piping less than 3 in. (80 mm) in diameter.

8.10.6.2.1.8 The requirements of 8.10.6.2.1.3 shall not apply to sprinklers positioned with respect to obstructions in accordance with 8.10.6.1.2.

8.10.6.2.2 Suspended or Floor-Mounted Vertical Obstructions. The distance from sprinklers to privacy curtains, free-standing partitions, room dividers, and similar obstructions in light hazard occupancies shall be in accordance with Table 8.10.6.2.2 and Figure 8.10.6.2.2.

Table 8.10.6.2.2 Suspended or Floor-Mounted Obstructions (Residential Upright and Pendent Spray Sprinklers) in Light Hazard Occupancies Only

Horizontal Distance (A)	Minimum Vertical Distance Below Deflector (in.) (B)
6 in. or less	3
More than 6 in. to 9 in.	4
More than 9 in. to 12 in.	6
More than 12 in. to 15 in.	8
More than 15 in. to 18 in.	9½
More than 18 in. to 24 in.	12½
More than 24 in. to 30 in.	15½
More than 30 in.	18

For SI units, 1 in. = 25.4 mm.

Note: For (A) and (B), refer to Figure 8.10.6.2.2.

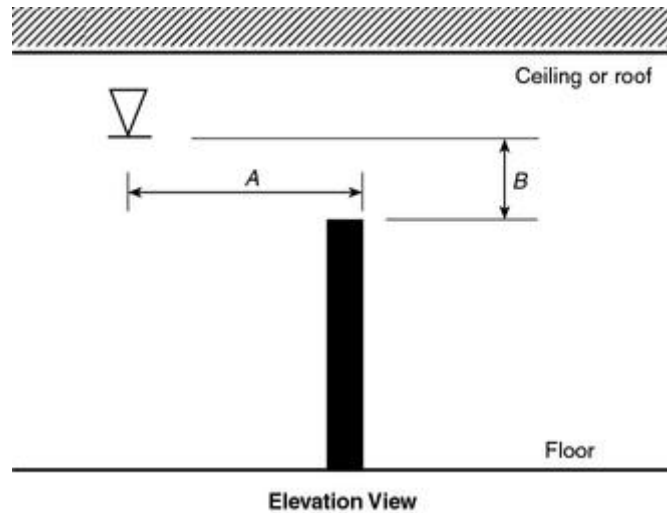

FIGURE 8.10.6.2.2 Suspended or Floor-Mounted Obstructions (Residential Upright and Pendent Spray Sprinklers) in Light Hazard Occupancies Only.

8.10.6.3* Obstructions That Prevent Sprinkler Discharge from Reaching the Hazard.

8.10.6.3.1 Continuous or noncontinuous obstructions that interrupt the water discharge in a horizontal plane more than 18 in. (457 mm) below the sprinkler deflector in a manner to limit the distribution from reaching the protected hazard shall comply with 8.10.6.3.

8.10.6.3.2 Sprinklers shall be installed under fixed obstructions over 4 ft (1.2 m) wide such as stairs and landings.

8.10.6.3.3 Sprinklers shall not be required under obstructions that are not fixed in place.

8.10.6.3.4 Sprinklers installed under open gratings shall be shielded from the discharge of overhead sprinklers.

8.10.7 Obstructions to Sprinkler Discharge (Residential Sidewall Sprinklers).

8.10.7.1 Performance Objective.

8.10.7.1.1 Sprinklers shall be located so as to minimize obstructions to discharge as defined in 8.5.5.2 and 8.5.5.3, or additional sprinklers shall be provided to ensure adequate coverage of the hazard.

8.10.7.1.2 Sidewall sprinklers shall be installed no closer than 8 ft (2.4 m) from light fixtures or similar obstructions.

8.10.7.1.3 The distance between light fixtures or similar obstructions located more than 8 ft (2.4 m) from the sprinkler shall be in conformity with Table 8.10.7.1.3 and Figure 8.10.7.1.3.

Table 8.10.7.1.3 Positioning of Sprinklers to Avoid Obstructions (Residential Sidewall Sprinklers)

or similar obstructions.

8.10.7.1.3 The distance between light fixtures or similar obstructions located more than 8 ft (2.4 m) from the sprinkler shall be in conformity with Table 8.10.7.1.3 and Figure 8.10.7.1.3.

Table 8.10.7.1.3 Positioning of Sprinklers to Avoid Obstructions (Residential Sidewall Sprinklers)

Distance from Sidewall Sprinkler to Side of Obstruction (A)	Maximum Allowable Distance of Deflector Above Bottom of Obstruction (in.) (B)
Less than 8 ft	Not Allowed
8 ft to less than 10 ft	1
10 ft to less than 11 ft	2
11 ft to less than 12 ft	3
12 ft to less than 13 ft	4
13 ft to less than 14 ft	6
14 ft to less than 15 ft	7
15 ft to less than 16 ft	9
16 ft to less than 17 ft	11
17 ft or greater	14

For SI units, 1 in. = 25.4 mm; 1 ft = 0.3048 m.
 Note: For (A) and (B), refer to Figure 8.10.7.1.3.

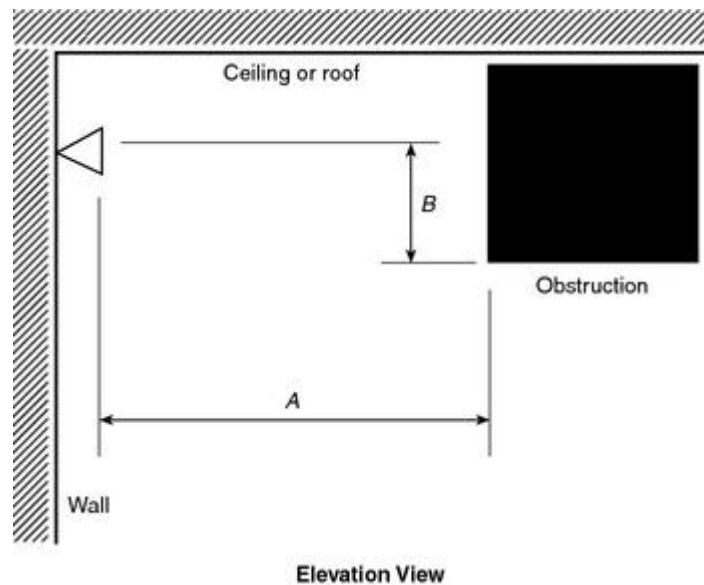

FIGURE 8.10.7.1.3 Positioning of Sprinklers to Avoid Obstructions (Residential Sidewall Sprinklers).

8.10.7.1.4 Obstructions projecting from the same wall as the one on which the sidewall

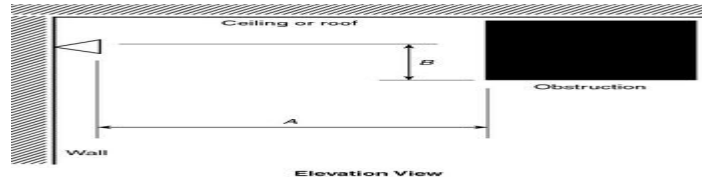

FIGURE 8.10.7.1.3 Positioning of Sprinklers to Avoid Obstructions (Residential Sidewall Sprinklers).

8.10.7.1.4 Obstructions projecting from the same wall as the one on which the sidewall sprinkler is mounted shall be in accordance with Table 8.10.7.1.4 and Figure 8.10.7.1.4.

Table 8.10.7.1.4 Positioning of Sprinklers to Avoid Obstructions Along the Wall (Residential Sidewall Sprinklers)

Distance from Sidewall Sprinkler to Side of Obstruction (<i>A</i>)	Maximum Allowable Distance of Deflector Above Bottom of Obstruction (in.) (<i>B</i>)
Less than 1 ft 6 in.	0
1 ft 6 in. to less than 3 ft	1
3 ft to less than 4 ft	3
4 ft to less than 4 ft 6 in.	5
4 ft 6 in. to less than 6 ft	7
6 ft to less than 6 ft 6 in.	9
6 ft 6 in. to less than 7 ft	11
7 ft to less than 7 ft 6 in.	14

For SI units, 1 in. = 25.4 mm; 1 ft = 0.3048 m.

Note: For (*A*) and (*B*), refer to Figure 8.10.7.1.4.

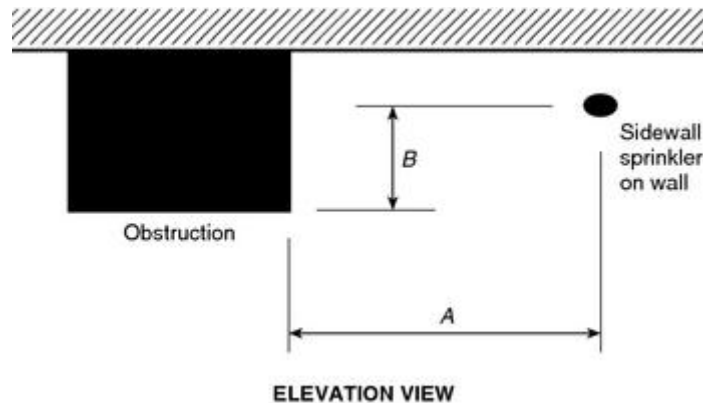

FIGURE 8.10.7.1.4 Positioning of Sprinklers to Avoid Obstructions Along the Wall (Residential Sidewall Sprinklers).

8.10.7.1.5* Soffits and Cabinets. Where soffits are used for the installation of sidewall sprinklers, the sprinklers and soffits shall be installed in accordance with 8.10.7.1.5.1, 8.10.7.1.5.2, or 8.10.7.1.5.3.

8.10.7.1.5.1 Where soffits exceed more than 8 in. (203 mm) in width or projection from the wall, pendent sprinklers shall be installed under the soffit.

8.10.7.1.5.2 Sidewall sprinklers shall be permitted to be installed in the face of a soffit located directly over cabinets, without requiring additional sprinklers below the soffit or cabinets, where the soffit does not project horizontally more than 12 in. (305 mm) from the wall.

8.10.7.1.5.3 Where sidewall sprinklers are more than 3 ft (914 mm) above the top of cabinets, the sprinkler shall be permitted to be installed on the wall above the cabinets where the cabinets are no greater than 12 in. (305 mm) from the wall.

8.10.7.2 Obstructions to Sprinkler Discharge Pattern Development.

8.10.7.2.1 General.

8.10.7.2.1.1 Continuous or noncontinuous obstructions less than or equal to 18 in. (457 mm) below the sprinkler deflector that prevent the pattern from fully developing shall comply with this section.

8.10.7.2.1.2 Regardless of the rules of this section, solid continuous obstructions shall meet the requirements of 8.10.7.1.2 and 8.10.7.1.3.

8.10.7.2.1.3* Unless the requirements of 8.10.7.2.1.4 through 8.10.7.2.1.7 are met, sprinklers shall be positioned away from obstructions a minimum distance of four times the maximum dimension of the obstruction. The maximum clear distance required shall be 36 in. (914 mm) from the sprinkler (e.g., truss webs and chords, pipe, columns, and fixtures).

8.10.7.2.1.4 Sidewall sprinklers shall be positioned in accordance with Figure 8.10.7.2.1.4 when obstructions are present.

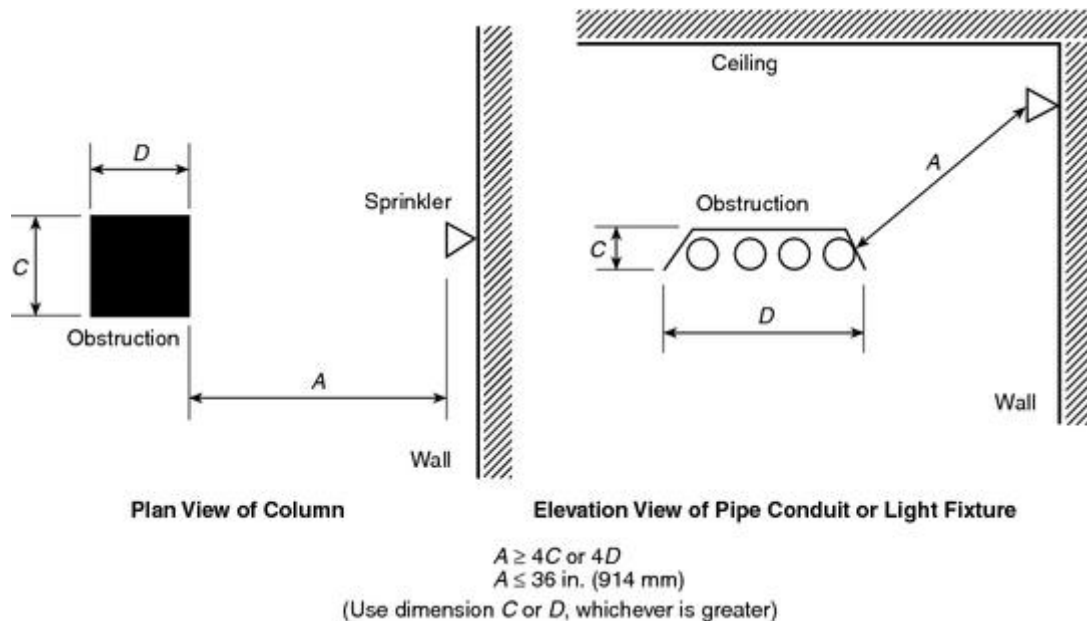

FIGURE 8.10.7.2.1.4 Minimum Distance from Obstruction (Residential Sidewall).

8.10.7.2.1.5 The requirements of 8.10.7.2.1.3 and 8.10.7.2.1.4 shall not apply where sprinklers are positioned with respect to obstructions in accordance with 8.10.7.1.2 and 8.10.7.1.3.

8.10.7.2.1.6 The requirements of 8.10.7.2.1.3 shall not apply to sprinkler system piping less than 3 in. (80 mm) in diameter.

8.10.7.2.1.7* Sprinklers shall be permitted to be placed without regard to the blades of a ceiling fan, provided the plan view of the fan is at least 50 percent open.

8.10.7.2.2 Suspended or Floor-Mounted Vertical Obstructions. The distance from sprinklers to privacy curtains, free-standing partitions, room dividers, and similar obstructions in light hazard occupancies shall be in accordance with Table 8.10.7.2.2 and Figure 8.10.7.2.2.

Table 8.10.7.2.2 Suspended or Floor-Mounted Obstructions (Residential Sidewall Sprinklers) in Light Hazard Occupancies Only

Horizontal Distance (<i>A</i>)	Minimum Allowable Distance Below Deflector (in.) (<i>B</i>)
6 in. or less	3
More than 6 in. to 9 in.	4
More than 9 in. to 12 in.	6
More than 12 in. to 15 in.	8
More than 15 in. to 18 in.	9½
More than 18 in. to 24 in.	12½
More than 24 in. to 30 in.	15½
More than 30 in.	18

Table 8.10.7.2.2 Suspended or Floor-Mounted Obstructions (Residential Sidewall Sprinklers) in Light Hazard Occupancies Only

Horizontal Distance (A)	Minimum Allowable Distance Below Deflector (in.) (B)
--------------------------------	---

For SI units, 1 in. = 25.4 mm.

Note: For (A) and (B), refer to Figure 8.10.7.2.2.

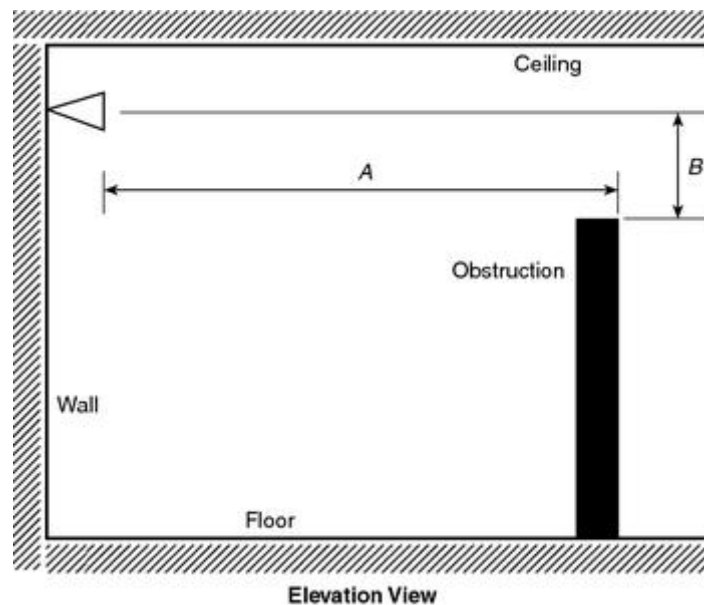

FIGURE 8.10.7.2.2 Suspended or Floor-Mounted Obstructions (Residential Sidewall Sprinklers) in Light Hazard Occupancies Only.

8.10.7.3* Obstructions That Prevent Sprinkler Discharge from Reaching the Hazard.

8.10.7.3.1 Continuous or noncontinuous obstructions that interrupt the water discharge in a horizontal plane more than 18 in. (457 mm) below the sprinkler deflector in a manner to limit the distribution from reaching the protected hazard shall comply with this section.

8.10.7.3.2 Sprinklers shall be installed under fixed obstructions over 4 ft (1.2 m) wide, such as ducts, stairs, and landings.

8.10.7.3.3 Sprinklers shall not be required under obstructions that are not fixed in place.

8.10.7.3.4 Sprinklers installed under open gratings shall be shielded from the discharge of overhead sprinklers.

8.11 Large Drop Sprinklers.

8.11.1 General. All requirements of Section 8.5 shall apply to large drop sprinklers except as modified in Section 8.11.

8.11.2* Protection Areas per Sprinkler (Large Drop Sprinklers).

8.11.2.1 Determination of the Protection Area of Coverage. The protection area of coverage per sprinkler (A_s) shall be determined in accordance with 8.5.2.1.

8.11.2.2 Maximum Protection Area of Coverage.

8.11.2.2.1 The maximum allowable protection area of coverage for a sprinkler (A_s) shall be in accordance with the value indicated in Table 8.11.2.2.1.

Table 8.11.2.2.1 Protection Areas and Maximum Spacing for Large Drop Sprinklers

Construction Type	Protection Area		Maximum Spacing	
	ft ²	m ²	ft	m
Noncombustible unobstructed	130	12.1	12	3.7
Noncombustible obstructed	130	12.1	12	3.7
Combustible unobstructed	130	12.1	12	3.7
Combustible obstructed	100	9.3	10	3.1
Rack storage applications	100	9.3	10	3.1

8.11.2.2.2 In any case, the maximum area of coverage of any sprinkler shall not exceed 130 ft² (12.9 m²).

8.11.2.3 Minimum Protection Area of Coverage. The minimum allowable protection area of coverage for a sprinkler (A_s) shall be not less than 80 ft² (7.4 m²).

8.11.3 Sprinkler Spacing (Large Drop Sprinklers).

8.11.3.1* Maximum Distance Between Sprinklers.

8.11.3.1.1 Under unobstructed and obstructed noncombustible construction and unobstructed combustible construction, the distance between sprinklers shall be limited to not more than 12 ft (3.7 m) between sprinklers, as shown in Table 8.11.2.2.1.

8.11.3.1.2 Under obstructed combustible construction, the maximum distance shall be limited to 10 ft (3 m).

8.11.3.2 Maximum Distance from Walls. The distance from sprinklers to walls shall not exceed one-half of the allowable distance permitted between sprinklers as indicated in Table 8.11.2.2.1.

8.11.3.3 Minimum Distance from Walls. Sprinklers shall be located a minimum of 4 in. (102 mm) from a wall.

8.11.3.4 Minimum Distance Between Sprinklers. Sprinklers shall be spaced not less than 8 ft (2.4 m) on center.

8.11.4 Deflector Position (Large Drop Sprinklers).

8.11.4.1* Distance Below Ceilings.

8.11.4.1.1 Unobstructed Construction. Under unobstructed construction, the distance between the sprinkler deflector and the ceiling shall be a minimum of 6 in. (152 mm) and a maximum of 8 in. (203 mm).

8.11.4.1.2 Obstructed Construction. Under obstructed construction, the sprinkler deflector shall be located in accordance with one of the following arrangements:

- (1) Installed with the deflectors located a minimum of 6 in. (152 mm) and a maximum of 12 in. (305 mm) from the ceiling.
- (2) Installed with the deflectors within the horizontal planes 1 in. to 6 in. below wood joist or composite wood joist construction, to a maximum distance of 22 in. (559 mm) below the ceiling/roof or deck.
- (3) Installed with deflectors of sprinklers under concrete tee construction with stems spaces less than 7½ ft (2.3 m) but more than 3 ft (0.9 m) on centers, regardless of the depth of the tee, located at or above a horizontal plane 1 in. (25.4 mm) below the bottom of the stems of the tees and shall comply with Table 8.11.5.1.2.

8.11.4.2 Deflector Orientation. Deflectors of sprinklers shall be aligned parallel to ceilings or roofs.

8.11.5* Obstructions to Sprinkler Discharge (Large Drop Sprinklers).

8.11.5.1 Performance Objective.

8.11.5.1.1 Sprinklers shall be located so as to minimize obstructions to discharge as defined in 8.5.5.2 and 8.5.5.3, or additional sprinklers shall be provided to ensure adequate coverage of the hazard.

8.11.5.1.2 Sprinklers shall be arranged to comply with 8.5.5.2, Table 8.11.5.1.2, and Figure 8.11.5.1.2.

Table 8.11.5.1.2 Positioning of Sprinklers to Avoid Obstructions to Discharge (Large Drop Sprinkler)

Distance from Sprinkler to Side of Obstruction (A)	Maximum Allowable Distance of Deflector Above Bottom of Obstruction (in.) (B)
Less than 1 ft	0
1 ft to less than 1 ft 6 in.	1½

Table 8.11.5.1.2 Positioning of Sprinklers to Avoid Obstructions to Discharge (Large Drop Sprinkler)

Distance from Sprinkler to Side of Obstruction (<i>A</i>)	Maximum Allowable Distance of Deflector Above Bottom of Obstruction (in.) (<i>B</i>)
1 ft 6 in. to less than 2 ft	3
2 ft to less than 2 ft 6 in.	5½
2 ft 6 in. to less than 3 ft	8
3 ft to less than 3 ft 6 in.	10
3 ft 6 in. to less than 4 ft	12
4 ft to less than 4 ft 6 in.	15
4 ft 6 in. to less than 5 ft	18
5 ft to less than 5 ft 6 in.	22
5 ft 6 in. to less than 6 ft	26
6 ft	31

For SI units, 1 in. = 25.4 mm; 1 ft = 0.3048 m.

Note: For (*A*) and (*B*), refer to Figure 8.11.5.1.2.

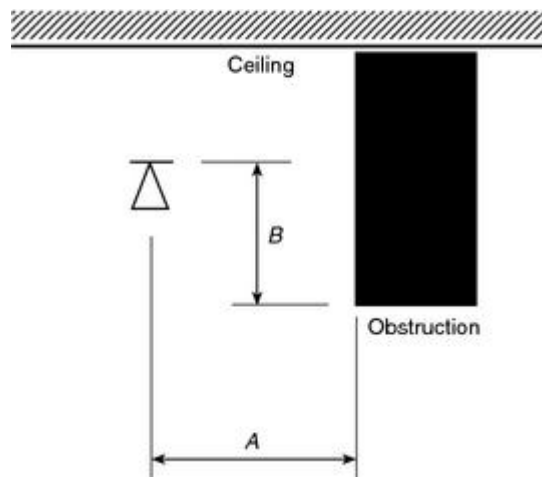

FIGURE 8.11.5.1.2 Positioning of Sprinklers to Avoid Obstructions to Discharge (Large Drop Sprinkler).

8.11.5.1.3 The requirements of 8.11.5.1.2 shall not apply where sprinklers are positioned on opposite sides of the obstruction.

8.11.5.2 Obstructions to Sprinkler Discharge Pattern Development.

8.11.5.2.1 General.

8.11.5.2.1.1 Continuous or noncontinuous obstructions less than or equal to 36 in. (914 mm) below the sprinkler deflector that prevent the pattern from fully developing shall comply with 8.11.5.2.

8.11.5.2.1.2 Regardless of the rules of this section, solid continuous obstructions shall meet the requirements of 8.11.5.1.2 or 8.11.5.1.3.

8.11.5.2.1.3* Unless the requirements of 8.11.5.1.2 or 8.11.5.1.3 are met, for obstructions 8 in. (203 mm) or less in width, as shown in Figure 8.11.5.2.1.3, sprinklers shall be positioned such that they are located at least a distance three times greater than the maximum dimension of the obstruction from the sprinkler (e.g., webs and chord members, pipe, columns, and fixtures).

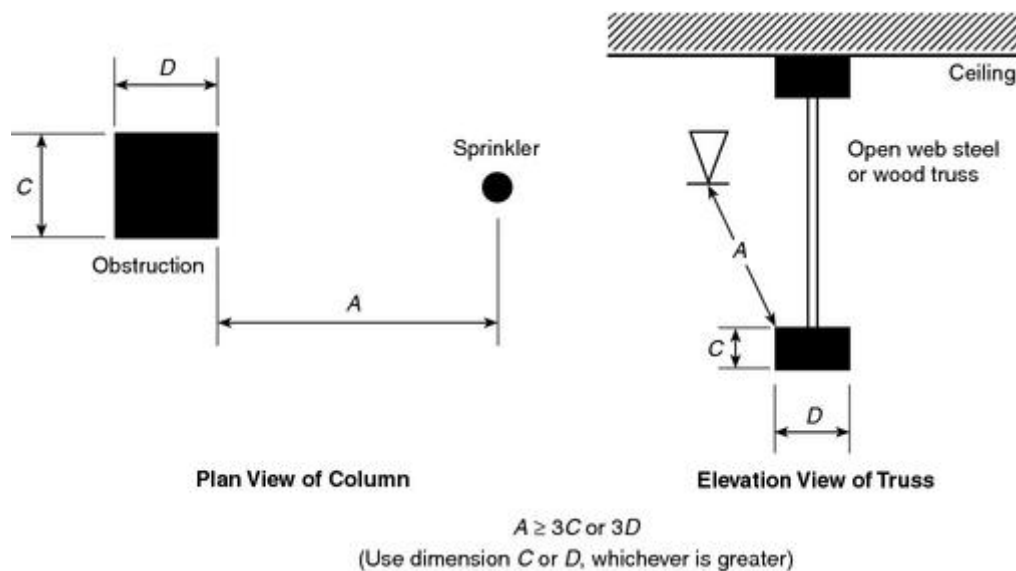

FIGURE 8.11.5.2.1.3 Minimum Distance from Obstruction (Large Drop Sprinkler).

8.11.5.2.2 Branch Lines. Sprinklers shall be positioned with respect to branch lines in accordance with one of the following:

- (1) Sprinklers shall be permitted to be attached directly to branch lines less than or equal to 2 in. (51 mm) nominal in diameter.
- (2) Sprinklers shall be permitted to be offset horizontally a minimum of 12 in. (305 mm) from the pipe.
- (3) Sprinklers shall be permitted to be supplied by a riser nipple to elevate the sprinkler deflector a minimum of 13 in. (330 mm) from the centerline of 2½ in. (64 mm) pipe.
- (4) Sprinklers shall be permitted to be supplied by a riser nipple to elevate the sprinkler deflector a minimum of 15 in. (380 mm) from the centerline of 3 in. (76 mm) pipe.

8.11.5.3* Obstructions that Prevent Sprinkler Discharge from Reaching the Hazard.

8.11.5.3.1 Continuous or noncontinuous obstructions that interrupt the water discharge in a horizontal plane below the sprinkler deflector in a manner to limit the distribution from reaching the protected hazard shall comply with 8.11.5.3.

8.11.5.3.2 Sprinklers shall be positioned with respect to fluorescent lighting fixtures, ducts, and obstructions more than 24 in. (610 mm) wide and located entirely below the sprinklers so that the minimum horizontal distance from the near side of the obstruction to the center of

the sprinkler is not less than the value specified in Table 8.11.5.3.2 and Figure 8.11.5.3.2.

Table 8.11.5.3.2 Obstruction Entirely Below the Sprinkler (Large Drop Sprinkler)

Distance of Deflector Above Bottom of Obstruction (<i>B</i>)	Minimum Distance to Side of Obstruction (ft) (<i>A</i>)
Less than 6 in.	1½
6 in. to less than 12 in.	3
12 in. to less than 18 in.	4
18 in. to less than 24 in.	5
24 in. to less than 30 in.	5½
30 in. to less than 36 in.	6

For SI units, 1 in. = 25.4 mm; 1 ft = 0.3048 m.
Note: For (*A*) and (*B*), refer to Figure 8.11.5.3.2.

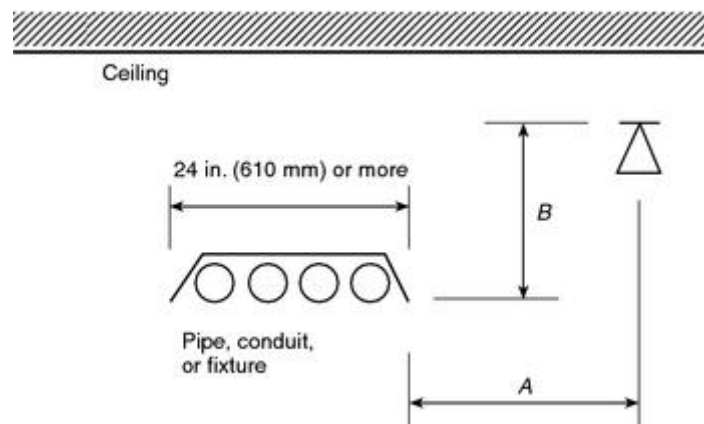

FIGURE 8.11.5.3.2 Obstruction Entirely Below the Sprinkler (Large Drop Sprinkler).

8.11.5.3.3 Sprinklers installed under open gratings shall be shielded from the discharge of overhead sprinklers.

8.11.5.3.4 Where the bottom of the obstruction is located 24 in. (610 mm) or more below the sprinkler deflectors, the following shall occur:

- (1) Sprinklers shall be positioned so that the obstruction is centered between adjacent sprinklers in accordance with Figure 8.11.5.3.4.
- (2) The obstruction width shall meet the following requirements:
 - (a) The obstruction shall be limited to a maximum width of 24 in. (610 mm) in accordance with Figure 8.11.5.3.4.
 - (b) Where the obstruction is greater than 24 in. (610 mm) wide, one or more lines of sprinklers shall be installed below the obstruction.
- (3) The obstruction extension shall meet the following requirements:

- (a) The obstruction shall not extend more than 12 in. (305 mm) to either side of the midpoint between sprinklers in accordance with Figure 8.11.5.3.4.
 - (b) Where the extensions of the obstruction exceed 12 in. (305 mm), one or more lines of sprinklers shall be installed below the obstruction.
- (4) At least 18 in. (457 mm) clearance shall be maintained between the top of storage and the bottom of the obstruction in accordance with Figure 8.11.5.3.4.

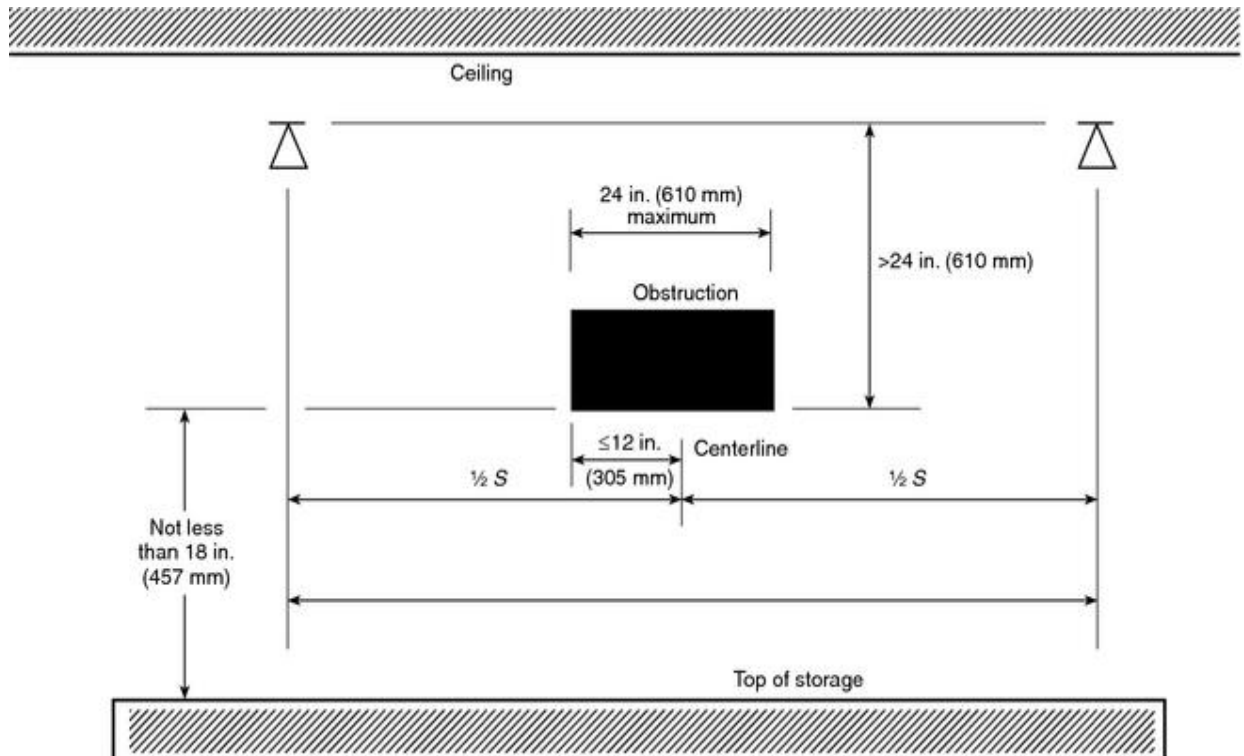

FIGURE 8.11.5.3.4 Obstruction More Than 24 in. (610 mm) Below the Sprinkler (Large Drop Sprinkler).

8.11.5.3.5 In the special case of an obstruction running parallel to and directly below a branch line, the following shall occur:

- (1) The sprinkler shall be located at least 36 in. (914 mm) above the top of the obstruction in accordance with Figure 8.11.5.3.5.
- (2) The obstruction shall be limited to a maximum width of 12 in. (305 mm) in accordance with Figure 8.11.5.3.5.
- (3) The obstruction shall be limited to a maximum extension of 6 in. (152 mm) to either side of the centerline of the branch line in accordance with Figure 8.11.5.3.5.

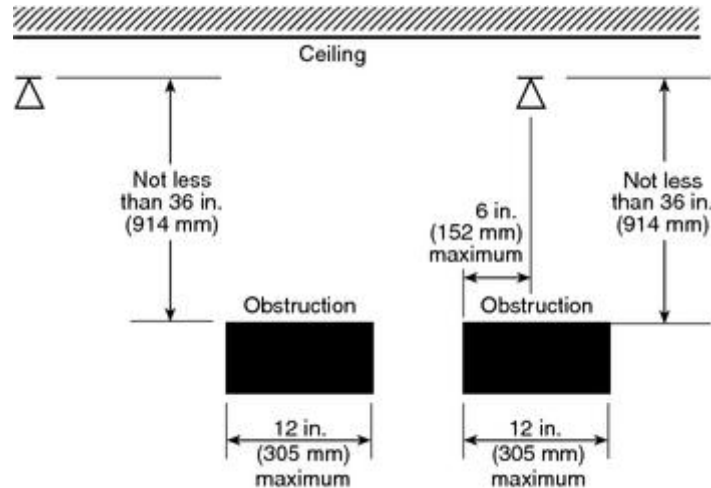

FIGURE 8.11.5.3.5 Obstruction More Than 36 in. (914 mm) Below the Sprinkler (Large Drop Sprinkler).

8.11.6 Clearance to Storage (Large Drop Sprinklers). The clearance between the deflector and the top of storage shall be 36 in. (914 mm) or greater.

8.12 Early Suppression Fast-Response Sprinklers.

8.12.1 General. All requirements of Section 8.5 shall apply except as modified in Section 8.12.

8.12.2 Protection Areas per Sprinkler (Early Suppression Fast-Response Sprinklers).

8.12.2.1 Determination of the Protection Area of Coverage. The protection area of coverage per sprinkler (A_s) shall be determined in accordance with 8.5.2.1.

8.12.2.2 Maximum Protection Area of Coverage.

8.12.2.2.1 The maximum allowable protection area of coverage for a sprinkler (A_s) shall be in accordance with the value indicated in Table 8.12.2.2.1.

Table 8.12.2.2.1 Protection Areas and Maximum Spacing of ESFR Sprinkler

Construction Type	Ceiling/Roof Heights Up to 30 ft (9.1 m)				Ceiling/Roof Heights C	
	Protection Area		Spacing		Protection Area	
	ft ²	m ²	ft	m	ft ²	m ²
Noncombustible unobstructed	100	9.3	12	3.7	100	9.3
Noncombustible obstructed	100	9.3	12	3.7	100	9.3
Combustible unobstructed	100	9.3	12	3.7	100	9.3
Combustible obstructed	N/A		N/A		N/A	

8.12.2.2.2 Unless the requirements of 8.12.2.2.3 are met, the maximum area of coverage of any sprinkler shall not exceed 100 ft² (9.3 m²).

8.12.2.2.3* It shall be permitted to deviate from the maximum sprinkler spacing to eliminate
Copyright NFPA

obstructions created by structural elements (such as trusses, bar joists, and wind bracing) by moving a sprinkler along the branch line a maximum of 1 ft (0.31 m) from its allowable spacing, provided coverage for that sprinkler does not exceed 110 ft² (10.2 m²) per sprinkler where all of the following conditions are met:

- (1) The average actual floor area protected by the moved sprinkler and the adjacent sprinklers shall not exceed 100 ft² (9.3 m²).
- (2) Adjacent branch lines shall maintain the same pattern.
- (3) In no case shall the distance between sprinklers exceed 12 ft (3.7 m).

8.12.2.2.4 Deviations from the maximum sprinkler spacing shall be permitted to eliminate obstructions created by structural elements (such as trusses, bar joists, and wind bracing) by moving a single branch line a maximum of 1 ft (0.31 m) from its allowable spacing, provided coverage for the sprinklers on that branch line and the sprinklers on the branch line it is moving away from does not exceed 110 ft² (10.2 m²) per sprinkler where all of the following conditions are met:

- (1) The average actual floor area protected by the sprinklers on the moved branch line and the sprinklers on the adjacent branch lines shall not exceed 100 ft² (9.3 m²) per sprinkler.
- (2) In no case shall the distance between sprinklers exceed 12 ft (3.7 m).
- (3) It shall not be permitted to move a branch line where there are moved sprinklers on a branch line that exceed the maximum sprinkler spacing.

8.12.2.3 Minimum Protection Area of Coverage. The minimum allowable protection area of coverage for a sprinkler (A_s) shall not be less than 64 ft² (6 m²).

8.12.3 Sprinkler Spacing (Early Suppression Fast-Response Sprinklers).

8.12.3.1 Maximum Distance Between Sprinklers. The maximum distance between sprinklers shall be in accordance with the following:

- (1) Where the storage height is less than or equal to 25 ft (7.6 m) and the ceiling height is less than or equal to 30 ft (9.1 m), the distance between sprinklers shall be limited to not more than 12 ft (3.7 m) between sprinklers as shown in Table 8.12.2.2.1.
- (2) Unless the requirements of 8.12.3.1(3) or 8.12.3.1(4) are met, where the storage height exceeds 25 ft (7.6 m) and ceiling height exceeds 30 ft (9.1 m), the distance between sprinklers shall be limited to not more than 10 ft (3 m) between sprinklers.
- (3)* Regardless of the storage or ceiling height arrangement, it shall be permitted to deviate from the maximum sprinkler spacing to eliminate obstructions created by trusses and bar joists by moving a sprinkler along the branch line a maximum of 1 ft (0.31 m) from its allowable spacing, provided coverage for that sprinkler does not exceed 110 ft² (10.2 m²) where all of the following conditions are met:
 - (a) The average actual floor area protected by the moved sprinkler and the adjacent sprinklers shall not exceed 100 ft² (9.3 m²).

- (b) Adjacent branch lines shall maintain the same pattern.
 - (c) In no case shall the distance between sprinklers exceed 12 ft (3.7 m).
- (4) Where branch lines are parallel to trusses and bar joists, it shall be permitted to deviate from the maximum sprinkler spacing to eliminate obstructions created by trusses and bar joists by moving a single branch line a maximum of 1 ft (0.31 m) from its allowable spacing, provided coverage for the sprinklers on that branch line and the sprinklers on the branch line it is moving away from does not exceed 110 ft² (10.2 m²) per sprinkler where all of the following conditions are met:
- (a) The average actual floor area protected by the sprinklers on the moved branch line and the sprinklers on the adjacent branch lines shall not exceed 100 ft² (9.3 m²) per sprinkler.
 - (b) In no case shall the distance between sprinklers exceed 12 ft (3.7 m).
 - (c) It shall not be permitted to move a branch line where there are moved sprinklers on a branch line that exceed the maximum sprinkler spacing.

8.12.3.2 Maximum Distance from Walls. The distance from sprinklers to walls shall not exceed one-half of the allowable distance permitted between sprinklers as indicated in Table 8.12.2.2.1.

8.12.3.3 Minimum Distance from Walls. Sprinklers shall be located a minimum of 4 in. (102 mm) from a wall.

8.12.3.4 Minimum Distance Between Sprinklers. Sprinklers shall be spaced not less than 8 ft (2.4 m) on center.

8.12.4 Deflector Position (Early Suppression Fast-Response Sprinklers).

8.12.4.1 Distance Below Ceilings.

8.12.4.1.1 Pendent sprinklers with a nominal K-factor of 14 shall be positioned so that deflectors are a maximum 14 in. (356 mm) and a minimum 6 in. (152 mm) below the ceiling.

8.12.4.1.2 Pendent sprinklers with a nominal K-factor of 16.8 shall be positioned so that deflectors are a maximum 14 in. (356 mm) and a minimum 6 in. (152 mm) below the ceiling.

8.12.4.1.3 Pendent sprinklers with a nominal K-factor of 22.4 and 25.2 shall be positioned so that deflectors are a maximum 18 in. (457 mm) and a minimum 6 in. (152 mm) below the ceiling.

8.12.4.1.4 Upright sprinklers with a nominal K-factor of 14 shall be positioned so that the deflector is 3 in. to 12 in. (76 mm to 305 mm) below the ceiling.

8.12.4.1.5 Upright sprinklers with a nominal K-factor of 16.8 shall be positioned so that the deflector is 3 in. to 12 in. (76 mm to 305 mm) below the ceiling.

8.12.4.1.6 With obstructed construction, the branch lines shall be permitted to be installed across the beams, but sprinklers shall be located in the bays and not under the beams.

8.12.4.2 Deflector Orientation. Deflectors of sprinklers shall be aligned parallel to ceilings or roofs.

8.12.5 Obstructions to Sprinkler Discharge (Early Suppression Fast-Response Sprinklers).

8.12.5.1 Obstructions at or Near the Ceiling.

8.12.5.1.1 Sprinklers shall be arranged to comply with Table 8.12.5.1.1 and Figure 8.12.5.1.1 for obstructions at the ceiling, such as beams, ducts, lights, and top chords of trusses and bar joists.

Table 8.12.5.1.1 Positioning of Sprinklers to Avoid Obstructions to Discharge (ESFR Sprinkler)

Distance from Sprinkler to Side of Obstruction (<i>A</i>)	Maximum Allowable Distance of Deflector Above Bottom of Obstruction (in.) (<i>B</i>)
Less than 1 ft	0
1 ft to less than 1 ft 6 in.	1½
1 ft 6 in. to less than 2 ft	3
2 ft to less than 2 ft 6 in.	5½
2 ft 6 in. to less than 3 ft	8
3 ft to less than 3 ft 6 in.	10
3 ft 6 in. to less than 4 ft	12
4 ft to less than 4 ft 6 in.	15
4 ft 6 in. to less than 5 ft	18
5 ft to less than 5 ft 6 in.	22
5 ft 6 in. to less than 6 ft	26
6 ft	31

For SI units, 1 in. = 25.4 mm; 1 ft = 0.3048 m.
 Note: For (*A*) and (*B*), refer to Figure 8.12.5.1.1.

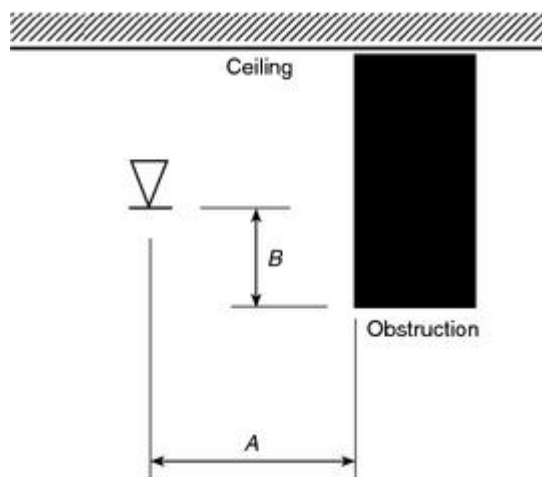

FIGURE 8.12.5.1.1 Positioning of Sprinklers to Avoid Obstructions to Discharge (ESFR Sprinkler).

8.12.5.1.2 The requirements of 8.12.5.1.1 shall not apply where sprinklers are spaced on opposite sides of obstructions less than 24 in. (610 mm) wide, provided the distance from the centerline on the obstructions to the sprinklers does not exceed one-half the allowable distance between sprinklers.

8.12.5.1.3 Sprinklers with a special obstruction allowance shall be installed according to their listing.

8.12.5.2* Isolated Obstructions Below the Elevation of Sprinklers. Sprinklers shall be arranged with respect to obstructions in accordance with one of the following:

- (1) Sprinklers shall be installed below isolated noncontinuous obstructions that restrict only one sprinkler and are located below the elevation of sprinklers such as light fixtures and unit heaters.
- (2) Additional sprinklers shall not be required where the obstruction is 2 ft (0.6 m) or less in width and the sprinkler is located horizontally 1 ft (0.3 m) or greater from the nearest edge of the obstruction.
- (3) Additional sprinklers shall not be required where sprinklers are positioned with respect to the bottom of obstructions in accordance with 8.12.5.1.
- (4) Additional sprinklers shall not be required where the obstruction is 2 in. (51 mm) or less in width and is located a minimum of 2 ft (0.6 m) below the elevation of the sprinkler deflector or is positioned a minimum of 1 ft (0.3 m) horizontally from the sprinkler.
- (5) Sprinklers with a special obstruction allowance shall be installed according to their listing.

8.12.5.3 Continuous Obstructions Below the Sprinklers.

8.12.5.3.1 General Continuous Obstructions. Sprinklers shall be arranged with respect to obstructions in accordance with one of the following:

- (1) Sprinklers shall be installed below continuous obstructions, or they shall be arranged to comply with Table 8.12.5.1.1 for horizontal obstructions entirely below the elevation of sprinklers that restrict sprinkler discharge pattern for two or more adjacent sprinklers such as ducts, lights, pipes, and conveyors.
- (2) Additional sprinklers shall not be required where the obstruction is 2 in. (51 mm) or less in width and is located a minimum of 2 ft (0.6 m) below the elevation of the sprinkler deflector or is positioned a minimum of 1 ft (0.3 m) horizontally from the sprinkler.
- (3) Additional sprinklers shall not be required where the obstruction is 1 ft (0.3 m) or less in width and located a minimum of 1 ft (0.3 m) horizontally from the sprinkler.
- (4) Additional sprinklers shall not be required where the obstruction is 2 ft (0.6 m) or

less in width and located a minimum of 2 ft (0.6 m) horizontally from the sprinkler.

- (5) Ceiling sprinklers shall not be required to comply with Table 8.12.5.1.1 where a row of sprinklers is installed under the obstruction.

8.12.5.3.2 Bottom Chords of Bar Joists or Open Trusses. ESFR sprinklers shall be positioned a minimum of 1 ft (0.3 m) horizontally from the nearest edge to any bottom chord of a bar joist or open truss.

8.12.5.3.3 Open Gratings. Sprinklers installed under open gratings shall be of the intermediate level/rack storage type or otherwise shielded from the discharge of overhead sprinklers.

8.12.5.3.4 Overhead Doors. Quick-response spray sprinklers shall be permitted to be utilized under overhead doors.

8.12.5.3.5 Special Obstruction Allowance. Sprinklers with a special obstruction allowance shall be installed according to their listing.

8.12.6 Clearance to Storage (Early Suppression Fast-Response Sprinklers). The clearance between the deflector and the top of storage shall be 36 in. (914 mm) or greater.

8.13 In-Rack Sprinklers.

8.13.1 System Size. The area protected by a single system of sprinklers in racks shall not exceed 40,000 ft² (3716 m²) of floor area occupied by the racks, including aisles, regardless of the number of levels of in-rack sprinklers.

8.13.2 Type of In-Rack Sprinklers.

8.13.2.1 Sprinklers in racks shall be ordinary-temperature standard-response or quick-response classification with a nominal K-factor of K-5.6 or 8.0 (80 or 115), pendent or upright.

8.13.2.2 Sprinklers with intermediate- and high-temperature ratings shall be used near heat sources as required by 8.3.2.

8.13.3 In-Rack Sprinkler Water Shields.

8.13.3.1 In-Rack Sprinkler Water Shields for Storage of Class I Through Class IV Commodities. Water shields shall be provided directly above in-rack sprinklers, or listed intermediate level/rack storage sprinklers shall be used where there is more than one level, if not shielded by horizontal barriers. (*See Section C.3.*)

8.13.3.2 In-Rack Sprinkler Water Shields for Plastic Storage. Where in-rack sprinklers are not shielded by horizontal barriers, water shields shall be provided above the sprinklers, or listed intermediate level/rack storage sprinklers shall be used.

8.13.4 Location, Position, and Spacing of In-Rack Sprinklers. See Chapter 12 through Chapter 20 as appropriate.

8.13.4.1 Minimum Distance Between In-Rack Sprinklers. In-rack sprinklers shall be

permitted to be placed less than 6 ft (1.8 m) on center.

8.13.5 Obstructions to In-Rack Sprinkler Discharge. In-rack sprinklers shall not be required to meet the obstruction criteria and clearance from storage requirements of Section 8.5.

8.14 Pilot Line Detectors.

8.14.1 Pilot line detectors and related components including pipe and fittings shall be corrosion resistant when installed in areas exposed to weather or corrosive conditions.

8.14.2 Where subject to mechanical or physical damage, pilot line detectors and related detection system components shall be protected.

8.14.3 Where spray sprinklers are used as pilot line detectors, they shall be installed in accordance with Section 8.14 and the spacing and location rules of Section 8.6, except that the obstruction to water distribution rules for automatic sprinklers shall not be required to be followed.

8.14.3.1 Where located under a ceiling, pilot sprinklers shall be positioned in accordance with the requirements of Section 8.6.

8.14.4 The temperature rating of spray sprinklers utilized as pilot line detectors shall be selected in accordance with 8.3.2.

8.14.5 Maximum horizontal spacing for indoor locations shall not exceed 12 ft (3.7 m).

8.14.6 Pilot line detectors shall be permitted to be spaced more than 22 in. (559 mm) below a ceiling or deck where the maximum spacing between pilot line detectors is 10 ft (3 m) or less.

8.14.6.1 Other maximum horizontal spacing differing from those required in 8.14.5 shall be permitted where installed in accordance with their listing.

8.14.7 Pilot line detectors located outdoors, such as in open process structures, shall be spaced such that the elevation of a single level of pilot line detectors and between additional levels of pilot line detectors shall not exceed 17 ft (5.2 m).

8.14.8 The maximum distance between pilot line detectors installed outdoors shall not exceed 8 ft (2.5 m).

8.14.8.1 The horizontal distance between pilot line detectors installed outdoors on a given level shall be permitted to be increased to 10 ft (3 m) when all of the following conditions are met:

- (1) The elevation of the first level does not exceed 15 ft (4.6 m).
- (2) The distance between additional levels does not exceed 12 ft (3.7 m).
- (3) The pilot line actuators are staggered vertically.

8.14.8.2 Alternate vertical spacing of pilot line detectors differing from those required in 8.14.8.1 shall be permitted where installed in accordance with their listing.

8.14.9 Pilot line detectors located in open-sided buildings shall follow the indoor spacing rules.

8.14.9.1 A row of pilot line detectors spaced in accordance with the outdoor pilot line detector spacing rules shall be located along the open sides of open-sided buildings.

8.14.9.2 Pilot line detectors located under open gratings shall be spaced in accordance with the outdoor rules.

8.14.9.3 Where two or more adjacent water spray systems in one fire area are controlled by separate pilot line detector systems, the detectors on each system shall be spaced independently as if the dividing line between the systems were a wall or draft curtain.

8.14.9.4 Where pilot line detectors are installed in water cooling tower applications, they shall be in accordance with Section 21.24.

8.14.10 Pipe supplying pilot line detectors shall be permitted to be supported from the same points of hanger attachment as the piping system it serves.

8.14.10.1 Pipe supplying pilot line detectors shall not be required to meet the requirements of 9.3.5.

8.15 Special Situations.

8.15.1 Concealed Spaces.

8.15.1.1 Concealed Spaces Requiring Sprinkler Protection. All concealed spaces enclosed wholly or partly by exposed combustible construction shall be protected by sprinklers except in concealed spaces where sprinklers are not required to be installed by 8.15.1.2.1 through 8.15.1.2.16 and 8.15.6.

8.15.1.2* Concealed Spaces Not Requiring Sprinkler Protection.

8.15.1.2.1* Concealed spaces of noncombustible and limited-combustible construction with minimal combustible loading having no access shall not require sprinkler protection. The space shall be considered a concealed space even with small openings such as those used as return air for a plenum. *(For additional information on combustible loading, see A.8.15.1.2.1.)*

8.15.1.2.2 Concealed spaces of noncombustible and limited-combustible construction with limited access and not permitting occupancy or storage of combustibles shall not require sprinkler protection. The space shall be considered a concealed space even with small openings such as those used as return air for a plenum.

8.15.1.2.3 Concealed spaces formed by studs or joists with less than 6 in. (152 mm) between the inside or near edges of the studs or joists shall not require sprinkler protection. *(See Figure 8.6.4.1.5.1.)*

8.15.1.2.4 Concealed spaces formed by bar joists with less than 6 in. (152 mm) between the roof or floor deck and ceiling shall not require sprinkler protection.

8.15.1.2.5 Concealed spaces formed by ceilings attached directly to or within 6 in. (152 mm)

of wood joist construction shall not require sprinkler protection.

8.15.1.2.6* Concealed spaces formed by ceilings attached to composite wood joist construction either directly or onto metal channels not exceeding 1 in. (25.4 mm) in depth, provided the joist channels are firestopped into volumes each not exceeding 160 ft³ (4.53 m³) using materials equivalent to the web construction and at least 3½ in. (90 mm) of batt insulation is installed at the bottom of the joist channels when the ceiling is attached utilizing metal channels, shall not require sprinkler protection.

8.15.1.2.7 Concealed spaces entirely filled with noncombustible insulation shall not require sprinkler protection.

8.15.1.2.8 Concealed spaces within wood joist construction and composite wood joist construction having noncombustible insulation filling the space from the ceiling up to the bottom edge of the joist of the roof or floor deck, provided that in composite wood joist construction the joist channels are firestopped into volumes each not exceeding 160 ft³ (4.53 m³) to the full depth of the joist with material equivalent to the web construction, shall not require sprinkler protection.

8.15.1.2.9 Concealed spaces over isolated small rooms not exceeding 55 ft² (5.1 m²) in area shall not require sprinkler protection.

8.15.1.2.10 Concealed spaces where rigid materials are used and the exposed surfaces have a flame spread index of 25 or less, and the materials have been demonstrated not to propagate fire when tested in accordance with NFPA 255, *Standard Method of Test of Surface Burning Characteristics of Building Materials*, extended for an additional 20 minutes in the form in which they are installed, shall not require sprinkler protection.

8.15.1.2.11 Concealed spaces in which the exposed materials are constructed entirely of fire-retardant treated wood as defined by NFPA 703, *Standard for Fire Retardant-Treated Wood and Fire-Retardant Coatings for Building Materials*, shall not require sprinkler protection.

8.15.1.2.12 Noncombustible concealed spaces having exposed combustible insulation where the heat content of the facing and substrate of the insulation material does not exceed 1000 Btu/ft² (11,356 kJ/m²) shall not require sprinkler protection.

8.15.1.2.13 Concealed spaces below insulation that is laid directly on top of or within wood joists or composite wood joists used as ceiling joists in an otherwise sprinklered concealed space, with the ceiling attached directly to the bottom of the joists, shall not require sprinkler protection.

8.15.1.2.14 Vertical pipe chases under 10 ft² (0.93 m²), where provided in multifloor buildings where the chases are firestopped at each floor using materials equivalent to the floor construction, and where such pipe chases shall contain no sources of ignition, piping shall be noncombustible and pipe penetrations at each floor shall be properly sealed and shall not require sprinkler protection.

8.15.1.2.15 Exterior columns under 10 ft² (0.93 m²) in area, formed by studs or wood joist supporting exterior canopies that are fully protected with a sprinkler system, shall not require

sprinkler protection.

8.15.1.2.16* Concealed spaces formed by noncombustible or limited combustible ceilings suspended from the bottom of wood joists, composite wood joists, wood bar joists, or wood trusses that have insulation filling all of the gaps between the bottom of the trusses or joists, and where sprinklers are present in the space above the insulation within the trusses or joists, shall not require sprinkler protection. The heat content of the facing, substrate, and support of the insulation material shall not exceed 1000 Btu/ft² (11,356 kJ/m²).

8.15.1.3 Concealed Space Design Requirements. Sprinklers in concealed spaces having no access for storage or other use shall be installed in accordance with the requirements for light hazard occupancy.

8.15.1.4 Heat-Producing Devices with Composite Wood Joist Construction. Where heat-producing devices such as furnaces or process equipment are located in the joist channels above a ceiling attached directly to the underside of composite wood joist construction that would not otherwise require sprinkler protection of the spaces, the joist channel containing the heat-producing devices shall be sprinklered by installing sprinklers in each joist channel, on each side, adjacent to the heat-producing device.

8.15.1.5 Localized Protection of Exposed Combustible Construction or Exposed Combustibles. In concealed spaces having exposed combustible construction, or containing exposed combustibles, in localized areas, the combustibles shall be protected as follows:

- (1) If the exposed combustibles are in the vertical partitions or walls around all or a portion of the enclosure, a single row of sprinklers spaced not over 12 ft (3.7 m) apart nor more than 6 ft (1.8 m) from the inside of the partition shall be permitted to protect the surface. The first and last sprinklers in such a row shall not be over 5 ft (1.5 m) from the ends of the partitions.
- (2) If the exposed combustibles are in the horizontal plane, the area of the combustibles shall be permitted to be protected with sprinklers on a light hazard spacing. Additional sprinklers shall be installed no more than 6 ft (1.8 m) outside the outline of the area and not more than 12 ft (3.7 m) on center along the outline. When the outline returns to a wall or other obstruction, the last sprinkler shall not be more than 6 ft (1.8 m) from the wall or obstruction.

8.15.1.6 Sprinklers used in horizontal combustible concealed spaces (with a slope not exceeding 2 in 12) with combustible wood truss or wood joist construction having a combustible upper surface and where the depth of the space is less than 36 in. (914 mm) from deck to deck or with double wood joist construction with a maximum of 36 in. (914 mm) between the top of the bottom joist and the bottom of the upper joist shall be listed for such use.

8.15.1.7 Sprinklers specifically listed to provide protection of combustible concealed spaces described in 8.15.1.6 shall be permitted to protect composite wood joist construction with a maximum of 36 in. (914 mm) between the top of the bottom joist and the bottom of the upper joist.

8.15.2 Vertical Shafts.

8.15.2.1 General. Unless the requirements of 8.15.2.1.1 or 8.15.2.1.2 are met, one sprinkler shall be installed at the top of shafts.

8.15.2.1.1 Noncombustible or limited-combustible, nonaccessible vertical duct shafts shall not require sprinkler protection.

8.15.2.1.2 Noncombustible or limited-combustible, nonaccessible vertical electrical or mechanical shafts shall not require sprinkler protection.

8.15.2.2* Shafts with Combustible Surfaces.

8.15.2.2.1 Where vertical shafts have combustible surfaces, one sprinkler shall be installed at each alternate floor level.

8.15.2.2.2 Where a shaft having combustible surfaces is trapped, an additional sprinkler shall be installed at the top of each trapped section.

8.15.2.3 Accessible Shafts with Noncombustible Surfaces. Where accessible vertical shafts have noncombustible surfaces, one sprinkler shall be installed near the bottom.

8.15.3 Stairways.

8.15.3.1 Combustible Construction. Sprinklers shall be installed beneath all stairways of combustible construction.

8.15.3.2 Noncombustible Construction.

8.15.3.2.1 In noncombustible stair shafts having noncombustible stairs with noncombustible or limited combustible finishes, sprinklers shall be installed at the top of the shaft and under the first landing above the bottom of the shaft.

8.15.3.2.2 Where noncombustible stair shafts are divided by walls or doors, sprinklers shall be provided on each side of the separation.

8.15.3.2.3 Sprinklers shall be installed beneath landings or stairways where the area beneath is used for storage.

8.15.3.2.4 Sprinklers shall be permitted to be omitted from exterior stair towers when the exterior walls of the stair tower are at least 50 percent open and when the stair tower is entirely of noncombustible construction.

8.15.3.3* Stairs Serving Two or More Fire Divisions. Sprinklers shall be installed in the stair shaft at each floor landing where two or more doors open from that landing into separate fire divisions.

8.15.4* Vertical Openings.

8.15.4.1* General. Unless the requirements of 8.15.4.4 are met, where moving stairways, staircases, or similar floor openings are unenclosed and where sprinkler protection is serving as the alternative to enclosure of the vertical opening, the floor openings involved shall be protected by closely spaced sprinklers in combination with draft stops in accordance with 8.15.4.2 and 8.15.4.3.

8.15.4.2 Draft Stops. Draft stops shall meet all of the following:

- (1) The draft stops shall be located immediately adjacent to the opening.
- (2) The draft stops shall be at least 18 in. (457 mm) deep.
- (3) The draft stops shall be of noncombustible or limited-combustible material that will stay in place before and during sprinkler operation.

8.15.4.3 Sprinklers.

8.15.4.3.1 Sprinklers shall be spaced not more than 6 ft (1.8 m) apart and placed 6 in. to 12 in. (152 mm to 305 mm) from the draft stop on the side away from the opening.

8.15.4.3.2 Where sprinklers are closer than 6 ft (1.8 m), cross baffles shall be provided in accordance with 8.6.3.4.2.

8.15.4.4 Large Openings. Closely spaced sprinklers and draft stops are not required around large openings such as those found in shopping malls, atrium buildings, and similar structures where all adjoining levels and spaces are protected by automatic sprinklers in accordance with this standard and where the openings have all horizontal dimensions between opposite edges of 20 ft (6 m) or greater and an area of 1000 ft² (93 m²) or greater.

8.15.5 Elevator Hoistways and Machine Rooms.

8.15.5.1* Sidewall spray sprinklers shall be installed at the bottom of each elevator hoistway not more than 2 ft (0.61 m) above the floor of the pit.

8.15.5.2 The sprinkler required at the bottom of the elevator hoistway by 8.15.5.1 shall not be required for enclosed, noncombustible elevator shafts that do not contain combustible hydraulic fluids.

8.15.5.3* Automatic sprinklers in elevator machine rooms or at the tops of hoistways shall be of ordinary- or intermediate-temperature rating.

8.15.5.4* Upright, pendent, or sidewall spray sprinklers shall be installed at the top of elevator hoistways.

8.15.5.5 The sprinkler required at the top of the elevator hoistway by 8.15.5.4 shall not be required where the hoistway for passenger elevators is noncombustible and the car enclosure materials meet the requirements of ASME A17.1, *Safety Code for Elevators and Escalators*.

8.15.6 Spaces Under Ground Floors, Exterior Docks, and Platforms.

8.15.6.1 Unless the requirements of 8.15.6.2 are met, sprinklers shall be installed in spaces under all combustible ground floors, exterior docks, and platforms.

8.15.6.2 Sprinklers shall be permitted to be omitted from spaces under ground floors, exterior docks, and platforms where all of the following conditions prevail:

- (1) The space is not accessible for storage purposes and is protected against accumulation of wind-borne debris.

- (2) The space contains no equipment such as conveyors or fuel-fired heating units.
- (3) The floor over the space is of tight construction.
- (4) No combustible or flammable liquids or materials that under fire conditions would convert into combustible or flammable liquids are processed, handled, or stored on the floor above the space.

8.15.7* Exterior Roofs, Canopies, or Porte-Cochere.

8.15.7.1* Unless the requirements of 8.15.7.2, 8.15.7.3, or 8.15.7.4 are met, sprinklers shall be installed under exterior roofs, canopies, or porte-cocheres exceeding 4 ft (1.2 m) in width.

8.15.7.2* Sprinklers shall be permitted to be omitted where the canopy, roof, or porte-cochere is constructed with materials that are noncombustible, limited-combustible, or fire retardant treated wood as defined in NFPA 703, *Standard for Fire Retardant-Treated Wood and Fire-Retardant Coatings for Building Materials*.

8.15.7.3 Sprinklers shall be permitted to be omitted from below the canopy, roof, or porte-cochere of combustible construction, provided the exposed finish material on the roof, canopy, or porte-cochere is noncombustible, limited-combustible, or fire retardant treated wood as defined in NFPA 703, *Standard for Fire Retardant-Treated Wood and Fire-Retardant Coatings for Building Materials*, and the roof, canopy, or porte-cochere contains only sprinklered concealed spaces or any of the following unsprinklered combustible concealed spaces:

- (1) Combustible concealed spaces filled entirely with noncombustible insulation
- (2) Light or ordinary hazard occupancies where noncombustible or limited-combustible ceilings are directly attached to the bottom of solid wood joists so as to create enclosed joist spaces 160 ft³ (4.5 m³) or less in volume, including space below insulation that is laid directly on top or within the ceiling joists in an otherwise sprinklered attic [*See 11.2.3.1.4(4)(d)*].
- (3) Concealed spaces over isolated small roofs, canopies, or porte-cocheres not exceeding 55 ft² (5.1 m²) in area

8.15.7.4 Sprinklers shall be permitted to be omitted from exterior exit corridors when the exterior walls of the corridor are at least 50 percent open and when the corridor is entirely of noncombustible construction.

8.15.7.5* Sprinklers shall be installed under roofs, canopies, or porte-cocheres over areas where combustibles are stored and handled.

8.15.8 Dwelling Units.

8.15.8.1 Bathrooms.

8.15.8.1.1 Unless sprinklers are required by 8.15.8.1.2 or 8.15.8.1.3, sprinklers shall not be required in bathrooms that are located within dwelling units, that do not exceed 55 ft² (5.1 m²) in area, and that have walls and ceilings of noncombustible or limited-combustible materials with a 15-minute thermal barrier rating, including the walls and ceilings behind any

shower enclosure or tub.

8.15.8.1.2 Sprinklers shall be required in bathrooms of limited care facilities and nursing homes, as defined in NFPA 101, *Life Safety Code*.

8.15.8.1.3 Sprinklers shall be required in bathrooms opening directly onto public corridors or exitways.

8.15.8.2* Closets and Pantries. Sprinklers are not required in clothes closets, linen closets, and pantries within dwelling units in hotels and motels where the area of the space does not exceed 24 ft² (2.2 m²), the least dimension does not exceed 3 ft (0.9 m), and the walls and ceilings are surfaced with noncombustible or limited-combustible materials.

8.15.9* Library Stack Areas and Medical Record Storage. Where books or medical records are stored in fixed open book shelves, sprinklers shall be installed in accordance with one of the following:

- (1) Sprinklers shall be permitted to be installed without regard to aisles where there is 18 in. (457 mm) or more clearance between sprinkler deflectors and tops of stacks.
- (2) Where the 18 in. (457 mm) clearance between sprinkler deflectors and tops of stacks cannot be maintained, sprinklers shall be installed in every aisle and at every tier of stacks with distance between sprinklers along aisles not to exceed 12 ft (3.7 m) in accordance with Figure 8.15.9(a).
- (3) Where the 18 in. (457 mm) clearance between sprinkler deflectors and tops of stacks cannot be maintained and where vertical shelf dividers are incomplete and allow water distribution to adjacent aisles, sprinklers shall be permitted to be omitted in alternate aisles on each tier, and where ventilation openings are also provided in tier floors, sprinklers shall be staggered vertically in accordance with Figure 8.15.9(b).

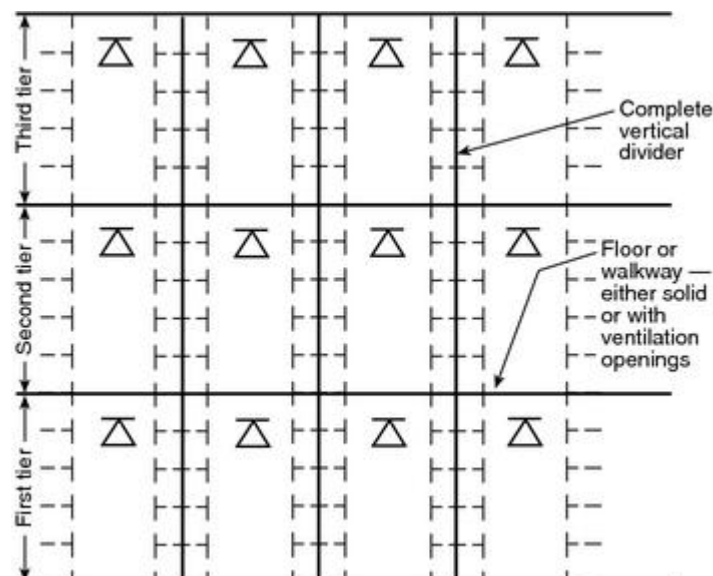

FIGURE 8.15.9(a) Sprinklers in Multitier Bookstacks with Complete Vertical Dividers.

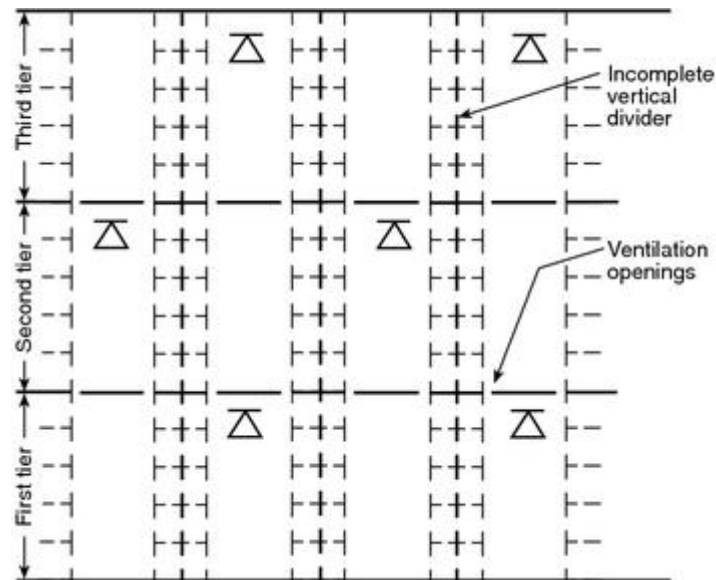

FIGURE 8.15.9(b) Sprinklers in Multitier Bookstacks with Incomplete Vertical Dividers.

8.15.10 Electrical Equipment.

8.15.10.1 Unless the requirements of 8.15.10.3 are met, sprinkler protection shall be required in electrical equipment rooms.

8.15.10.2 Hoods or shields installed to protect important electrical equipment from sprinkler discharge shall be noncombustible.

8.15.10.3 Sprinklers shall not be required in electrical equipment rooms where all of the following conditions are met:

- (1) The room is dedicated to electrical equipment only.
- (2) Only dry-type electrical equipment is used.
- (3) Equipment is installed in a 2-hour fire-rated enclosure including protection for penetrations.
- (4) No combustible storage is permitted to be stored in the room.

8.15.11* Industrial Ovens and Furnaces.

8.15.12 Duct Protection. Duct protection shall be required to meet the requirements of 8.15.12 where required by the authority having jurisdiction or the applicable referenced code or standard.

8.15.12.1 Sprinkler Location.

8.15.12.1.1 Unless the requirements of 8.15.12.1.2 or 8.15.12.1.3 are met, ducts shall have one sprinkler located at the top of each vertical riser and at the midpoint of each offset.

8.15.12.1.2 Sprinklers shall not be required in a vertical riser located outside of a building, provided the riser does not expose combustible material or provided the interior of the

building and the horizontal distance between the hood outlet and the vertical riser is at least 25 ft (7.6 m).

8.15.12.1.3 Horizontal exhaust ducts shall have sprinklers located on 10 ft (3 m) centers beginning no more than 5 ft (1.5 m) from the duct entrance.

8.15.12.2 Protection Against Freezing. Sprinklers in exhaust ducts subject to freezing shall be properly protected against freezing. (*See 8.16.4.1.*)

8.15.12.3 Sprinkler Access. Access shall be provided to all sprinklers for inspection, testing, and maintenance.

8.15.12.4 Strainers. A listed line strainer shall be installed in the main water supply preceding sprinklers having nominal K-factors smaller than K-2.8 (40).

8.15.13* Open-Grid Ceilings. Open-grid ceilings shall only be installed beneath sprinklers where one of the following is met:

- (1) Open-grid ceilings in which the openings are $\frac{1}{4}$ in. (6.4 mm) or larger in the least dimension, where the thickness or depth of the material does not exceed the least dimension of the opening, and where such openings constitute 70 percent of the area of the ceiling material. The spacing of the sprinklers over the open-grid ceiling shall then comply with the following:
 - (a) In light hazard occupancies where sprinkler spacing (either spray or old-style sprinklers) is less than 10 ft \times 10 ft (3 m \times 3 m), a minimum clearance of at least 18 in. (457 mm) shall be provided between the sprinkler deflectors and the upper surface of the open-grid ceiling. Where spacing is greater than 10 ft \times 10 ft (3 m \times 3 m) but less than 10 ft \times 12 ft (3 m \times 3.7 m), a clearance of at least 24 in. (610 mm) shall be provided from spray sprinklers and at least 36 in. (914 mm) from old-style sprinklers. Where spacing is greater than 10 ft \times 12 ft (3 m \times 3.7 m), a clearance of at least 48 in. (1219 mm) shall be provided.
 - (b) In ordinary hazard occupancies, open-grid ceilings shall be permitted to be installed beneath spray sprinklers only. Where sprinkler spacing is less than 10 ft \times 10 ft (3 m \times 3 m), a minimum clearance of at least 24 in. (610 mm) shall be provided between the sprinkler deflectors and the upper surface of the open-grid ceiling. Where spacing is greater than 10 ft \times 10 ft (3 m \times 3 m), a clearance of at least 36 in. (914 mm) shall be provided.
- (2) Other types of open-grid ceilings shall be permitted to be installed beneath sprinklers where they are listed for such service and are installed in accordance with instructions contained in each package of ceiling material.

8.15.14 Drop-Out Ceilings.

8.15.14.1 Drop-out ceilings shall be permitted to be installed beneath sprinklers where ceilings are listed for that service and are installed in accordance with their listings.

8.15.14.2 Drop-out ceilings shall not be installed below quick-response or extended coverage sprinklers unless specifically listed for that application.

8.15.14.3 Drop-out ceilings shall not be considered ceilings within the context of this standard.

8.15.14.4* Piping installed above drop-out ceilings shall not be considered concealed piping.

8.15.14.5* Sprinklers shall not be installed beneath drop-out ceilings.

8.15.15 Old-Style Sprinklers.

8.15.15.1 Unless required by 8.15.15.2 or 8.15.15.3, old-style sprinklers shall not be used in a new installation.

8.15.15.2* Old-style sprinklers shall be installed in fur storage vaults.

8.15.15.3 Use of old-style sprinklers shall be permitted where construction features or other special situations require unique water distribution.

8.15.16 Stages.

8.15.16.1 Sprinklers shall be installed under the roof at the ceiling, in spaces under the stage either containing combustible materials or constructed of combustible materials, and in all adjacent spaces and dressing rooms, storerooms, and workshops.

8.15.16.2 Where proscenium opening protection is required, a deluge system shall be provided with open sprinklers located not more than 3 ft (0.9 m) away from the stage side of the proscenium arch and spaced up to a maximum of 6 ft (1.8 m) on center. *(See Chapter 11 for design criteria.)*

8.15.17 Stair Towers. Stairs, towers, or other construction with incomplete floors, if piped on independent risers, shall be treated as one area with reference to pipe sizes.

8.15.18 Return Bends.

8.15.18.1 Unless the requirements of 8.15.18.3 or 8.15.18.4 are met, return bends shall be used where pendent sprinklers are supplied from a raw water source, a mill pond, or open-top reservoirs.

8.15.18.2 Return bends shall be connected to the top of branch lines in order to avoid accumulation of sediment in the drop nipples in accordance with Figure 8.15.18.2.

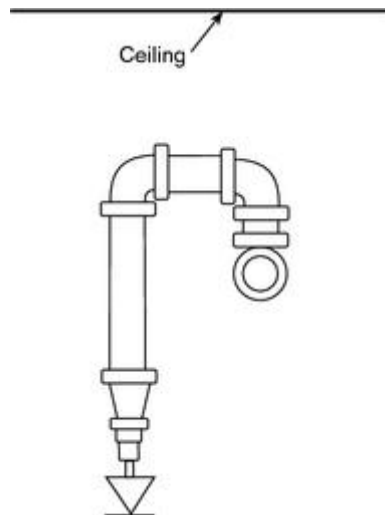

FIGURE 8.15.18.2 Return Bend Arrangement.

8.15.18.3 Return bends shall not be required for deluge systems.

8.15.18.4 Return bends shall not be required where dry-pendent sprinklers are used.

8.15.19 Piping to Sprinklers Below Ceilings.

8.15.19.1* In new installations expected to supply sprinklers below a ceiling, minimum 1 in. (25 mm) outlets shall be provided.

8.15.19.2* In new installations, it shall be permitted to provide minimum 1 in. (25 mm) outlets with hexagonal bushings to accommodate sprinklers attached directly to branch line fittings to allow for future system modifications.

8.15.19.3 When systems are revamped to accommodate added ceilings, sprinkler outlets utilized for new armover or drop nipples shall have hexagonal bushings removed.

8.15.19.4 Revamping of Pipe Schedule Systems.

8.15.19.4.1 When pipe schedule systems are revamped, a nipple not exceeding 4 in. (100 mm) in length shall be permitted to be installed in the branch line fitting.

8.15.19.4.2 All piping other than the nipple permitted in 8.15.19.4.1 and 8.15.19.4.3 shall be a minimum of 1 in. (25 mm) in diameter in accordance with Figure 8.15.19.4.2.

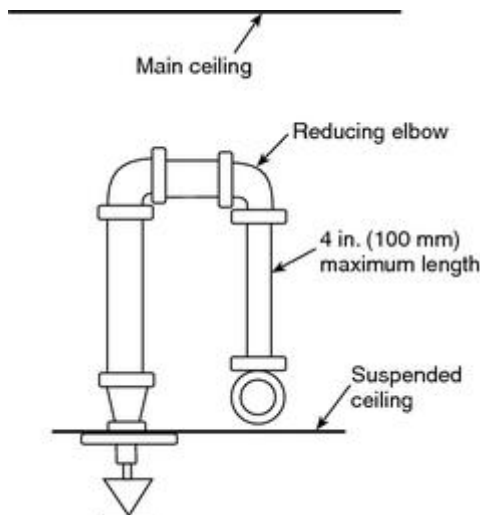

FIGURE 8.15.19.4.2 Nipple and Reducing Elbow Supplying Sprinkler Below Ceiling.

8.15.19.4.3 When it is necessary to pipe two new ceiling sprinklers from an existing outlet in an overhead system, the use of a nipple not exceeding 4 in. (100 mm) in length and of the same pipe thread size as the existing outlet shall be permitted, provided that a hydraulic calculation verifies that the design flow rate will be achieved in accordance with Figure 8.15.19.4.3.

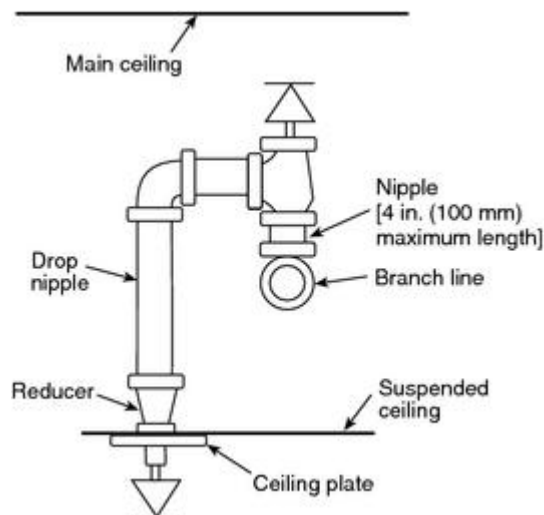

FIGURE 8.15.19.4.3 Sprinklers in Concealed Space and Below Ceiling.

8.15.19.4.4 The use of pipe nipples less than 1 in. (25 mm) in diameter shall not be permitted in areas subject to earthquakes.

8.15.19.5 Revamping of Hydraulic Design Systems.

8.15.19.5.1 When hydraulically designed systems are revamped, any existing bushing shall be removed and a nipple not exceeding 4 in. (100 mm) in length shall be permitted to be installed in the branch line fitting.

8.15.19.5.2 Calculations shall be provided to verify that the system design flow rate will be

achieved.

8.15.19.5.3 When it is necessary to pipe two new ceiling sprinklers from an existing outlet in an overhead system, any bushings shall be removed and the use of a nipple not exceeding 4 in. (100 mm) in length and of the same pipe thread size as the existing outlet shall be permitted, provided that a hydraulic calculation verifies that the design flow rate will be achieved.

8.15.19.5.4 The use of pipe nipples less than 1 in. (25 mm) in diameter is not permitted in areas subject to earthquakes.

8.15.20 Dry Pipe Underground.

8.15.20.1 Where necessary to place pipe that will be under air pressure underground, the pipe shall be protected against corrosion.

8.15.20.2 Unprotected cast-iron or ductile-iron pipe shall be permitted where joined with a gasketed joint listed for air service underground.

8.15.21* System Subdivision. Where individual floor/zone control valves are not provided, a flanged joint or mechanical coupling shall be used at the riser at each floor for connections to piping serving floor areas in excess of 5000 ft² (465 m²).

8.15.22 Spaces Above Ceilings.

8.15.22.1 Where spaces have ceilings that are lower than the rest of the area, the space above this lower ceiling shall be sprinklered unless it complies with the rules of 8.15.1.2 for allowable unsprinklered concealed spaces.

8.15.22.2 Where the space above a drop ceiling is sprinklered, the sprinkler system shall conform to the rules of Section 12.3.

8.16 Piping Installation.

8.16.1 Valves.

8.16.1.1* Control Valves.

8.16.1.1.1* General.

8.16.1.1.1.1 Each sprinkler system shall be provided with a listed indicating valve in an accessible location, so located as to control all automatic sources of water supply.

8.16.1.1.1.2 At least one listed indicating valve shall be installed in each source of water supply.

8.16.1.1.1.3 The requirements of 8.16.1.1.1.2 shall not apply to the fire department connection, and there shall be no shutoff valve in the fire department connection.

8.16.1.1.2* Supervision.

8.16.1.1.2.1 Valves on connections to water supplies, sectional control and isolation valves, and other valves in supply pipes to sprinklers and other fixed water-based fire suppression systems shall be supervised by one of the following methods:

- (1) Central station, proprietary, or remote station signaling service
- (2) Local signaling service that will cause the sounding of an audible signal at a constantly attended point
- (3) Valves locked in the correct position
- (4) Valves located within fenced enclosures under the control of the owner, sealed in the open position, and inspected weekly as part of an approved procedure

8.16.1.1.2.2 Floor control valves in high-rise buildings and valves controlling flow to sprinklers in circulating closed loop systems shall comply with 8.16.1.1.2.1(1) or 8.16.1.1.2.1(2).

8.16.1.1.2.3 The requirements of 8.16.1.1.2.1 shall not apply to underground gate valves with roadway boxes.

8.16.1.1.2.4 Where control valves are installed overhead, they shall be positioned so that the indicating feature is visible from the floor below.

8.16.1.1.3* Check Valves.

8.16.1.1.3.1 Where there is more than one source of water supply, a check valve shall be installed in each connection.

8.16.1.1.3.2 A listed backflow prevention device shall be considered a check valve, and an additional check valve shall not be required.

8.16.1.1.3.3 Where cushion tanks are used with automatic fire pumps, no check valve is required in the cushion tank connection.

8.16.1.1.3.4 Check valves shall be installed in a vertical or horizontal position in accordance with their listing.

8.16.1.1.3.5* Where a single wet pipe sprinkler system is equipped with a fire department connection, the alarm valve is considered a check valve, and an additional check valve shall not be required.

8.16.1.1.4* Control Valves with Check Valves.

8.16.1.1.4.1 In a connection serving as one source of supply, listed indicating valves or post-indicator valves shall be installed on both sides of all check valves required in 8.16.1.1.3. The city services control valve (non-indicating control valve) shall be permitted to serve as the supply side control valve.

8.16.1.1.4.2 The requirements of 8.16.1.1.4.1 shall not apply to the check valve located in the fire department connection piping, and there shall be no control valves in the fire department connection piping.

8.16.1.1.4.3 The requirements of 8.16.1.1.4.1 shall not apply where the city connection serves as the only automatic source of supply to a wet pipe sprinkler system; a control valve is not required on the system side of the check valve or the alarm check valve.

8.16.1.1.5* Control Valves for Gravity Tanks.

8.16.1.1.5.1 Gravity tanks shall have listed indicating valves installed on both sides of the check valve.

8.16.1.1.6* Pumps. When a pump is located in a combustible pump house or exposed to danger from fire or falling walls, or when a tank discharges into a private fire service main fed by another supply, either the check valve in the connection shall be located in a pit or the control valve shall be of the post-indicator type located a safe distance outside buildings.

8.16.1.1.7* Control Valve Accessibility. All control valves shall be located where readily accessible and free of obstructions.

8.16.1.1.8 Control Valve Identification. Identification signs shall be provided at each valve to indicate its function and what it controls.

8.16.1.2 Pressure-Reducing Valves.

8.16.1.2.1 In portions of systems where all components are not listed for pressure greater than 175 psi (12.1 bar) and the potential exists for normal (nonfire condition) water pressure in excess of 175 psi (12.1 bar), a listed pressure-reducing valve shall be installed and set for an outlet pressure not exceeding 165 psi (2.4 bar) at the maximum inlet pressure.

8.16.1.2.2 Pressure gauges shall be installed on the inlet and outlet sides of each pressure-reducing valve.

8.16.1.2.3* A relief valve of not less than ½ in. (13 mm) in size shall be provided on the discharge side of the pressure-reducing valve set to operate at a pressure not exceeding 175 psi (12.1 bar).

8.16.1.2.4 A listed indicating valve shall be provided on the inlet side of each pressure-reducing valve, unless the pressure-reducing valve meets the listing requirements for use as an indicating valve.

8.16.1.2.5 Means shall be provided downstream of all pressure-reducing valves for flow tests at sprinkler system demand.

8.16.1.3* Post-Indicator Valves.

8.16.1.3.1 Post-indicator valves shall be set so that the top of the post will be 36 in. (0.9 m) above the final grade.

8.16.1.3.2 Post-indicator valves shall be properly protected against mechanical damage where needed.

8.16.1.4 Valves in Pits.

8.16.1.4.1 General. Where it is impractical to provide a post-indicator valve, valves shall be permitted to be placed in pits with permission of the authority having jurisdiction.

8.16.1.4.2* Valve Pit Construction.

8.16.1.4.2.1 When used, valve pits shall be of adequate size and readily accessible for

Copyright NFPA

inspection, operation, testing, maintenance, and removal of equipment contained therein.

8.16.1.4.2.2 Valve pits shall be constructed and arranged to properly protect the installed equipment from movement of earth, freezing, and accumulation of water.

8.16.1.4.2.3 Poured-in-place or precast concrete, with or without reinforcement, or brick (all depending upon soil conditions and size of pit) shall be appropriate materials for construction of valve pits.

8.16.1.4.2.4 Other approved materials shall be permitted to be used for valve pit construction.

8.16.1.4.2.5 Where the water table is low and the soil is porous, crushed stone or gravel shall be permitted to be used for the floor of the pit. [See Figure A.8.17.2(b) for a suggested arrangement.]

8.16.1.4.2.6 Valve pits located at or near the base of the riser of an elevated tank shall be designed in accordance with Chapter 9 of NFPA 22, *Standard for Water Tanks for Private Fire Protection*.

8.16.1.4.3 Valve Pit Marking. The location of the valve shall be clearly marked, and the cover of the pit shall be kept free of obstructions.

8.16.1.5 Sectional Valves.

8.16.1.5.1 Large private fire service main systems shall have sectional controlling valves at appropriate points in order to permit sectionalizing the system in the event of a break or for the making of repairs or extensions.

8.16.1.5.2 A valve shall be provided on each bank where a main crosses water and outside the building foundation(s) where the main or section of main runs under a building.

8.16.1.6* In-Rack Sprinkler System Control Valves.

8.16.1.6.1 Unless the requirements of 8.16.1.6.2 or 8.16.1.6.3 are met, where sprinklers are installed in racks, separate indicating control valves and drains shall be provided and arranged so that ceiling and in-rack sprinklers can be controlled independently.

8.16.1.6.2 Installation of 20 or fewer in-rack sprinklers supplied by any one ceiling sprinkler system shall not require a separate indicating control valve.

8.16.1.6.3 The separate indicating valves shall be permitted to be arranged as sectional control valves where the racks occupy only a portion of the area protected by the ceiling sprinklers.

8.16.2 Drainage.

8.16.2.1* General. All sprinkler pipe and fittings shall be so installed that the system can be drained.

8.16.2.2 Wet Pipe Systems.

8.16.2.2.1 On wet pipe systems, sprinkler pipes shall be permitted to be installed level.

8.16.2.2.2 Trapped piping shall be drained in accordance with 8.16.2.5.

8.16.2.3 Dry Pipe and Preaction Systems. Piping shall be pitched to drain as stated in 8.16.2.3.1 through 8.16.2.3.3.

8.16.2.3.1 Dry Pipe Systems in Non-Refrigerated Areas. In dry pipe systems branch lines shall be pitched at least ½ in. per 10 ft (4 mm/m) and mains shall be pitched at least ¼ in. per 10 ft (2 mm/m).

8.16.2.3.2 Preaction Systems. In preaction systems, branch lines shall be pitched at least ½ in. per 10 ft (4 mm/m) and mains shall be pitched at least ¼ in. per 10 ft (2 mm/m).

8.16.2.3.3 Dry Pipe and Preaction Systems in Refrigerated Areas. Branch lines shall be pitched at least ½ in. per 10 ft (4 mm/m), and mains shall be pitched at least ½ in. per 10 ft (4 mm/m) in refrigerated areas.

8.16.2.4* System, Main Drain, or Sectional Drain Connections. See Figure 8.16.2.4.

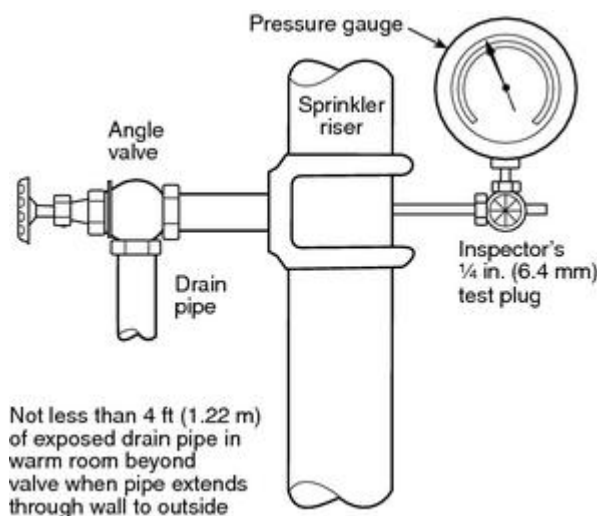

FIGURE 8.16.2.4 Drain Connection for System Riser.

8.16.2.4.1* Provisions shall be made to properly drain all parts of the system.

8.16.2.4.2 Drain connections for systems supply risers and mains shall be sized as shown in Table 8.16.2.4.2.

Table 8.16.2.4.2 Drain Size

Riser or Main Size	Size of Drain Connection
Up to 2 in.	¾ in. or larger
2½ in., 3 in., 3½ in.	1¼ in. or larger
4 in. and larger	2 in. only

For SI units, 1 in. = 25.4 mm.

8.16.2.4.3 Where an interior sectional or floor control valve(s) is provided, it shall be

provided with a drain connection having a minimum size as shown in Table 8.16.2.4.2 to drain that portion of the system controlled by the sectional valve.

8.16.2.4.4 Drains shall discharge outside or to a drain connection capable of handling the flow of the drain. [See Figure A.8.17.4.2(b).]

8.16.2.4.5 For those drains serving pressure-reducing valves, the drain, drain connection, and all other downstream drain piping shall be sized to permit a flow of at least the greatest system demand supplied by the pressure-reducing valve.

8.16.2.4.6 The test connections required by 8.17.4.1 shall be permitted to be used as main drain connections.

8.16.2.4.7 Where drain connections for floor control valves are tied into a common drain riser, the drain riser shall be one pipe size larger than the largest size drain connection tying into it.

8.16.2.5 Auxiliary Drains.

8.16.2.5.1 Auxiliary drains shall be provided where a change in piping direction prevents drainage of system piping through the main drain valve.

8.16.2.5.2 Auxiliary Drains for Wet Pipe Systems and Preaction Systems in Areas Not Subject to Freezing.

8.16.2.5.2.1* Where the capacity of isolated trapped sections of pipe is 50 gal (189 L) or more, the auxiliary drain shall consist of a valve not smaller than 1 in. (25 mm), piped to an accessible location.

8.16.2.5.2.2 Where the capacity of isolated trapped sections of pipe is more than 5 gal (18.9 L) and less than 50 gal (189 L), the auxiliary drain shall consist of a valve $\frac{3}{4}$ in. (20 mm) or larger and a plug or a nipple and cap.

8.16.2.5.2.3 Where the capacity of trapped sections of pipes in wet systems is less than 5 gal (18.9 L), one of the following arrangements shall be provided:

- (1) An auxiliary drain shall consist of a nipple and cap or plug not less than $\frac{1}{2}$ in. (15 mm) in size.
- (2) An auxiliary drain shall not be required for trapped sections less than 5 gal (18.9 L) where the system piping can be drained by removing a single pendent sprinkler.
- (3) Where flexible couplings or other easily separated connections are used, the nipple and cap or plug shall be permitted to be omitted.

8.16.2.5.2.4 Tie-in drains shall not be required on wet pipe systems and preaction systems protecting non-freezing environments.

8.16.2.5.3 Auxiliary Drains for Dry Pipe Systems and Preaction Systems.

8.16.2.5.3.1 Auxiliary drains located in areas subject to freezing shall be readily accessible.

8.16.2.5.3.2 Where the capacity of trapped sections of pipe is less than 5 gal (18.9 L), the auxiliary drain shall consist of a valve not smaller than $\frac{1}{2}$ in. (15 mm) and a plug or a nipple

and cap.

8.16.2.5.3.3 Auxiliary drains are not for pipe drops supplying dry-pendent sprinklers installed in accordance with 7.2.2.

8.16.2.5.3.4 Where the capacity of isolated trapped sections of system piping is more than 5 gal (18.9 L), the auxiliary drain shall consist of two 1 in. (25 mm) valves and one 2 in. × 12 in. (50 mm × 305 mm) condensate nipple or equivalent, accessibly located in accordance with Figure 8.16.2.5.3.4.

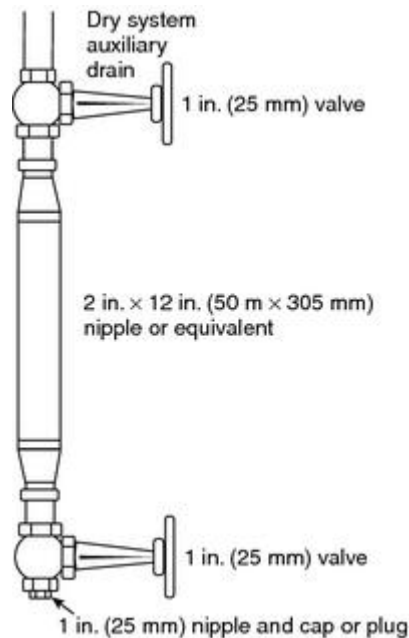

FIGURE 8.16.2.5.3.4 Dry System Auxiliary Drain.

8.16.2.5.3.5 Tie-in drains shall be provided for multiple adjacent trapped branch pipes and shall be only 1 in. (25 mm). Tie-in drain lines shall be pitched a minimum of ½ in. per 10 ft (4 mm/m).

8.16.2.5.3.6 Systems with low point drains shall have a sign at the dry pipe or preaction valve indicating the number of low point drains and the location of each individual drain.

8.16.2.6 Discharge of Drain Valves.

8.16.2.6.1* Direct interconnections shall not be made between sprinkler drains and sewers.

8.16.2.6.2 The drain discharge shall conform to any health or water department regulations.

8.16.2.6.3 Where drain pipes are buried underground, approved corrosion-resistant pipe shall be used.

8.16.2.6.4 Drain pipes shall not terminate in blind spaces under the building.

8.16.2.6.5 Where exposed to the atmosphere, drain pipes shall be fitted with a turned-down elbow.

8.16.2.6.6 Drain pipes shall be arranged to avoid exposing any part of the sprinkler system

to freezing conditions.

8.16.3 Provision for Flushing Systems.

8.16.3.1 All sprinkler systems shall be arranged for flushing.

8.16.3.2 Readily removable fittings shall be provided at the end of all cross mains.

8.16.3.3 All cross mains shall terminate in 1¼ in. (32 mm) or larger pipe.

8.16.3.4 All branch lines on gridded systems shall be arranged to facilitate flushing.

8.16.4 Protection of Piping.

8.16.4.1 Protection of Piping Against Freezing.

8.16.4.1.1 Unless the requirements of 8.16.4.1.2 are met, where portions of systems are subject to freezing and temperatures cannot reliably be maintained at or above 40°F (4°C), sprinklers shall be installed as a dry pipe or preaction system.

8.16.4.1.2 Small unheated areas are permitted to be protected by antifreeze systems or by other systems specifically listed for this purpose, including but not limited to listed heat tracing systems.

8.16.4.1.3 Where aboveground water-filled supply pipes, risers, system risers, or feed mains pass through open areas, cold rooms, passageways, or other areas exposed to temperatures below 40°F (4°C), the pipe shall be protected against freezing by insulating coverings, frostproof casings, listed heat tracing systems, or other reliable means capable of maintaining a minimum temperature between 40°F (4°C) and 120°F (48.9°C).

8.16.4.1.4 Where listed heat tracing systems are used, they shall be supervised.

8.16.4.1.5 Where listed heat tracing is utilized for branch lines, it shall be specifically listed for use on branch lines.

8.16.4.2 Protection of Piping Against Corrosion.

8.16.4.2.1* Where corrosive conditions are known to exist due to moisture or fumes from corrosive chemicals or both, special types of fittings, pipes, and hangers that resist corrosion shall be used, or a protective coating shall be applied to all unprotected exposed surfaces of the sprinkler system.

8.16.4.2.2 Where water supplies or environmental conditions are known to have unusual corrosive properties, piping shall have a corrosion resistance ratio (CRR) of 1 or more and the system shall be treated in accordance with 23.1.5.

8.16.4.2.3 Where corrosive conditions exist or piping is exposed to the weather, corrosion-resistant types of pipe, fittings, and hangers or protective corrosion-resistant coatings shall be used.

8.16.4.2.4 Where steel pipe is used underground, the pipe shall be protected against corrosion.

8.16.4.3 Protection of Piping in Hazardous Areas.

8.16.4.3.1 Private service main aboveground piping shall not pass through hazardous areas and shall be located so that it is protected from mechanical and fire damage.

8.16.4.3.2 Private service main aboveground piping shall be permitted to be located in hazardous areas protected by an automatic sprinkler system.

8.16.5 Protection of Risers Subject to Mechanical Damage. Sprinkler risers subject to mechanical damage shall be protected by steel posts, concrete barriers, or other approved means.

8.17 System Attachments.

8.17.1* Sprinkler Alarms/Waterflow Alarms.

8.17.1.1 Local Waterflow Alarms. A local waterflow alarm shall be provided on every sprinkler system having more than 20 sprinklers.

8.17.1.2 Retarding Devices.

8.17.1.2.1 On each alarm check valve used under conditions of variable water pressure, a retarding device shall be installed.

8.17.1.3 Alarm Bypass Test Connections.

8.17.1.3.1 Alarm, dry pipe, preaction, and deluge valves shall be fitted with an alarm bypass test connection for an electric alarm switch, water motor gong, or both.

8.17.1.3.2 The alarm bypass test connection for alarm, dry pipe, preaction, and deluge valves shall be made on the water supply side of the system and provided with a control valve and drain for the alarm piping.

8.17.1.3.3 The alarm bypass test connection for alarm valves at the riser shall be permitted to be made on the system side of an alarm valve.

8.17.1.3.4 A check valve shall be installed between the intermediate chamber of a dry pipe valve and the waterflow alarm device so as to prevent flow from the alarm bypass test connection from entering the intermediate chamber of a dry pipe valve during an alarm test via the alarm bypass test connection.

8.17.1.4 Indicating Control Valves.

8.17.1.4.1 An indicating control valve shall be installed in the connection to pressure-type contactors or water motor-operated alarm devices.

8.17.1.4.2 Such valves shall be sealed, locked, or electrically supervised in the open position.

8.17.1.4.3 The control valve for the retarding chamber on alarm check valves shall be accepted as complying with the requirements of 8.17.1.4.

8.17.1.5* Attachments — Mechanically Operated.

8.17.1.5.1 For all types of sprinkler systems employing water motor-operated alarms, a

listed $\frac{3}{4}$ in. (20 mm) strainer shall be installed at the alarm outlet of the waterflow detecting device.

8.17.1.5.2 Where a retarding chamber is used in connection with an alarm valve, the strainer shall be located at the outlet of the retarding chamber unless the retarding chamber is provided with an approved integral strainer in its outlet.

8.17.1.6* Alarm Attachments — High-Rise Buildings. When a fire must be fought internally due to the height of a building, the following additional alarm apparatus shall be provided:

- (1) Where each sprinkler system on each floor is equipped with a separate waterflow device, it shall be connected to an alarm system in such a manner that operation of one sprinkler will actuate the alarm system, and the location of the operated flow device shall be indicated on an annunciator and/or register. The annunciator or register shall be located at grade level at the normal point of fire department access, at a constantly attended building security control center, or at both locations.
- (2) Where the location within the protected buildings where supervisory or alarm signals are received is not under constant supervision by qualified personnel in the employ of the owner, a connection shall be provided to transmit a signal to a remote central station.
- (3) A distinct trouble signal shall be provided to indicate a condition that will impair the satisfactory operation of the sprinkler system.

8.17.1.7 Sprinkler Waterflow Alarm for In-Rack Sprinklers. See Section C.4.

8.17.2* Fire Department Connections.

8.17.2.1* Unless the requirements of 8.17.2.2 are met, a fire department connection shall be provided as described in 8.17.2 in accordance with Figure 8.17.2.1.

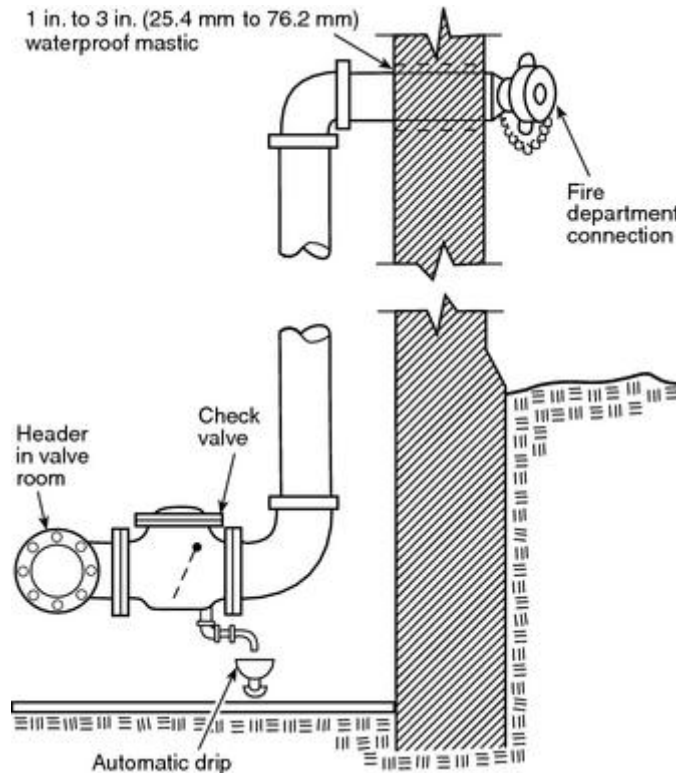

FIGURE 8.17.2.1 Fire Department Connections.

8.17.2.2 The following systems shall not require a fire department connection:

- (1) Buildings located in remote areas that are inaccessible for fire department support
- (2) Large-capacity deluge systems exceeding the pumping capacity of the fire department
- (3) Single-story buildings not exceeding 2000 ft² (186 m²) in area

8.17.2.3* Size. The size of the pipe for the fire department connection shall be in accordance with one of the following:

- (1) Pipe size shall be a minimum of 4 in. (100 mm) for fire engine connections.
- (2) Pipe size shall be a minimum of 6 in. (150 mm) for fire boat connections.
- (3) For hydraulically calculated systems, the fire department connection shall be permitted to be less than 4 in. (100 mm) and no less than the size of system riser, where serving one system riser.

8.17.2.4* Arrangement. See Figure 8.17.2.1.

8.17.2.4.1* The fire department connection shall be on the system side of the water supply check valve.

8.17.2.4.1.1 The fire department connection shall not be attached to branch line piping.

8.17.2.4.1.2 The fire department connection shall be permitted to be connected to main

| piping on the system it serves.

8.17.2.4.2 For single systems, the fire department connection shall be installed as follows:

- (1) Wet system — on the system side of system control, check, and alarm valves (*see Figure A.8.16.1.1*)
- (2) Dry system — between the system control valve and the dry pipe valve
- (3) Preaction system — between the preaction valve and the check valve on the system side of the preaction valve
- (4) Deluge system — on the system side of the deluge valve

8.17.2.4.3 For multiple systems, the fire department connection shall be connected between the supply control valves and the system control valves.

8.17.2.4.4 The requirements of 8.17.2.4.2 and 8.17.2.4.3 shall not apply where the fire department connection is connected to the underground piping.

8.17.2.4.5 Where a fire department connection services only a portion of a building, a sign shall be attached indicating the portions of the building served.

8.17.2.4.6 Unless otherwise directed by the authority having jurisdiction, fire department connections shall be on the street side of buildings and shall be located and arranged so that hose lines can be readily and conveniently attached to the inlets without interference from any nearby objects, including buildings, fences, posts, or other fire department connections. The location shall be based on the requirements of the fire department.

8.17.2.4.7 Signs.

8.17.2.4.7.1 Each fire department connection to sprinkler systems shall be designated by a sign having raised or engraved letters at least 1 in. (25.4 mm) in height on plate or fitting reading service design — for example, AUTOSPKR., OPEN SPKR., AND STANDPIPE.

8.17.2.4.7.2 A sign shall also indicate the pressure required at the inlets to deliver the greatest system demand.

8.17.2.4.7.3 The sign required in 8.17.2.4.7.2 shall not be required where the system demand pressure is less than 150 psi (10.3 bar).

8.17.2.4.8 Fire department connections shall not be connected on the suction side of fire pumps.

8.17.2.4.9 Fire department connections shall be properly supported.

8.17.2.5 Valves.

8.17.2.5.1 A listed check valve shall be installed in each fire department connection.

8.17.2.5.2 There shall be no shutoff valve in the fire department connection piping.

8.17.2.6 Drainage. The piping between the check valve and the outside hose coupling shall be equipped with an approved automatic drip in areas subject to freezing.

8.17.3 Gauges.

8.17.3.1 A pressure gauge with a connection not smaller than ¼ in. (6 mm) shall be installed at the system main drain, at each main drain associated with a floor control valve, and on the inlet and outlet side of each pressure-reducing valve.

8.17.3.2 Each gauge connection shall be equipped with a shutoff valve and provisions for draining.

8.17.3.3 The required pressure gauges shall be listed and shall have a maximum limit not less than twice the normal system working pressure at the point where installed.

8.17.3.4 Gauges shall be installed to permit removal and shall be located where they will not be subject to freezing.

8.17.4 System Connections.

8.17.4.1* Main Drain Test Connections.

8.17.4.1.1 Main drain test connections shall be provided at locations that will permit flow tests of water supplies and connections.

8.17.4.1.2 They shall be so installed that the valve can be opened wide for a sufficient time to assure a proper test without causing water damage.

8.17.4.1.3 Main drain connections shall be sized in accordance with 8.16.2.4 and 8.16.2.6.

8.17.4.2* Wet Pipe Systems.

8.17.4.2.1 An alarm test connection not less than 1 in. (25 mm) in diameter, terminating in a smooth bore corrosion-resistant orifice, giving a flow equal to or less than one sprinkler of a type having the smallest orifice installed on the particular system, shall be provided to test each waterflow alarm device for each system.

8.17.4.2.2 The test connection valve shall be readily accessible.

8.17.4.2.3 The discharge shall be to the outside, to a drain connection capable of accepting full flow under system pressure, or to another location where water damage will not result.

8.17.4.2.4 The alarm test connection shall be permitted to be installed in any location on the fire sprinkler system downstream of the waterflow alarm.

8.17.4.3* Dry Pipe Systems.

8.17.4.3.1 A trip test connection not less than 1 in. (25 mm) in diameter, terminating in a smooth bore corrosion-resistant orifice, to provide a flow equivalent to one sprinkler of a type installed on the particular system, shall be installed.

8.17.4.3.2 The trip test connection shall be located on the end of the most distant sprinkler pipe in the upper story and shall be equipped with a readily accessible shutoff valve and plug not less than 1 in. (25 mm), at least one of which shall be brass.

8.17.4.3.3 In lieu of a plug, a nipple and cap shall be acceptable.

8.17.4.4 Preaction Systems.

8.17.4.4.1 A test connection shall be provided on a preaction system using supervisory air.

8.17.4.4.2 The connection used to control the level of priming water shall be considered adequate to test the operation of the alarms monitoring the supervisory air pressure.

8.17.4.4.3 For double interlock preaction systems in excess of 750 gal (2840 L), a trip test connection not less than 1 in. (25 mm) in diameter, terminating in a smooth bore corrosion-resistant orifice to provide a flow equivalent to one sprinkler of a type installed on the particular system, shall be installed.

8.17.4.4.4 For double interlock preaction systems in excess of 750 gal (2840 L), the trip test connection shall be located on the end of the most distant sprinkler pipe in the upper story and shall be equipped with a readily accessible shutoff valve and plug not less than 1 in. (25 mm), at least one of which shall be brass.

8.17.4.5 Deluge Systems. A test connection is not required on a deluge system.

8.17.4.6* Backflow Devices.

8.17.4.6.1* Backflow Prevention Valves. Means shall be provided downstream of all backflow prevention valves for flow tests at system demand.

8.17.4.6.2 Retroactive Installation. When backflow prevention devices are to be retroactively installed on existing systems, a thorough hydraulic analysis, including revised hydraulic calculations, new fire flow data, and all necessary system modifications to accommodate the additional friction loss, shall be completed as a part of the installation.

8.17.5 Hose Connections.

8.17.5.1 Small (1½ in.) (38 mm) Hose Connections. See Section C.5.

8.17.5.1.1* Where required, small (1½ in.) hose connections shall be installed. Valves shall be available to reach all portions of the area with 100 ft (30.5 m) of hose plus 30 ft (9.1 m) of hose stream distance.

8.17.5.1.1.1 Where the building is protected throughout by an approved automatic sprinkler system, the presence of 1½ in. (40 mm) hose lines for use by the building occupants shall not be required, subject to the approval of the authority having jurisdiction.

8.17.5.1.2 The hose connections shall not be required to meet the requirements of Class II hose systems defined by NFPA 14, *Standard for the Installation of Standpipe and Hose Systems*.

8.17.5.1.3 Hose connections shall be supplied from one of the following:

- (1) Outside hydrants
- (2) A separate piping system for small hose connections
- (3) Valved hose connections on sprinkler risers where such connections are made upstream of all sprinkler control valves

- (4) Adjacent sprinkler systems
- (5) In rack storage areas, the ceiling sprinkler system in the same area (as long as in-rack sprinklers are provided in the same area and are separately controlled)

8.17.5.1.4* Hose connections used for fire purposes only shall be permitted to be connected to wet sprinkler systems only, subject to the following restrictions:

- (1) Hose connection's supply pipes shall not be connected to any pipe smaller than 2½ in. (65 mm) in diameter.
- (2) The requirements of 8.17.5.1.4(1) shall not apply to hydraulically designed loops and grids, where the minimum size pipe between the hose connection's supply pipe and the source shall be permitted to be 2 in. (51 mm).
- (3) For piping serving a single hose connection, pipe shall be a minimum of 1 in. (25.4 mm) for horizontal runs up to 20 ft (6.1 m), a minimum of 1¼ in. (33 mm) for the entire run for runs between 20 ft and 80 ft (6.1 m and 24.4 m), and a minimum of 1½ in. (38 mm) for the entire run for runs greater than 80 ft (24.4 m). For piping serving multiple hose connections, runs shall be a minimum of 1½ in. (38 mm) throughout.
- (4) Piping shall be at least 1 in. (25 mm) for vertical runs.
- (5) When the pressure at any hose connection outlet exceeds 100 psi (6.9 bar), an approved device shall be installed at the outlet to reduce the pressure at the outlet to 100 psi (6.9 bar).

8.17.5.2 Hose Connections for Fire Department Use.

8.17.5.2.1 In buildings of light or ordinary hazard occupancy, 2½ in. (64 mm) hose valves for fire department use shall be permitted to be attached to wet pipe sprinkler system risers.

8.17.5.2.2* The following restrictions shall apply:

- (1) Each connection from a standpipe that is part of a combined system to a sprinkler system shall have an individual control valve and check valve of the same size as the connection.
- (2) The minimum size of the riser shall be 4 in. (102 mm) unless hydraulic calculations indicate that a smaller size riser will satisfy sprinkler and hose stream allowances.
- (3) Each combined sprinkler and standpipe riser shall be equipped with a riser control valve to permit isolating a riser without interrupting the supply to other risers from the same source of supply. *(For fire department connections serving standpipe and sprinkler systems, refer to Section 6.8.)*

Chapter 9 Hanging, Bracing, and Restraint of System Piping

9.1 Hangers.

9.1.1* General.

Copyright NFPA

9.1.1.1 Unless the requirements of 9.1.1.2 are met, types of hangers shall be in accordance with the requirements of Section 9.1.

9.1.1.2 Hangers certified by a registered professional engineer to include all of the following shall be an acceptable alternative to the requirements of Section 9.1:

- (1) Hangers shall be designed to support five times the weight of the water-filled pipe plus 250 lb (114 kg) at each point of piping support.
- (2) These points of support shall be adequate to support the system.
- (3) The spacing between hangers shall not exceed the value given for the type of pipe as indicated in Table 9.2.2.1(a) or Table 9.2.2.1(b).
- (4) Hanger components shall be ferrous.
- (5) Detailed calculations shall be submitted, when required by the reviewing authority, showing stresses developed in hangers, piping, and fittings and safety factors allowed.

9.1.1.3 Where water-based fire protection systems are required to be protected against damage from earthquakes, hangers shall also meet the requirements of 9.3.7.

9.1.1.4 Listing.

9.1.1.4.1 Unless permitted by 9.1.1.4.2 or 9.1.1.4.3, the components of hanger assemblies that directly attach to the pipe or to the building structure shall be listed.

9.1.1.4.2* Mild steel hangers formed from rods shall be permitted to be not listed.

9.1.1.4.3* Fasteners as specified in 9.1.3, 9.1.4, and 9.1.5 shall be permitted to be not listed.

9.1.1.4.4 Other fasteners shall be permitted as part of a hanger assembly that has been tested, listed, and installed in accordance with the listing requirements.

9.1.1.5 Component Material.

9.1.1.5.1 Unless permitted by 9.1.1.5.2 or 9.1.1.5.3, hangers and their components shall be ferrous.

9.1.1.5.2 Nonferrous components that have been proven by fire tests to be adequate for the hazard application, that are listed for this purpose, and that are in compliance with the other requirements of this section shall be acceptable.

9.1.1.5.3 Holes through solid structural members shall be permitted to serve as hangers for the support of system piping provided such holes are permitted by applicable building codes and the spacing and support provisions for hangers of this standard are satisfied.

9.1.1.6* Trapeze Hangers.

9.1.1.6.1 For trapeze hangers, the minimum size of steel angle or pipe span between purlins or joists shall be such that the available section modulus of the trapeze member from Table

the support of system piping provided such holes are permitted by applicable building codes and the spacing and support provisions for hangers of this standard are satisfied.

9.1.1.6* Trapeze Hangers.

9.1.1.6.1 For trapeze hangers, the minimum size of steel angle or pipe span between purlins or joists shall be such that the available section modulus of the trapeze member from Table 9.1.1.6.1(b) equals or exceeds the section modulus required in Table 9.1.1.6.1(a).

Table 9.1.1.6.1(a) Section Modulus Required for Trapeze Member

Span of Trapeze	Nominal Diameter of Pipe Being Supported								
	1 in. 25 mm	1¼ in. 32 mm	1½ in. 40 mm	2 in. 50 mm	2½ in. 65 mm	3 in. 80 mm	3½ in. 90 mm	4 in. 100 mm	5 in. 125 mm
1 ft 6 in. (0.46)	0.08	0.09	0.09	0.09	0.10	0.11	0.12	0.13	0.14
	0.08	0.09	0.09	0.10	0.11	0.12	0.13	0.15	0.16
2 ft 0 in. (0.61)	0.11	0.12	0.12	0.13	0.13	0.15	0.16	0.17	0.18
	0.11	0.12	0.12	0.13	0.15	0.16	0.18	0.20	0.21
2 ft 6 in. (0.76)	0.14	0.14	0.15	0.16	0.17	0.18	0.20	0.21	0.22
	0.14	0.15	0.15	0.16	0.18	0.21	0.22	0.25	0.26
3 ft 0 in. (0.91)	0.17	0.17	0.18	0.19	0.20	0.22	0.24	0.26	0.27
	0.17	0.18	0.18	0.20	0.22	0.25	0.27	0.30	0.31
4 ft 0 in. (1.2)	0.22	0.23	0.24	0.25	0.27	0.29	0.32	0.34	0.35
	0.22	0.24	0.24	0.26	0.29	0.33	0.36	0.40	0.41
5 ft 0 in. (1.5)	0.28	0.29	0.30	0.31	0.34	0.37	0.40	0.43	0.44
	0.28	0.29	0.30	0.33	0.37	0.41	0.45	0.49	0.50
6 ft 0 in. (1.8)	0.33	0.35	0.36	0.38	0.41	0.44	0.48	0.51	0.52
	0.34	0.35	0.36	0.39	0.44	0.49	0.54	0.59	0.60
7 ft 0 in. (2.1)	0.39	0.40	0.41	0.44	0.47	0.52	0.55	0.60	0.61
	0.39	0.41	0.43	0.46	0.51	0.58	0.63	0.69	0.70
8 ft 0 in. (2.4)	0.44	0.46	0.47	0.50	0.54	0.59	0.63	0.68	0.69
	0.45	0.47	0.49	0.52	0.59	0.66	0.72	0.79	0.80
9 ft 0 in. (2.7)	0.50	0.52	0.53	0.56	0.61	0.66	0.71	0.77	0.78
	0.50	0.53	0.55	0.59	0.66	0.74	0.81	0.89	0.90
10 ft 0 in. (3.0)	0.56	0.58	0.59	0.63	0.68	0.74	0.79	0.85	0.86
	0.56	0.59	0.61	0.65	0.74	0.82	0.90	0.99	1.00

For SI units, 1 in. = 25.4 mm; 1 ft = 0.3048 m.

Notes:

(1) Top values are for Schedule 10 pipe; bottom values are for Schedule 40 pipe.

(2) The table is based on a maximum allowable bending stress of 15 ksi and a midspan concentrated load from plus 250 lb (114 kg).

**Table 9.1.1.6.1(b) Available Section Moduli of
Common Trapeze Hangers (in.³)**

Pipe (in.)	Modulus	Angles	Modulus
Schedule 10			
1 (25 mm)	0.12	$1\frac{1}{2} \times 1\frac{1}{2} \times \frac{3}{16}$	0.10
1¼ (32 mm)	0.19	$2 \times 2 \times \frac{1}{8}$	0.13
1½ (40 mm)	0.26	$2 \times 1\frac{1}{2} \times \frac{3}{16}$	0.18
2 (50 mm)	0.42	$2 \times 2 \times \frac{3}{16}$	0.19
2½ (65 mm)	0.69	$2 \times 2 \times \frac{1}{4}$	0.25
3 (80 mm)	1.04	$2\frac{1}{2} \times 1\frac{1}{2} \times \frac{3}{16}$	0.28
3½ (90 mm)	1.38	$2\frac{1}{2} \times 2 \times \frac{3}{16}$	0.29
4 (100 mm)	1.76	$2 \times 2 \times \frac{5}{16}$	0.30
5 (125 mm)	3.03	$2\frac{1}{2} \times 2\frac{1}{2} \times \frac{3}{16}$	0.30
6 (150 mm)	4.35	$2 \times 2 \times \frac{3}{8}$	0.35
		$2\frac{1}{2} \times 2\frac{1}{2} \times \frac{1}{4}$	0.39
		$3 \times 2 \times \frac{3}{16}$	0.41
Schedule 40			
1 (25 mm)	0.13	$3 \times 2\frac{1}{2} \times \frac{3}{16}$	0.43
1¼ (32 mm)	0.23	$3 \times 3 \times \frac{3}{16}$	0.44
1½ (40 mm)	0.33	$2\frac{1}{2} \times 2\frac{1}{2} \times \frac{5}{16}$	0.48
2 (50 mm)	0.56	$3 \times 2 \times \frac{1}{4}$	0.54
2½ (65 mm)	1.06	$2\frac{1}{2} \times 2 \times \frac{3}{8}$	0.55
3 (80 mm)	1.72	$2\frac{1}{2} \times 2\frac{1}{2} \times \frac{3}{8}$	0.57
3½ (90 mm)	2.39	$3 \times 3 \times \frac{1}{4}$	0.58
4 (100 mm)	3.21	$3 \times 3 \times \frac{5}{16}$	0.71
5 (125 mm)	5.45	$2\frac{1}{2} \times 2\frac{1}{2} \times \frac{1}{2}$	0.72
6 (150 mm)	8.50	$3\frac{1}{2} \times 2\frac{1}{2} \times \frac{1}{4}$	0.75
		$3 \times 2\frac{1}{2} \times \frac{3}{8}$	0.81
		$3 \times 3 \times \frac{3}{8}$	0.83
		$3\frac{1}{2} \times 2\frac{1}{2} \times \frac{5}{16}$	0.93
		$3 \times 3 \times \frac{7}{16}$	0.95
		$4 \times 4 \times \frac{1}{4}$	1.05
		$3 \times 3 \times \frac{1}{2}$	1.07
$4 \times 3 \times \frac{5}{16}$	1.23		
$4 \times 4 \times \frac{5}{16}$	1.29		
$4 \times 3 \times \frac{3}{8}$	1.46		

Table 9.1.1.6.1(b) Available Section Moduli of Common Trapeze Hangers (in.³)

Pipe (in.)	Modulus s	Angles	Modulus
		4 × 4 × 3/8	1.52
		5 × 3 1/2 × 5/16	1.94
		4 × 4 × 1/2	1.97
		4 × 4 × 5/8	2.40
		4 × 4 × 3/4	2.81
		6 × 4 × 3/8	3.32
		6 × 4 × 1/2	4.33
		6 × 4 × 3/4	6.25
		6 × 6 × 1	8.57

For SI units, 1 in. = 25.4 mm; 1 ft = 0.3048 m.

9.1.1.6.2 Any other sizes or shapes giving equal or greater section modulus shall be acceptable.

9.1.1.6.3 All angles shall be installed with the longer leg vertical.

9.1.1.6.4 The trapeze member shall be secured to prevent slippage.

9.1.1.6.5* All components of each hanger assembly that attach to a trapeze member shall conform to 9.1.1.4 and be sized to support the suspended sprinkler pipe.

9.1.1.6.6 The ring, strap, or clevis installed on a pipe trapeze shall be manufactured to fit the pipe size of the trapeze member.

9.1.1.6.7 Holes for bolts shall not exceed 1/16 in. (1.6 mm) greater than the diameter of the bolt.

9.1.1.6.8 Bolts shall be provided with a flat washer and nut.

9.1.1.7* Support of Non-System Components. Sprinkler piping or hangers shall not be used to support non-system components.

9.1.2 Hanger Rods.

9.1.2.1 Unless the requirements of 9.1.2.2 are met, hanger rod size shall be the same as that approved for use with the hanger assembly, and the size of rods shall not be less than that given in Table 9.1.2.1.

Table 9.1.2.1 Hanger Rod Sizes

Pipe Size		Diameter of Rod	
in.	mm	in.	mm

Table 9.1.2.1 Hanger Rod Sizes

Pipe Size		Diameter of Rod	
in.	mm	in.	mm
Up to and including 4 in.	100 mm	$\frac{3}{8}$	9.5
5 in., 6 in., and 8 in.	125 mm, 150 mm, 200 mm	$\frac{1}{2}$	12.7
10 in. and 12 in.	250 mm, 300 mm	$\frac{5}{8}$	15.9

9.1.2.2 Rods of smaller diameters than indicated in Table 9.1.2.1 shall be permitted where the hanger assembly has been tested and listed by a testing laboratory and installed within the limits of pipe sizes expressed in individual listings.

9.1.2.3* Hanger rods shall be installed so that lateral gravity loads are not induced on the rods.

9.1.2.4 U-Hooks. The size of the rod material of U-hooks shall not be less than that given in Table 9.1.2.4.

Table 9.1.2.4 U-Hook Rod Sizes

Pipe Size		Hook Material Diameter	
in.	mm	in.	mm
Up to and including 2 in.	50 mm	$\frac{5}{16}$	7.9
2½ in. to 6 in.	65 mm to 150 mm	$\frac{3}{8}$	9.5
8 in.	200 mm	$\frac{1}{2}$	12.7

9.1.2.5 Eye Rods.

9.1.2.5.1 The size of the rod material for eye rods shall not be less than specified in Table 9.1.2.5.1.

Table 9.1.2.5.1 Eye Rod Sizes

Pipe Size		Diameter of Rod			
		With Bent Eye		With Welded Eye	
in.	mm	in.	mm	in.	mm
Up to and including 4 in.	100 mm	$\frac{3}{8}$	9.5	$\frac{3}{8}$	9.5
5 in., 6 in.	125 mm, 150 mm	$\frac{1}{2}$	12.7	$\frac{1}{2}$	12.7

Table 9.1.2.5.1 Eye Rod Sizes

Pipe Size		Diameter of Rod			
		With Bent Eye		With Welded Eye	
in.	mm	in.	mm	in.	mm
8 in.	200 mm	$\frac{3}{4}$	19.1	$\frac{1}{2}$	12.7

9.1.2.5.2 Eye rods shall be secured with lock washers to prevent lateral motion.

9.1.2.5.3 Where eye rods are fastened to wood structural members, the eye rod shall be backed with a large flat washer bearing directly against the structural member, in addition to the lock washer.

9.1.2.6 Threaded Sections of Rods. Threaded sections of rods shall not be formed or bent.

9.1.3 Fasteners in Concrete.

9.1.3.1 Unless prohibited by 9.1.3.2 or 9.1.3.3, the use of listed inserts set in concrete and listed post-installed anchors to support hangers shall be permitted for mains and branch lines.

9.1.3.2 Post-installed anchors shall not be used in cinder concrete, except for branch lines where the post-installed anchors are alternated with through-bolts or hangers attached to beams.

9.1.3.3 Post-installed anchors shall not be used in ceilings of gypsum or other similar soft material.

9.1.3.4 Unless the requirements of 9.1.3.5 are met, post-installed anchors shall be installed in a horizontal position in the sides of concrete beams.

9.1.3.5 Post-installed anchors shall be permitted to be installed in the vertical position under the following conditions:

- (1) When used in concrete having gravel or crushed stone aggregate to support pipes 4 in. (100 mm) or less in diameter
- (2) When post-installed anchors are alternated with hangers connected directly to the structural members, such as trusses and girders, or to the sides of concrete beams [to support pipe 5 in. (125 mm) or larger]
- (3) When post-installed anchors are spaced not over 10 ft (3 m) apart [to support pipe 4 in. (100 mm) or larger]

9.1.3.6 Holes for post-installed anchors in the side of beams shall be above the centerline of the beam or above the bottom reinforcement steel rods.

9.1.3.7 Holes for post-installed anchors used in the vertical position shall be drilled to provide uniform contact with the shield over its entire circumference.

9.1.3.8 The depth of the post-installed anchor hole shall not be less than specified for the type of shield used.

9.1.3.9 Powder-Driven Studs.

9.1.3.9.1 Powder-driven studs, welding studs, and the tools used for installing these devices shall be listed.

9.1.3.9.2 Pipe size, installation position, and construction material into which they are installed shall be in accordance with individual listings.

9.1.3.9.3* Representative samples of concrete into which studs are to be driven shall be tested to determine that the studs will hold a minimum load of 750 lb (341 kg) for 2 in. (50 mm) or smaller pipe; 1000 lb (454 kg) for 2½ in., 3 in., or 3½ in. (65 mm, 80 mm, or 90 mm) pipe; and 1200 lb (545 kg) for 4 in. or 5 in. (100 mm or 125 mm) pipe.

9.1.3.9.4 Increaser couplings shall be attached directly to the powder-driven studs.

9.1.3.10 Minimum Bolt Size for Concrete.

9.1.3.10.1 The size of a bolt used with a hanger and installed through concrete shall not be less than specified in Table 9.1.3.10.1.

Table 9.1.3.10.1 Minimum Bolt Size for Concrete

Pipe Size		Size of Bolt	
in.	mm	in.	mm
Up to and including 4 in.	100 mm	$\frac{3}{8}$	10
5 in.	125 mm	$\frac{1}{2}$	13
6 in.	150 mm		
8 in.	200 mm		
10 in.	250 mm	$\frac{5}{8}$	15
12 in.	300 mm	$\frac{3}{4}$	20

9.1.3.10.2 Holes for bolts shall not exceed $\frac{1}{16}$ in. (1.6 mm) greater than the diameter of the bolt.

9.1.3.10.3 Bolts shall be provided with a flat washer and nut.

9.1.4 Fasteners in Steel.

9.1.4.1* Powder-driven studs, welding studs, and the tools used for installing these devices shall be listed.

9.1.4.2 Pipe size, installation position, and construction material into which they are installed shall be in accordance with individual listings.

9.1.4.3 Increaser couplings shall be attached directly to the powder-driven studs or welding studs.

9.1.4.4 Welding studs or other hanger parts shall not be attached by welding to steel less than U.S. Standard, 12 gauge (2.78 mm).

9.1.4.5 Minimum Bolt Size for Steel.

9.1.4.5.1 The size of a bolt used with a hanger and installed through steel shall not be less than specified in Table 9.1.4.5.1.

Table 9.1.4.5.1 Minimum Bolt Size for Steel

Pipe Size		Size of Bolt	
in.	mm	in.	mm
Up to and including 4 in.	100 mm	$\frac{3}{8}$	10
5 in.	125 mm	$\frac{1}{2}$	12
6 in.	150 mm		
8 in.	200 mm		
10 in.	250 mm	$\frac{5}{8}$	15
12 in.	300 mm	$\frac{3}{4}$	20

9.1.4.5.2 Holes for bolts shall not exceed $\frac{1}{16}$ in. (1.6 mm) greater than the diameter of the bolt.

9.1.4.5.3 Bolts shall be provided with a flat washer and nut.

9.1.5 Fasteners in Wood.

9.1.5.1 Drive Screws.

9.1.5.1.1 Drive screws shall be used only in a horizontal position as in the side of a beam and only for 2 in. (50 mm) or smaller pipe.

9.1.5.1.2 Drive screws shall only be used in conjunction with hangers that require two points of attachments.

9.1.5.2 Ceiling Flanges and U-Hooks with Screws.

9.1.5.2.1 Unless the requirements of 9.1.5.2.2 or 9.1.5.2.3 are met, for ceiling flanges and U-hooks, screw dimensions shall not be less than those given in Table 9.1.5.2.1.

Table 9.1.5.2.1 Screw Dimensions for Ceiling Flanges and U-Hooks

Pipe Size		Two Screw Ceiling Flanges
Up to and including 2 in.	50 mm	Wood screw No. 18 × 1½ in. or Lag screw $\frac{5}{16}$ in. × 1½ in.
Pipe Size		Three Screw Ceiling Flanges

**Table 9.1.5.2.1 Screw Dimensions for Ceiling
Flanges and U-Hooks**

Pipe Size		Two Screw Ceiling Flanges
Up to and including 2 in.	50 mm	Wood screw No.18 × 1½ in.
2½ in., 3 in., 3½ in.	65 mm 80 mm 90 mm	Lag screw ¾ in. × 2 in.
4 in., 5 in., 6 in.	100 mm 125 mm 150 mm	Lag screw ½ in. × 2 in.
8 in.	200 mm	Lag screw ⅝ in. × 2 in.
Pipe Size		Four Screw Ceiling Flanges
Up to and including 2 in.	50 mm	Wood screw No. 18 × 1½ in.
2½ in., 3 in., 3½ in.	65 mm 80 mm 90 mm	Lag screw ¾ in. × 1½ in.
4 in., 5 in., 6 in.	100 mm 125 mm 150 mm	Lag screw ½ in. × 2 in.
8 in.	200 mm	Lag screw ⅝ in. × 2 in.
Pipe Size		U-Hooks
Up to and including 2 in.	50 mm	Drive screw No. 16 × 2 in.
2½ in., 3 in., 3½ in.	65 mm 80 mm 90 mm	Lag screw ¾ in. × 2½ in.
4 in., 5 in., 6 in.	100 mm 125 mm 150 mm	Lag screw ½ in. × 3 in.
8 in.	200 mm	Lag screw ⅝ in. × 3 in.

9.1.5.2.2 When the thickness of planking and thickness of flange do not permit the use of screws 2 in. (50 mm) long, screws 1¾ in. (45 mm) long shall be permitted with hangers spaced not over 10 ft (3 m) apart.

9.1.5.2.3 When the thickness of beams or joists does not permit the use of screws 2½ in. (60 mm) long, screws 2 in. (50 mm) long shall be permitted with hangers spaced not over 10 ft (3 m) apart.

9.1.5.3 Bolt or Lag Screw.

9.1.5.3.1 Unless the requirements of 9.1.5.3.2 are met, the size of bolt or lag screw used with a hanger and installed on the side of the beam shall not be less than specified in Table 9.1.5.3.1.

**Table 9.1.5.3.1 Minimum Bolt or Lag Screw Sizes for Side of Beam
Installation**

9.1.5.3.1 Unless the requirements of 9.1.5.3.2 are met, the size of bolt or lag screw used with a hanger and installed on the side of the beam shall not be less than specified in Table 9.1.5.3.1.

Table 9.1.5.3.1 Minimum Bolt or Lag Screw Sizes for Side of Beam Installation

Pipe Size		Size of Bolt or Lag Screw		Length of Lag Screw Used with Wood Beams	
in.	mm	in.	mm	in.	mm
Up to and including 2 in.	50 mm	$\frac{3}{8}$	10	2½	64
2½ in. to 6 in. (inclusive)	65 mm–150 mm	½	12	3	76
8 in.	200 mm	$\frac{5}{8}$	15	3	76

9.1.5.3.2 Where the thickness of beams or joists does not permit the use of screws 2½ in. (60 mm) long, screws 2 in. (50 mm) long shall be permitted with hangers spaced not over 10 ft (3 m) apart.

9.1.5.3.3 All holes for lag screws shall be pre-drilled $\frac{1}{8}$ in. (3.2 mm) less in diameter than the maximum root diameter of the lag screw thread.

9.1.5.3.4 Holes for bolts shall not exceed $\frac{1}{16}$ in. (1.6 mm) greater than the diameter of the bolt.

9.1.5.3.5 Bolts shall be provided with a flat washer and nut.

9.1.5.4 Wood Screws. Wood screws shall be installed with a screwdriver.

9.1.5.5 Nails. Nails shall not be acceptable for fastening hangers.

9.1.5.6 Screws in Side of Timber or Joists.

9.1.5.6.1 Screws in the side of a timber or joist shall be not less than 2½ in. (64 mm) from the lower edge where supporting branch lines and not less than 3 in. (76 mm) where supporting main lines.

9.1.5.6.2 The requirements of 9.1.5.6.1 shall not apply to 2 in. (51 mm) or thicker nailing strips resting on top of steel beams.

9.1.5.7 Coach Screw Rods.

9.1.5.7.1 Minimum Coach Screw Rod Size. The size of coach screw rods shall not be less than the requirements of Table 9.1.5.7.1.

Table 9.1.5.7.1 Minimum Coach Screw Rod Size

Pipe Size		Diameter of Rod		Minimum Penetration	
in.	mm	in.	mm	in.	mm

Table 9.1.5.7.1 Minimum Coach Screw Rod Size

Pipe Size		Diameter of Rod		Minimum Penetration	
in.	mm	in.	mm	in.	mm
Up to and including 4 in.	100 mm	3/8	10	3	76
Larger than 4 in.	100 mm	Not permitted	Not permitted	Not permitted	Not permitted

9.1.5.7.2 The minimum plank thickness and the minimum width of the lower face of beams or joists in which coach screw rods are used shall be not less than that specified in Table 9.1.5.7.2.

Table 9.1.5.7.2 Minimum Plank Thicknesses and Beam or Joist Widths

Pipe Size		Nominal Plank Thickness		Nominal Width of Beam or Joist Face	
in.	mm	in.	mm	in.	mm
Up to and including 2 in.	50 mm	3	76	2	51
2½ in.	65 mm	4	102	2	51
3 in.	80 mm				
3½ in.	90 mm				
4 in.	100 mm	4	102	3	76

9.1.5.7.3 Coach screw rods shall not be used for support of pipes larger than 4 in. (100 mm) in diameter.

9.1.5.7.4 All holes for coach screw rods shall be predrilled 1/8 in. (3.2 mm) less in diameter than the maximum root diameter of the wood screw thread.

9.2* Installation of Pipe Hangers.

9.2.1 General.

9.2.1.1 Ceiling Sheathing.

9.2.1.1.1 Unless the requirements of 9.2.1.1.2 are met, sprinkler piping shall be supported independently of the ceiling sheathing.

9.2.1.1.2 Toggle hangers shall be permitted only for the support of pipe 1½ in. (40 mm) or smaller in size under ceilings of hollow tile or metal lath and plaster.

9.2.1.2 Storage Racks. Where sprinkler piping is installed in storage racks, piping shall be supported from the storage rack structure or building in accordance with all applicable provisions of Sections 9.2 and 9.3.

9.2.1.3* Building Structure.

9.2.1.3.1 Unless the requirements of 9.2.1.3.3 apply, sprinkler piping shall be substantially supported from the building structure, which must support the added load of the water-filled pipe plus a minimum of 250 lb (114 kg) applied at the point of hanging, except where permitted by 9.2.1.1.2, 9.2.1.3.3, and 9.2.1.4.1.

9.2.1.3.2 Trapeze hangers shall be used where necessary to transfer loads to appropriate structural members.

9.2.1.3.3* Flexible Sprinkler Hose Fittings.

9.2.1.3.3.1 Listed flexible sprinkler hose fittings and their anchoring components intended for use in installations connecting the sprinkler system piping to sprinklers shall be installed in accordance with the requirements of the listing, including any installation instructions.

9.2.1.3.3.2 When installed and supported by suspended ceilings, the ceiling shall meet ASTM C 635, *Standard Specification for the Manufacture, Performance, and Testing of Metal Suspension Systems for Acoustical Tile and Lay-In Panel Ceilings*, and shall be installed in accordance with ASTM C 636, *Standard Practice for Installation of Metal Ceiling Suspension Systems for Acoustical Tile and Lay-In Panels*.

9.2.1.3.3.3* Where flexible sprinkler hose fittings exceed 6 ft (1.83 m) in length and are supported by a suspended ceiling, a hanger(s) attached to the structure shall be required to ensure that the maximum unsupported length does not exceed 6 ft (1.83 m).

9.2.1.4 Metal Deck.

9.2.1.4.1* Branch line hangers attached to metal deck shall be permitted only for the support of pipe 1 in. (25 mm) or smaller in size, by drilling or punching the vertical portion of the metal deck and using through bolts.

9.2.1.4.2 The distance from the bottom of the bolt hole to the bottom of the vertical member shall be not less than $\frac{3}{8}$ in. (9.5 mm).

9.2.1.5 Where sprinkler piping is installed below ductwork, piping shall be supported from the building structure or from the ductwork supports, provided such supports are capable of handling both the load of the ductwork and the load specified in 9.2.1.3.1.

9.2.2* Maximum Distance Between Hangers.

9.2.2.1 The maximum distance between hangers shall not exceed that specified in Table 9.2.2.1(a) or Table 9.2.2.1(b), except where the provisions of 9.2.4 apply.

Table 9.2.2.1(a) Maximum Distance Between Hangers (ft-in)

	Nominal Pipe Size (in.)							
	$\frac{3}{4}$	1	1 $\frac{1}{4}$	1 $\frac{1}{2}$	2	2 $\frac{1}{2}$	3	3 $\frac{1}{2}$
Steel pipe except threaded lightwall	N/A	12-0	12-0	15-0	15-0	15-0	15-0	15-0
Threaded lightwall steel pipe	N/A	12-0	12-0	12-0	12-0	12-0	12-0	N/A
Copper tube	8-0	8-0	10-0	10-0	12-0	12-0	12-0	15-C
CPVC	5-6	6-0	6-6	7-0	8-0	9-0	10-0	N/A
Polybutylene (IPS)	N/A	3-9	4-7	5-0	5-11	N/A	N/A	N/A

Table 9.2.2.1(a) Maximum Distance Between Hangers (ft-in)

	Nominal Pipe Size (in.)							
	¾	1	1¼	1½	2	2½	3	3½
Polybutylene (CTS)	2-11	3-4	3-11	4-5	5-5	N/A	N/A	N/A
Ductile iron pipe	N/A	N/A	N/A	N/A	N/A	N/A	15-0	N/A

Note: IPS iron — pipe size; CTS — copper tube size.

Table 9.2.2.1(b) Maximum Distance Between Hangers (metric)

	Nominal Pipe Size (m)							
	20	25	32	40	50	65	80	90
Steel pipe except threaded lightwall	N/A	3.66	3.66	4.57	4.57	4.57	4.57	4.57
Threaded lightwall steel pipe	N/A	3.66	3.66	3.66	3.66	3.66	3.66	N/A
Copper tube	2.44	2.44	3.05	3.05	3.66	3.66	3.66	4.57
CPVC	1.68	1.83	1.98	2.13	2.44	2.74	3.05	N/A
Polybutylene (IPS)	N/A	1.14	1.4	1.52	1.8	N/A	N/A	N/A
Polybutylene (CTS)	0.89	1.02	1.19	1.35	1.65	N/A	N/A	N/A
Ductile iron pipe	N/A	N/A	N/A	N/A	N/A	N/A	4.57	N/A

Note: IPS iron — pipe size; CTS — copper tube size.

9.2.2.2 The maximum distance between hangers for listed nonmetallic pipe shall be modified as specified in the individual product listings.

9.2.3 Location of Hangers on Branch Lines.

9.2.3.1 Subsection 9.2.3 shall apply to the support of steel pipe or copper tube as specified in 6.3.1 and subject to the provisions of 9.2.2.

9.2.3.2* Minimum Number of Hangers.

9.2.3.2.1 Unless the requirements of 9.2.3.2.2 or 9.2.3.2.3 are met, there shall be not less than one hanger for each section of pipe.

9.2.3.2.2* Where sprinklers are spaced less than 6 ft (1.8 m) apart, hangers spaced up to a maximum of 12 ft (3.7 m) shall be permitted.

9.2.3.2.3* Starter lengths less than 6 ft (1.8 m) shall not require a hanger, unless on the end line of a sidefeed system or where an intermediate cross main hanger has been omitted.

9.2.3.3 Clearance to Hangers. The distance between a hanger and the centerline of an upright sprinkler shall not be less than 3 in. (76 mm).

9.2.3.4* Unsupported Lengths.

9.2.3.4.1 The unsupported length between the end sprinkler and the last hanger on the line shall not be greater than 36 in. (0.9 m) for 1 in. (25 mm) pipe, 48 in. (1.2 m) for 1¼ in. (32 mm) pipe, and 60 in. (1.5 m) for 1½ in. (40 mm) or larger pipe.

9.2.3.4.2 For copper tube, the unsupported length between the end sprinkler and the last hanger on the line shall not be greater than 18 in. (457 mm) for 1 in. (25 mm) pipe, 24 in. (610 mm) for 1¼ in. (32 mm) pipe, and 30 in. (762 mm) for 1½ in. (40 mm) or larger pipe.

9.2.3.4.3 Where the limits of 9.2.3.4.1 and 9.2.3.4.2 are exceeded, the pipe shall be extended beyond the end sprinkler and shall be supported by an additional hanger.

9.2.3.4.4* Unsupported Length with Maximum Pressure Exceeding 100 psi (6.9 bar) and a Branch Line Above a Ceiling Supplying Sprinklers in a Pendent Position Below the Ceiling.

9.2.3.4.4.1 When the maximum static or flowing pressure, whichever is greater at the sprinkler, applied other than through the fire department connection, exceeds 100 psi (6.9 bar) and a branch line above a ceiling supplies sprinklers in a pendent position below the ceiling, the hanger assembly supporting the pipe supplying an end sprinkler in a pendent position shall be of a type that prevents upward movement of the pipe.

9.2.3.4.4.2 The unsupported length between the end sprinkler in a pendent position or drop nipple and the last hanger on the branch line shall not be greater than 12 in. (305 mm) for steel pipe or 6 in. (152 mm) for copper pipe.

9.2.3.4.4.3 When the limit of 9.2.3.4.4.2 is exceeded, the pipe shall be extended beyond the end sprinkler and supported by an additional hanger.

9.2.3.4.4.4 The hanger closest to the sprinkler shall be of a type that prevents upward movement of the piping.

9.2.3.5* Unsupported Armovert Length.

9.2.3.5.1 The cumulative horizontal length of an unsupported armovert to a sprinkler, sprinkler drop, or sprig shall not exceed 24 in. (610 mm) for steel pipe or 12 in. (305 mm) for copper tube.

9.2.3.5.2* Unsupported Armovert Length with Maximum Pressures Exceeding 100 psi (6.9 bar) and a Branch Line Above a Ceiling Supplying Sprinklers in a Pendent Position Below the Ceiling.

9.2.3.5.2.1 Where the maximum static or flowing pressure, whichever is greater at the sprinkler, applied other than through the fire department connection, exceeds 100 psi (6.9 bar) and a branch line above a ceiling supplies sprinklers in a pendent position below the ceiling, the cumulative horizontal length of an unsupported armovert to a sprinkler or sprinkler drop shall not exceed 12 in. (305 mm) for steel pipe and 6 in. (152 mm) for copper tube.

9.2.3.5.2.2 The hanger closest to the sprinkler shall be of a type that prevents upward movement of the piping.

9.2.3.6 Wall-mounted sidewall sprinklers shall be restrained to prevent movement.

9.2.3.7 Sprigs. Sprigs 4 ft (1.2 m) or longer shall be restrained against lateral movement.

9.2.4 Location of Hangers on Mains.

9.2.4.1 Unless the requirements of 9.2.4.2, 9.2.4.3, 9.2.4.4, or 9.2.4.5 are met, hangers for mains shall be in accordance with 9.2.2, between each branch line, or on each section of pipe, whichever is the lesser dimension.

9.2.4.2 For cross mains in steel pipe systems in bays having two branch lines, the intermediate hanger shall be permitted to be omitted, provided that a hanger attached to a purlin is installed on each branch line located as near to the cross main as the location of the purlin permits. The remaining branch line hangers shall be installed in accordance with 9.2.3.

9.2.4.3 For cross mains in steel pipe systems only in bays having three branch lines, either side or center feed, one (only) intermediate hanger shall be permitted to be omitted, provided that a hanger attached to a purlin is installed on each branch line located as near to the cross main as the location of the purlin permits. The remaining branch line hangers shall be installed in accordance with 9.2.3.

9.2.4.4 For cross mains in steel pipe systems only in bays having four or more branch lines, either side or center feed, two intermediate hangers shall be permitted to be omitted, provided the maximum distance between hangers does not exceed the distances specified in 9.2.2 and a hanger attached to a purlin on each branch line is located as near to the cross main as the purlin permits.

9.2.4.5 At the end of the main, intermediate trapeze hangers shall be installed unless the main is extended to the next framing member with a hanger installed at this point, in which event an intermediate hanger shall be permitted to be omitted in accordance with 9.2.4.2, 9.2.4.3, and 9.2.4.4.

9.2.5 Support of Risers.

9.2.5.1 Risers shall be supported by riser clamps or by hangers located on the horizontal connections within 24 in. (610 mm) of the centerline of the riser.

9.2.5.2 Riser clamps supporting risers by means of set screws shall not be used.

9.2.5.3* Riser clamps anchored to walls using hanger rods in the horizontal position shall not be permitted to vertically support risers.

9.2.5.4 Multistory Buildings.

9.2.5.4.1 In multistory buildings, riser supports shall be provided at the lowest level, at each alternate level above, above and below offsets, and at the top of the riser.

9.2.5.4.2* Supports above the lowest level shall also restrain the pipe to prevent movement by an upward thrust where flexible fittings are used.

9.2.5.4.3 Where risers are supported from the ground, the ground support shall constitute the first level of riser support.

9.2.5.4.4 Where risers are offset or do not rise from the ground, the first ceiling level above the offset shall constitute the first level of riser support.

9.2.5.5 Distance between supports for risers shall not exceed 25 ft (7.6 m).

9.2.6* Pipe Stands.

9.2.6.1 Pipe stands shall be sized to support a minimum of 5 times the weight of the water-filled pipe, plus 250 lb (114 kg).

9.2.6.2 Where pipe stands are utilized, they shall be approved.

9.3 Protection of Piping Against Damage Where Subject to Earthquakes.

9.3.1* General.

9.3.1.1 Where water-based fire protection systems are required to be protected against damage from earthquakes, the requirements of Section 9.3 shall apply, unless the requirements of 9.3.1.2 are met.

9.3.1.2 Alternative methods of providing earthquake protection of sprinkler systems based on a seismic analysis certified by a registered professional engineer such that system performance will be at least equal to that of the building structure under expected seismic forces shall be permitted.

9.3.1.3 Displacement due to story drift is addressed in 9.3.2 through 9.3.4.

9.3.1.4 Obstructions to Sprinklers. Braces and restraints shall not obstruct sprinklers and shall comply with the obstruction rules of Chapter 8.

9.3.2* Couplings.

9.3.2.1 Listed flexible pipe couplings joining grooved end pipe shall be provided as flexure joints to allow individual sections of piping 2½ in. (65 mm) or larger to move differentially with the individual sections of the building to which it is attached.

9.3.2.2 Couplings shall be arranged to coincide with structural separations within a building.

9.3.2.3 Systems having more flexible couplings than required by this section shall be provided with additional sway bracing as required in 9.3.5.3.7. The flexible couplings shall be installed as follows:

- (1) Within 24 in. (610 mm) of the top and bottom of all risers, unless the following provisions are met:
 - (a) In risers less than 3 ft (0.9 m) in length, flexible couplings are permitted to be omitted.
 - (b) In risers 3 ft to 7 ft (0.9 m to 2.1 m) in length, one flexible coupling is adequate.
- (2) Within 12 in. (305 mm) above and within 24 in. (610 mm) below the floor in multistory buildings. When the flexible coupling below the floor is above the tie-in main to the main supplying that floor, a flexible coupling shall be provided in accordance with one of the following:
 - (a)* On the horizontal portion within 24 in. (610 mm) of the tie-in where the tie-in is horizontal
 - (b)* On the vertical portion of the tie-in where the tie-in incorporates a riser

- (3) On both sides of concrete or masonry walls within 1 ft (305 mm) of the wall surface, unless clearance is provided in accordance with 9.3.4
- (4)* Within 24 in. (610 mm) of building expansion joints
- (5) Within 24 in. (610 mm) of the top of drops exceeding 15 ft (4.6 m) in length to portions of systems supplying more than one sprinkler, regardless of pipe size
- (6) Above and below any intermediate points of support for a riser or other vertical pipe

9.3.2.4* Flexible Couplings for Drops. Flexible couplings for drops to hose lines, rack sprinklers, and mezzanines shall be installed regardless of pipe sizes as follows:

- (1) Within 24 in. (610 mm) of the top of the drop
- (2) Within 24 in. (610 mm) above the uppermost drop support attachment, where drop supports are provided to the structure, rack, or mezzanine
- (3) Within 24 in. (610 mm) above the bottom of the drop where no additional drop support is provided

9.3.3* Seismic Separation Assembly.

9.3.3.1 An approved seismic separation assembly shall be installed where sprinkler piping, regardless of size, crosses building seismic separation joints above ground level.

9.3.3.2 Seismic separation assemblies shall consist of flexible fittings or flexible piping so as to allow movement sufficient to accommodate closing of the separation, opening of the separation to twice its normal size, and movement relative to the separation in the other two dimensions in an amount equal to the separation distance.

9.3.3.3* The seismic separation assembly shall include a four-way brace upstream and downstream within 6 ft (1.83 m) of the seismic separation assembly.

9.3.3.4 Bracing shall not be attached to the seismic separation assembly.

9.3.4* Clearance.

9.3.4.1 Clearance shall be provided around all piping extending through walls, floors, platforms, and foundations, including drains, fire department connections, and other auxiliary piping.

9.3.4.2 Unless the requirements of 9.3.4.3, 9.3.4.4, or 9.3.4.5 are met, where pipe passes through holes in platforms, foundations, walls, or floors, the holes shall be sized such that the diameter of the holes is nominally 2 in. (50 mm) larger than the pipe for pipe 1 in. (25 mm) nominal to 3½ in. (90 mm) nominal and 4 in. (100 mm) larger than the pipe for pipe 4 in. (100 mm) nominal and larger.

9.3.4.3 Where clearance is provided by a pipe sleeve, a nominal diameter 2 in. (50 mm) larger than the nominal diameter of the pipe is acceptable for pipe sizes 1 in. (25 mm) through 3½ in. (90 mm), and the clearance provided by a pipe sleeve of nominal diameter 4 in. (100 mm) larger than the nominal diameter of the pipe is acceptable for pipe sizes 4 in. (100 mm) and larger.

9.3.4.4 No clearance is required for piping passing through gypsum board or equally frangible construction that is not required to have a fire resistance rating.

9.3.4.5 No clearance is required if flexible couplings are located within 1 ft (305 mm) of each side of a wall, floor, platform, or foundation.

9.3.4.6 No clearance is required where horizontal piping passes perpendicularly through successive studs or joists that form a wall or floor/ceiling assembly.

9.3.4.7 No clearance is required where nonmetallic pipe has been demonstrated to have inherent flexibility equal to or greater than the minimum provided by flexible couplings located within 1 ft (305 mm) of each side of a wall, floor, platform, or foundation.

9.3.4.8 Where required, the clearance shall be filled with a flexible material that is compatible with the piping material.

9.3.4.9 Clearance from structural members not penetrated or used, collectively or independently, to support the piping shall be at least 2 in. (50 mm).

9.3.5* Sway Bracing.

9.3.5.1 General.

9.3.5.1.1 The system piping shall be braced to resist both lateral and longitudinal horizontal seismic loads and to prevent vertical motion resulting from seismic loads.

9.3.5.1.2 The structural components to which bracing is attached shall be determined to be capable of resisting the added applied seismic loads.

9.3.5.1.3* Horizontal loads on system piping shall be determined in accordance with 9.3.5.6.

9.3.5.2 Sway Bracing.

9.3.5.2.1 Sway braces shall be designed to withstand forces in tension and compression, unless the requirements of 9.3.5.2.2 are met.

9.3.5.2.2* Tension-only bracing systems shall be permitted for use where listed for this service and where installed in accordance with their listing limitations, including installation instructions.

9.3.5.3 Lateral Sway Bracing.

9.3.5.3.1* Lateral sway bracing shall be provided on all feed and cross mains regardless of size and all branch lines and other piping with a diameter of 2 ½ in. (65 mm) and larger.

9.3.5.3.2* Lateral sway bracing shall be spaced in accordance with Table 9.3.5.3.2(a) or Table 9.3.5.3.2(b), and spacing shall not exceed a maximum interval of 40 ft (12.2 m) on center. The maximum permissible load in the zone of influence of a sway brace shall not exceed the values given in Table 9.3.5.3.2(a) or Table 9.3.5.3.2(b).

Table 9.3.5.3.2(a) Maximum Load F_{pw} in Zone of Influence (pounds), Schedule 10 Steel Pipe

center. The maximum permissible load in the zone of influence of a sway brace shall not exceed the values given in Table 9.3.5.3.2(a) or Table 9.3.5.3.2(b).

Table 9.3.5.3.2(a) Maximum Load F_{pw} in Zone of Influence (pounds), Schedule 10 Steel Pipe

Pipe (in.)	Lateral Sway Brace Spacing			
	20 ft	25 ft	30 ft	40 ft
1	120	96	79	56
1¼	190	152	125	89
1½	260	208	170	122
2	420	336	275	198
2½	690	552	452	325
3	1040	832	682	489
3½	1380	1104	904	649
4	1760	1408	1154	828
5	3030	2424	1986	1425
6 and larger	4350	3480	2851	2046

Table 9.3.5.3.2(b) Maximum Load F_{pw} in Zone of Influence (pounds), Schedule 40 Steel Pipe

Pipe (in.)	Lateral Sway Spacing			
	20 ft	25 ft	30 ft	40 ft
1	130	104	85	61
1¼	230	184	151	108
1½	330	264	216	155
2	560	448	367	263
2½	1060	848	695	499
3	1720	1376	1127	809
3½	2390	1912	1566	1124
4	3210	2568	2104	1510
5	5450	4360	3572	2564
6 and larger	8500	6800	5571	3999

9.3.5.3.3 The requirements of 9.3.5.3.1 shall not apply to 2½ in. (65 mm) starter pieces that do not exceed 12 ft (3.66 m) in length. The load capacity of the brace assembly shall be determined by the capacity of its weakest component.

9.3.5.3.4 The distance between the last brace and the end of the pipe shall not exceed 6 ft (1.8 m).

9.3.5.3.5 The last length of pipe at the end of a feed or cross main shall be provided with a lateral brace.

9.3.5.3.6 Lateral braces shall be allowed to act as longitudinal braces if they are within 24 in. (610 mm) of the centerline of the piping braced longitudinally for lines that are 2½ in. (65 mm) and greater in diameter.

9.3.5.3.7 Where flexible couplings are installed on mains other than as required in 9.3.2, a lateral brace shall be provided within 24 in. (610 mm) of every other coupling, including flexible couplings at grooved fittings, but not more than 40 ft (12.2 m) on center.

9.3.5.3.8 The requirements of 9.3.5.3 shall not apply to pipes individually supported by rods less than 6 in. (152 mm) long measured between the top of the pipe and the point of attachment to the building structure.

9.3.5.3.9 The requirements of 9.3.5.3 shall not apply where U-type hooks of the wraparound type or those U-type hooks arranged to keep the pipe tight to the underside of the structural element shall be permitted to be used to satisfy the requirements for lateral sway bracing, provided the legs are bent out at least 30 degrees from the vertical and the maximum length of each leg and the rod size satisfies the conditions of Table 9.3.5.8.8(a), Table 9.3.5.8.8(b), and Table 9.3.5.8.8(c).

9.3.5.4 Longitudinal Sway Bracing.

9.3.5.4.1 Longitudinal sway bracing spaced at a maximum of 80 ft (24.4 m) on center shall be provided for feed and cross mains.

9.3.5.4.2 Longitudinal braces shall be allowed to act as lateral braces if they are within 24 in. (610 mm) of the centerline of the piping braced laterally.

9.3.5.4.3 The distance between the last brace and the end of the pipe shall not exceed 40 ft (12.2 m).

9.3.5.5 Risers.

9.3.5.5.1* Tops of risers exceeding 3 ft (1 m) in length shall be provided with a four-way brace.

9.3.5.5.2 Distance between four-way braces for risers shall not exceed 25 ft (7.6 m).

9.3.5.5.3 Four-way bracing shall not be required where risers penetrate intermediate floors in multistory buildings where the clearance does not exceed the limits of 9.3.4.

9.3.5.6* Horizontal Seismic Loads.

9.3.5.6.1* The horizontal seismic load for the braces shall be as determined in 9.3.5.6.4 or 9.3.5.6.5, or as required by the authority having jurisdiction. The weight of the system being braced (W_p) shall be taken as 1.15 times the weight of the water-filled piping. (*See A.9.3.5.6.1.*)

9.3.5.6.2 The horizontal force, F_{pw} , acting on the brace shall be taken as $F_{pw} = C_p W_p$, where C_p is the seismic coefficient selected in Table 9.3.5.6.2 utilizing the short period response parameter S_s . The value of S_s used in Table 9.3.5.6.2 shall be obtained from the authority having jurisdiction or from seismic hazard maps. Linear interpolation shall be

permitted to be used for intermediate values of S_s .

Table 9.3.5.6.2 Seismic Coefficient Table

S_s	C_p
0.33 or less	0.31
0.50	0.40
0.75	0.43
0.95	0.50
1.00	0.52
1.25	0.60
1.50	0.71
2.00	0.95
2.40	1.14
3.00	1.43

9.3.5.6.3* Where the authority having jurisdiction does not specify the horizontal seismic load, the horizontal seismic force acting on the braces shall be determined as specified in 9.3.5.6.2 with $C_p = 0.5$.

9.3.5.6.4* The zone of influence for lateral braces shall include all branch lines and mains tributary to the brace, except branch lines that are provided with longitudinal bracing.

9.3.5.6.5 The zone of influence for longitudinal braces shall include all mains tributary to the brace.

9.3.5.7 Net Vertical Reaction Forces. Where the horizontal seismic loads used exceed $0.5 W_p$ and the brace angle is less than 45 degrees from vertical or where the horizontal seismic load exceeds $1.0 W_p$ and the brace angle is less than 60 degrees from vertical, the braces shall be arranged to resist the net vertical reaction produced by the horizontal load.

9.3.5.8* Horizontal Loads.

9.3.5.8.1 Sway bracing shall be tight.

9.3.5.8.2 For individual braces, the slenderness ratio (l/r) shall not exceed 300, where l is the length of the brace and r is the least radius of gyration.

9.3.5.8.3 Where threaded pipe is used as part of a sway brace assembly, it shall not be less than Schedule 30.

9.3.5.8.4 All parts and fittings of a brace shall lie in a straight line to avoid eccentric loadings on fittings and fasteners.

9.3.5.8.5 For longitudinal braces only, the brace shall be permitted to be connected to a tab welded to the pipe in conformance to 6.5.2.

9.3.5.8.6 For tension-only braces, two tension-only brace components opposing each other

must be installed at each lateral or longitudinal brace location.

9.3.5.8.7 For all braces, whether or not listed, the maximum allowable horizontal load shall be based on the weakest component of the brace with safety factors.

9.3.5.8.8* The loads determined in 9.3.5.6 shall not exceed the lesser of the maximum allowable loads provided in Table 9.3.5.8.8(a), Table 9.3.5.8.8(b), and Table 9.3.5.8.8(c) or the manufacturer's certified maximum allowable horizontal loads for brace angles of 30 to 44 degrees, 45 to 59 degrees, 60 to 89 degrees, or 90 degrees.

Table 9.3.5.8.8(a) Maximum Horizontal Loads for Sway Braces with $l/r = 100$ for S							
Brace Shape and Size	Area (in. ²)	Least Radius of Gyration r (in.)	Maximum Length for $l/r = 100$				
			ft	ft	in.	30° to Angle from Vertical	
Pipe Schedule 40	1 in.	0.494	0.421	3.5	3 ft	6 in.	4,26'
	1¼ in.	0.669	0.54	4.5	4 ft	6 in.	5,77'
	1½ in.	0.799	0.623	5.2	5 ft	2 in.	6,89'
	2 in.	1.07	0.787	6.6	6 ft	6 in.	9,23'
Angles	1½ × 1½ × ¼ in.	0.688	0.292	2.4	2 ft	5 in.	5,93'
	2 × 2 × ¼ in.	0.938	0.391	3.3	3 ft	3 in.	8,09'
	2½ × 2 × ¼ in.	1.06	0.424	3.5	3 ft	6 in.	9,14'
	2½ × 2½ × ¼ in.	1.19	0.491	4.1	4 ft	1 in.	10,27'
	3 × 2½ × ¼ in.	1.31	0.528	4.4	4 ft	4 in.	11,30'
	3 × 3 × ¼ in.	1.44	0.592	4.9	4 ft	11 in.	12,42'
Rods (all thread)	⅜ in.	0.07	0.075	0.6	0 ft	7 in.	604'
	½ in.	0.129	0.101	0.8	0 ft	10 in.	1,11'
	⅝ in.	0.207	0.128	1.1	1 ft	0 in.	1,78'
	¾ in.	0.309	0.157	1.3	1 ft	3 in.	2,66'
	⅞ in.	0.429	0.185	1.5	1 ft	6 in.	3,70'
Rods (threaded at ends only)	⅜ in.	0.11	0.094	0.8	0 ft	9 in.	949'
	½ in.	0.196	0.125	1.0	1 ft	0 in.	1,69'
	⅝ in.	0.307	0.156	1.3	1 ft	3 in.	2,64'
	¾ in.	0.442	0.188	1.6	1 ft	6 in.	3,81'
	⅞ in.	0.601	0.219	1.8	1 ft	9 in.	5,18'
Flats	1½ × ¼ in.	0.375	0.0722	0.6	0 ft	7 in.	3,23'
	2 × ¼ in.	0.5	0.0722	0.6	0 ft	7 in.	4,31'
	2 × ⅜ in.	0.75	0.1082	0.9	0 ft	10 in.	6,47'

Table 9.3.5.8.8(b) Maximum Horizontal Loads for Sway Braces with $l/r = 200$ for S							

Brace Shape and Size	Area (in. ²)	Least Radius of Gyration <i>r</i> (in.)	Maximum Length for:				30° to Angle f Vertic
			ft	ft	in.		

Table 9.3.5.8.8(b) Maximum Horizontal Loads for Sway Braces with $l/r = 200$ for S

Brace Shape and Size	Area (in. ²)	Least Radius of Gyration <i>r</i> (in.)	Maximum Length for:				30° to Angle f Vertic
			$l/r = 200$				
			ft	ft	in.		
Pipe Schedule 40	1 in.	0.494	0.421	7.0	7 ft	0 in.	1227
	1¼ in.	0.669	0.54	9.0	9 ft	0 in.	1661
	1½ in.	0.799	0.623	10.4	10 ft	4 in.	1984
	2 in.	1.07	0.787	13.1	13 ft	1 in.	2657
Angles	1½ × 1½ × ¼ in.	0.688	0.292	4.9	4 ft	10 in.	1708
	2 × 2 × ¼ in.	0.938	0.391	6.5	6 ft	6 in.	2329
	2½ × 2 × ¼ in.	1.06	0.424	7.1	7 ft	0 in.	2632
	2½ × 2½ × ¼ in.	1.19	0.491	8.2	8 ft	2 in.	2955
	3 × 2½ × ¼ in.	1.31	0.528	8.8	8 ft	9 in.	3252
	3 × 3 × ¼ in.	1.44	0.592	9.9	9 ft	10 in.	3575
Rods (all thread)	⅜ in.	0.07	0.075	1.2	1 ft	2 in.	174
	½ in.	0.129	0.101	1.7	1 ft	8 in.	320
	⅝ in.	0.207	0.128	2.1	2 ft	1 in.	514
	¾ in.	0.309	0.157	2.6	2 ft	7 in.	767
	⅞ in.	0.429	0.185	3.1	3 ft	0 in.	1065
Rods (threaded at ends only)	⅜ in.	0.11	0.094	1.6	1 ft	6 in.	273
	½ in.	0.196	0.125	2.1	2 ft	0 in.	487
	⅝ in.	0.307	0.156	2.6	2 ft	7 in.	762
	¾ in.	0.442	0.188	3.1	3 ft	1 in.	1097
	⅞ in.	0.601	0.219	3.6	3 ft	7 in.	1492
Flats	1½ × ¼ in.	0.375	0.0722	1.2	1 ft	2 in.	931
	2 × ¼ in.	0.5	0.0722	1.2	1 ft	2 in.	1241
	2 × ⅜ in.	0.75	0.1082	1.8	1 ft	9 in.	1862

Table 9.3.5.8.8(c) Maximum Horizontal Loads for Sway Braces with $l/r = 300$

Brace Shape and Size	Area (in. ²)	Least Radius of Gyration <i>r</i> (in.)	Maximum Length for:				30° to Angle f Vertic
			$l/r = 300$				

Brace Shape and Size	(in. ²)	Gyration <i>r</i> (in.)	ft	ft	in.	Vertic
----------------------	---------------------	-------------------------	----	----	-----	--------

Table 9.3.5.8.8(c) Maximum Horizontal Loads for Sway Braces with $l/r = 30$

Brace Shape and Size	Area (in. ²)	Least Radius of Gyration <i>r</i> (in.)	Maximum Length for: $l/r = 300$			30° to Angle from	
			ft	ft	in.		
Pipe Schedule 40	1 in.	0.494	0.421	10.5	10 ft	6 in.	54
	1¼ in.	0.669	0.54	13.5	13 ft	6 in.	73
	1½ in.	0.799	0.623	15.6	15 ft	6 in.	88
	2 in.	1.07	0.787	19.7	19 ft	8 in.	118
Angles	1½ × 1½ × ¼ in.	0.688	0.292	7.3	7 ft	3 in.	75
	2 × 2 × ¼ in.	0.938	0.391	9.8	9 ft	9 in.	107
	2½ × 2 × ¼ in.	1.06	0.424	10.6	10 ft	7 in.	117
	2½ × 2½ × ¼ in.	1.19	0.491	12.3	12 ft	3 in.	137
	3 × 2½ × ¼ in.	1.31	0.528	13.2	13 ft	2 in.	147
	3 × 3 × ¼ in.	1.44	0.592	14.8	14 ft	9 in.	157
Rods (all thread)	¾ in.	0.07	0.075	1.9	1 ft	10 in.	77
	½ in.	0.129	0.101	2.5	2 ft	6 in.	14
	⅝ in.	0.207	0.128	3.2	3 ft	2 in.	22
	¾ in.	0.309	0.157	3.9	3 ft	11 in.	34
	⅞ in.	0.429	0.185	4.6	4 ft	7 in.	47
Rods (threaded at ends only)	¾ in.	0.11	0.094	2.3	2 ft	4 in.	12
	½ in.	0.196	0.125	3.1	3 ft	1 in.	21
	⅝ in.	0.307	0.156	3.9	3 ft	10 in.	33
	¾ in.	0.442	0.188	4.7	4 ft	8 in.	48
	⅞ in.	0.601	0.219	5.5	5 ft	5 in.	66
Flats	1½ × ¼ in.	0.375	0.0722	1.8	1 ft	9 in.	41
	2 × ¼ in.	0.5	0.0722	1.8	1 ft	9 in.	55
	2 × ⅜ in.	0.75	0.1082	2.7	2 ft	8 in.	82

9.3.5.8.9* Other pipe schedules and materials not specifically included in Table 9.3.5.8.8(a), Table 9.3.5.8.8(b), and Table 9.3.5.8.8(c) shall be permitted to be used if certified by a registered professional engineer to support the loads determined in accordance with the above criteria. Calculations shall be submitted where required by the authority having jurisdiction.

9.3.5.9* Fasteners.

9.3.5.9.1 For individual fasteners, the loads determined in 9.3.5.6 shall not exceed the allowable loads provided in Figure 9.3.5.9.1.

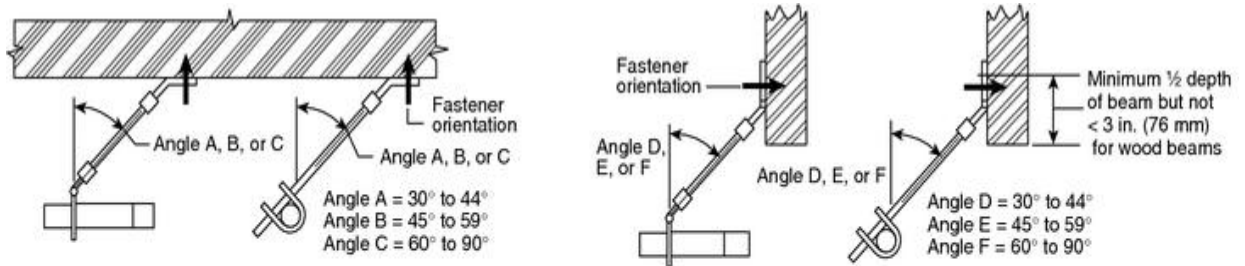

Load Perpendicular to Structural Member

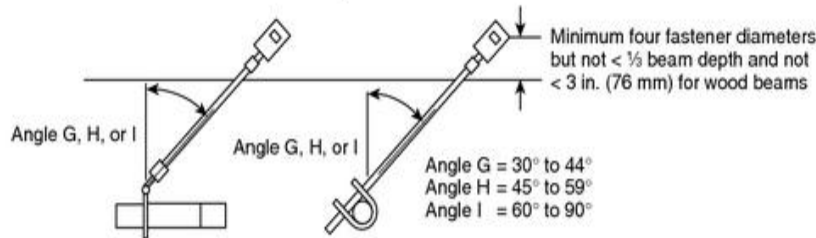

Load Parallel to Structural Member

Wedge Anchors in Normal Weight Concrete										
Diameter (in.)	Embedment (in.)	A	B	C	D	E	F	G	H	I
3/8	3	120	290	615	540	465	410	385	545	665
1/2	4	210	510	1085	955	825	720	690	975	1195
5/8	5	300	730	1550	1415	1200	1035	1085	1530	1875
3/4	6	385	945	2005	1920	1600	1335	1800	2545	3120

Wedge Anchors in Lightweight Concrete Filled Metal Decking										
Diameter (in.)	Embedment (in.)	A	B	C	D	E	F	G	H	I
3/8	1 1/4	75	175	375	—	—	—	—	—	—
1/2	2 1/4	100	245	520	—	—	—	—	—	—
5/8	2 1/4	150	370	780	—	—	—	—	—	—
3/4	3 1/4	160	390	825	—	—	—	—	—	—

Undercut Anchors in Normal Weight Concrete										
Diameter (mm)	Embedment (in.)	A	B	C	D	E	F	G	H	I
M10	4	305	745	1125	1165	1105	1050	650	920	1125
M12	5	460	1130	1645	1740	1665	1595	950	1345	1645
M16	7 1/2	825	2020	2930	3110	2980	2860	1695	2395	2930

Connections to Steel (Values Assume Bolt Perpendicular to Mounting Surface)																			
Diameter of Unfinished Steel Bolt (in.)																			
1/4										3/8									
A	B	C	D	E	F	G	H	I	A	B	C	D	E	F	G	H	I	A	B
400	500	600	300	500	650	325	458	565	900	1200	1400	800	1200	1550	735	1035	1278		
Diameter of Unfinished Steel Bolt (in.)																			
1/2										3/4									
A	B	C	D	E	F	G	H	I	A	B	C	D	E	F	G	H	I	A	B
1600	2050	2550	1450	2050	2850	1300	1630	2260	2500	3300	3950	2250	3300	4400	2045	2880	3557		

Note: These are minimum values to be used for generic anchors in normal weight concrete slabs, lightweight concrete metal filled decking, and a table for undercut anchors in normal weight concrete. Anchors with special listings shall be installed in accordance with their requirements.

Through-Bolts in Sawn Lumber or Glue-Laminated Timbers (Load Perpendicular to Grain)																											
Length of Bolt in Timber (in.)	Bolt Diameter (in.)																										
	1/2									3/4									3/8								
	A	B	C	D	E	F	G	H	I	A	B	C	D	E	F	G	H	I	A	B							
1 1/2	115	165	200	135	230	395	130	215	310	135	190	235	155	270	460	155	255	380	155	220	270	180	310	530	170	300	450
2 1/2	140	200	240	160	280	480	165	275	410	160	225	280	185	320	550	190	320	495	180	255	310	205	360	615	215	365	575
3 1/2	175	250	305	200	350	600	200	330	485	200	285	345	230	400	685	235	405	635	220	310	380	255	440	755	260	455	730
5 1/2	—	—	—	—	—	—	—	—	—	280	395	485	325	560	960	315	515	735	310	440	535	360	620	1065	360	610	925

Lag Screws and Lag Bolts in Wood (Load Perpendicular to Grain — Holes Predrilled Using Good Practice)																											
Length Under Head (in.)	Lag Bolt Diameter (in.)																										
	3/8									1/2									3/4								
	A	B	C	D	E	F	G	H	I	A	B	C	D	E	F	G	H	I	A	B							
3 1/2	165	190	200	170	220	310	80	120	170	—	—	—	—	—	—	—	—	—	—	—	—	—	—	—	—	—	—
4 1/2	180	200	200	175	235	350	80	120	170	300	355	380	315	400	550	145	230	325	—	—	—	—	—	—	—	—	—
5 1/2	190	200	200	175	245	380	80	120	170	320	370	380	320	420	610	145	230	325	435	525	555	425	550	775	195	320	460
6 1/2	195	205	200	175	250	400	80	120	170	340	375	380	325	435	650	145	230	325	465	540	555	430	570	840	195	320	460

Note: Wood fastener maximum capacity values are based on 2001 National Design Specifications (NDS) for wood with a specific gravity of 0.35. Values for other types of wood can be obtained by multiplying the above values by the following factors:

Specific Gravity of Wood	Multiplier
0.36 thru 0.49	1.17
0.50 thru 0.65	1.25
0.66 thru 0.73	1.50

For SI values, 1 in. = 25.4 mm.

FIGURE 9.3.5.9.1 Maximum Loads for Various Types of Structure and Maximum Loads for Various Types of Fasteners to Structure.

9.3.5.9.2 The type of fasteners used to secure the bracing assembly to the structure shall be limited to those shown in Figure 9.3.5.9.1 or to listed devices.

9.3.5.9.3* For connections to wood, through-bolts with washers on each end shall be used, unless the requirements of 9.3.5.9.4 are met.

9.3.5.9.4 Where it is not practical to install through-bolts due to the thickness of the member or inaccessibility, lag screws shall be permitted. Holes shall be pre-drilled $\frac{1}{8}$ in. (3.2 mm) smaller than the maximum root diameter of the lag screw.

9.3.5.9.5 Holes for through-bolts shall be $\frac{1}{16}$ in. (1.6 mm) greater than the diameter of the bolt.

9.3.5.9.6 The requirements of 9.3.5.9 shall not apply to other fastening methods, which shall be acceptable for use if certified by a registered professional engineer to support the loads determined in accordance with the criteria in 9.3.5.6. Calculations shall be submitted where required by the authority having jurisdiction.

9.3.5.9.7* Concrete anchors other than those shown in Figure 9.3.5.9.1 shall be acceptable for use where designed in accordance with the requirements of the building code and certified by a registered professional engineer.

9.3.5.10 Assemblies.

9.3.5.10.1 Sway bracing assemblies shall be listed for a maximum load rating, unless the requirements of 9.3.5.10.2 are met.

9.3.5.10.2 Where sway bracing utilizing pipe, angles, flats, or rods as shown in Table 9.3.5.8.8(a), Table 9.3.5.8.8(b), and Table 9.3.5.8.8(c) is used, the components do not require listing. Bracing fittings and connections used with those specific materials shall be listed.

9.3.5.10.3 The loads shall be reduced as shown in Table 9.3.5.10.3 for loads that are less than 90 degrees from vertical.

Table 9.3.5.10.3 Allowable Horizontal Load on Brace Assemblies Based on the Weakest Component of the Brace Assembly

Brace Angle	Allowable Horizontal Load
30 to 44 degrees from vertical	Listed load rating divided by 2.000
45 to 59 degrees from vertical	Listed load rating divided by 1.414
60 to 89 degrees from vertical	Listed load rating divided by 1.155
90 degrees from vertical	Listed load rating

9.3.5.11 Attachments.

9.3.5.11.1 Bracing shall be attached directly to feed and cross mains.

9.3.5.11.2 Each run of pipe between changes in direction shall be provided with both lateral and longitudinal bracing, unless the requirements of 9.3.5.11.3 are met.

9.3.5.11.3 Pipe runs less than 12 ft (3.7 m) in length shall be permitted to be supported by the braces on adjacent runs of pipe.

9.3.5.12 Braces to Buildings with Differential Movement. A length of pipe shall not be braced to sections of the building that will move differentially.

9.3.6 Restraint of Branch Lines.

9.3.6.1* Restraint is considered a lesser degree of resisting loads than bracing and shall be provided by use of one of the following:

- (1) A listed sway brace assembly
- (2) A wraparound U-hook satisfying the requirements of 9.3.5.3.9
- (3) No. 12, 440 lb (200 kg) wire installed at least 45 degrees from the vertical plane and anchored on both sides of the pipe
- (4) Other approved means
- (5)* A hanger not less than 45 degrees from vertical installed within 6 in. (152 mm) of the vertical hanger arranged for restraint against upward movement, provided it is utilized such that l/r does not exceed 300, where the rod shall extend to the pipe or have a surge clip installed

9.3.6.2 Wire used for restraint shall be located within 2 ft (610 mm) of a hanger. The hanger closest to a wire restraint shall be of a type that resists upward movement of a branch line.

9.3.6.3 The end sprinkler on a line shall be restrained against excessive vertical and lateral movement.

9.3.6.4* Branch lines shall be laterally restrained at intervals not exceeding those specified in Table 9.3.6.4 based on branch line diameter and the value of C_p .

Table 9.3.6.4 Maximum Spacing of Branch Line Restraints, (feet)

Pipe (in.)	Seismic Coefficient, C_p		
	$C_p < 0.50$	$0.5 < C_p < 0.71$	$C_p > 0.71$
		.71	
1	45	38	27
1¼	48	40	28
1½	51	43	30
2	55	46	33

9.3.6.5 Where the branch lines are supported by rods less than 6 in. (152 mm) long measured between the top of the pipe and the point of attachment to the building structure, the requirements of 9.3.6.1 through 9.3.6.4 shall not apply and additional restraint shall not be required for the branch lines.

9.3.6.6* Sprigs 4 ft (1.2 m) or longer shall be restrained against lateral movement.

9.3.7 Hangers and Fasteners Subject to Earthquakes.

9.3.7.1 C-type clamps (including beam and large flange clamps) used to attach hangers to the building structure in areas subject to earthquakes shall be equipped with a restraining strap.

9.3.7.2 The restraining strap shall be listed for use with a C-type clamp or shall be a steel strap of not less than 16 gauge (1.59 mm) thickness and not less than 1 in. (25.4 mm) wide for pipe diameters 8 in. (200 mm) or less and 14 gauge (0.98 mm) thickness and not less than 1¼ in. (31.7 mm) wide for pipe diameters greater than 8 in. (200 mm).

9.3.7.3 The restraining strap shall wrap around the beam flange not less than 1 in. (25.4 mm).

9.3.7.4 A lock nut on a C-type clamp shall not be used as a method of restraint.

9.3.7.5 A lip on a “C” or “Z” purlin shall not be used as a method of restraint.

9.3.7.6 Where purlins or beams do not provide an adequate lip to be secured by a restraining strap, the strap shall be through-bolted or secured by a self-tapping screw.

9.3.7.7 C-type clamps (including beam and large flange clamps), with or without restraining straps, shall not be used to attach braces to the building structure.

9.3.7.8 Powder-driven fasteners shall not be used to attach braces to the building structure, unless they are specifically listed for service in resisting lateral loads in areas subject to earthquakes.

9.3.7.9 In areas where the horizontal force factor exceeds 0.50 W_p , powder-driven studs shall be permitted to attach hangers to the building structure where they are specifically listed for use in areas subject to earthquakes.

Chapter 10 Underground Piping

10.1* Piping Materials. [24:10.1]

10.1.1* Listing. Piping shall be listed for fire protection service and shall comply with the standards in Table 10.1.1. [24:10.1.1]

Table 10.1.1 Manufacturing Standards for Underground Pipe

Materials and Dimensions	Standard
---------------------------------	-----------------

Table 10.1.1 Manufacturing Standards for Underground Pipe

Materials and Dimensions	Standard
Ductile Iron	
Cement Mortar Lining for Ductile Iron Pipe and Fittings for Water	AWWA C104
Polyethylene Encasement for Ductile Iron Pipe Systems	AWWA C105
Ductile Iron and Gray Iron Fittings, 3-in. Through 48-in., for Water and Other Liquids	AWWA C110
Rubber-Gasket Joints for Ductile Iron Pressure Pipe and Fittings	AWWA C111
Flanged Ductile Iron Pipe with Ductile Iron or Gray Iron Threaded Flanges	AWWA C115
Protective Fusion-Bonded Epoxy Coatings for the Interior and Exterior Surfaces of Ductile-Iron and Gray-Iron Fittings for Water Supply Service	AWWA C116
Thickness Design of Ductile Iron Pipe	AWWA C150
Ductile Iron Pipe, Centrifugally Cast for Water	AWWA C151
Ductile-Iron Compact Fittings for Water Service	AWWA C153
Standard for the Installation of Ductile Iron Water Mains and Their Appurtenances	AWWA C600
Steel	
Steel Water Pipe 6 in. and Larger	AWWA C200
Coal-Tar Protective Coatings and Linings for Steel Water Pipelines Enamel and Tape — Hot Applied	AWWA C203
Cement-Mortar Protective Lining and Coating for Steel Water Pipe 4 in. and Larger — Shop Applied	AWWA C205
Field Welding of Steel Water Pipe	AWWA C206
Steel Pipe Flanges for Waterworks Service — Sizes 4 in. Through 144 in.	AWWA C207
Dimensions for Fabricated Steel Water Pipe Fittings	AWWA C208
A Guide for Steel Pipe Design and Installation	AWWA M11
Concrete	
Reinforced Concrete Pressure Pipe, Steel-Cylinder Type, for Water and Other Liquids	AWWA C300
Prestressed Concrete Pressure Pipe, Steel-Cylinder Type, for Water and Other Liquids	AWWA C301
Reinforced Concrete Pressure Pipe, Non-Cylinder Type, for Water and Other Liquids	AWWA C302
Reinforced Concrete Pressure Pipe, Steel-Cylinder Type, Pretensioned, for Water and Other Liquids	AWWA C303
Standard for Asbestos-Cement Distribution Pipe, 4 in. Through 16 in., for Water and Other Liquids	AWWA C400
Standard Practice for Selection of Asbestos-Cement Water Pipe	AWWA C401
Cement-Mortar Lining of Water Pipe Lines 4 in. and Larger — in Place	AWWA C602
Standard for the Installation of Asbestos-Cement Water Pipe	AWWA C603
Plastic	
Polyvinyl Chloride (PVC) Pressure Pipe, 4 in. Through 12 in., for Water and Other Liquids	AWWA C900
Polyethylene (PE) Pressure Pipe and Fittings 4 in. (100 mm) through 63 in. (1575 mm) for Water Distribution and Transport	AWWA C906

Table 10.1.1 Manufacturing Standards for Underground Pipe

Materials and Dimensions	Standard
Copper	
Specification for Seamless Copper Tube	ASTM B 75
Specification for Seamless Copper Water Tube	ASTM B 88
Requirements for Wrought Seamless Copper and Copper-Alloy Tube	ASTM B 251

[24: Table 10.1.1]

10.1.2 Steel Pipe. Steel piping shall not be used for general underground service unless specifically listed for such service. [24:10.1.2]

10.1.3 Steel Pipe Used with Fire Department Connections. Where externally coated and wrapped and internally galvanized, steel pipe shall be permitted to be used between the check valve and the outside hose coupling for the fire department connection. [24:10.1.3]

10.1.4* Pipe Type and Class. The type and class of pipe for a particular underground installation shall be determined through consideration of the following factors:

- (1) Fire resistance of the pipe
- (2) Maximum system working pressure
- (3) Depth at which the pipe is to be installed
- (4) Soil conditions
- (5) Corrosion
- (6) Susceptibility of pipe to other external loads, including earth loads, installation beneath buildings, and traffic or vehicle loads [24:10.1.4]

10.1.5 Working Pressure. Pipe shall be designed to withstand a system working pressure of not less than 150 psi (10.3 bar). [24:10.1.5]

10.1.6* Lining of Buried Pipe. [24:10.1.6]

10.1.6.1 Unless the requirements of 10.1.6.2 are met, all ferrous metal pipe shall be lined in accordance with the applicable standards in Table 10.1.1. [24:10.1.6.1]

10.1.6.2 Steel pipe utilized in fire department connections and protected in accordance with the requirements of 10.1.3 shall not be additionally required to be lined. [24:10.1.6.2]

10.2 Fittings. [24:10.2]

10.2.1 Standard Fittings. Fittings shall meet the standards in Table 10.2.1(a) or shall be in accordance with 10.2.2. In addition to the standards in Table 10.2.1(b), CPVC fittings shall also be in accordance with 10.2.2 and with the portions of the ASTM standards specified in

10.2 Fittings. [24:10.2]

10.2.1 Standard Fittings. Fittings shall meet the standards in Table 10.2.1(a) or shall be in accordance with 10.2.2. In addition to the standards in Table 10.2.1(b), CPVC fittings shall also be in accordance with 10.2.2 and with the portions of the ASTM standards specified in Table 10.2.1(b) that apply to fire protection service. [24:10.2.1]

Table 10.2.1(a) Fittings Materials and Dimensions	
Materials and Dimensions	Standard
Cast Iron	
Cast Iron Threaded Fittings, Class 125 and 250	ASME B16.4
Cast Iron Pipe Flanges and Flanged Fittings	ASME B16.1
Malleable Iron	
Malleable Iron Threaded Fittings, Class 150 and 300	ASME B16.3
Steel	
Factory-Made Wrought Steel Buttweld Fittings	ASME B16.9
Buttwelding Ends for Pipe, Valves, Flanges, and Fittings	ASME B16.25
Specification for Piping Fittings of Wrought Carbon Steel and Alloy Steel for Moderate and Elevated Temperatures	ASTM A 234
Steel Pipe Flanges and Flanged Fittings	ASME B16.5
Forged Steel Fittings, Socket Welded and Threaded	ASME B16.11
Copper	
Wrought Copper and Bronze Solder Joint Pressure Fittings	ASME B16.22
Cast Bronze Solder Joint Pressure Fittings	ASME B16.18

[24: Table 10.2.1(a)]

**Table 10.2.1(b) Specially Listed Fittings
Materials and Dimensions**

Materials and Dimensions	Standard
Chlorinated Polyvinyl Chloride (CPVC) Specification for Schedule 80 CPVC Threaded Fittings	ASTM F 437
Specification for Schedule 40 CPVC Socket-Type Fittings	ASTM F 438
Specification for Schedule 80 CPVC Socket-Type Fittings	ASTM F 439

[24: Table 10.2.1(b)]

10.2.2 Special Listed Fittings. Other types of fittings investigated for suitability in automatic sprinkler installations and listed for this service, including, but not limited to, polybutylene, CPVC, and steel differing from that provided in Table 10.2.1(a), shall be permitted when installed in accordance with their listing limitations, including installation instructions. [24:10.2.2]

10.2.3 Pressure Limits. Listed fittings shall be permitted for system pressures as specified in their listings, but not less than 150 psi (10 bar). [24:10.2.3]

10.2.4* Buried Joints. Joints shall be approved. [24:10.2.4]

10.2.5* Buried Fittings. Fittings shall be of an approved type with joints and pressure class ratings compatible with the pipe used. [24:10.2.5]

10.3 Joining of Pipe and Fittings. [24:10.3]

10.3.1 Threaded Pipe and Fittings. All threaded steel pipe and fittings shall have threads cut in accordance with ASME B1.20.1, *Pipe Threads, General Purpose (Inch)*. [24:10.3.1]

10.3.2 Groove Joining Methods. Pipes joined with grooved fittings shall be joined by a listed combination of fittings, gaskets, and grooves. [24:10.3.2]

10.3.3 Brazed and Pressure Fitting Methods. Joints for the connection of copper tube shall be brazed or joined using pressure fittings as specified in Table 10.2.1(a). [24:10.3.3]

10.3.4 Other Joining Methods. Other joining methods listed for this service shall be permitted where installed in accordance with their listing limitations. [24:10.3.4]

10.3.5 Pipe Joint Assembly. [24:10.3.5]

10.3.5.1 Joints shall be assembled by persons familiar with the particular materials being used and in accordance with the manufacturer's instructions and specifications. [24:10.3.5.1]

10.3.5.2 All bolted joint accessories shall be cleaned and thoroughly coated with asphalt or other corrosion-retarding material after installation. [24:10.3.5.2]

10.4 Depth of Cover.[24:10.4]

10.4.1* The depth of cover over water pipes shall be determined by the maximum depth of frost penetration in the locality where the pipe is laid. [24:10.4.1]

10.4.2 The top of the pipe shall be buried not less than 1 ft (0.3 m) below the frost line for the locality. [24:10.4.2]

10.4.3 In those locations where frost is not a factor, the depth of cover shall be not less than 2½ ft (0.8 m) to prevent mechanical damage. [24:10.4.3]

10.4.4 Pipe under driveways shall be buried a minimum of 3 ft (0.9 m). [24:10.4.4]

10.4.5 Pipe under railroad tracks shall be buried at a minimum of 4 ft (1.2 m). [24:10.4.5]

10.4.6 The depth of cover shall be measured from the top of the pipe to finished grade, and due consideration shall always be given to future or final grade and nature of soil. [24:10.4.6]

10.5 Protection Against Freezing. [24:10.5]

10.5.1* Where it is impracticable to bury pipe, pipe shall be permitted to be laid aboveground, provided the pipe is protected against freezing and mechanical damage. [24:10.5.1]

10.5.2 Pipe shall be buried below the frost line where entering streams and other bodies of water. [24:10.5.2]

10.5.3 Where pipe is laid in water raceways or shallow streams, care shall be taken that there will be sufficient depth of running water between the pipe and the frost line during all seasons of frost; a safer method is to bury the pipe 1 ft (0.3048 m) or more under the bed of the waterway. [24:10.5.3]

10.5.4 Pipe shall be located at a distance from stream banks and embankment walls that prevents danger of freezing through the side of the bank. [24:10.5.4]

10.6 Protection Against Damage. [24:10.6]

10.6.1 Pipe shall not be run under buildings. [24:10.6.1]

10.6.2 Where pipe must be run under buildings, special precautions shall be taken, including the following:

- (1) Arching the foundation walls over the pipe
- (2) Running pipe in covered trenches
- (3) Providing valves to isolate sections of pipe under buildings [24:10.6.2]

10.6.3 Fire service mains shall be permitted to enter the building adjacent to the foundation. [24:10.6.3]

10.6.4 Where adjacent structures or physical conditions make it impractical to locate risers

immediately inside an exterior wall, such risers shall be permitted to be located as close as practical to exterior walls to minimize underground piping under the building. [24:10.6.4]

10.6.5 Where a riser is close to building foundations, underground fittings of proper design and type shall be used to avoid pipe joints being located in or under the foundations. [24:10.6.5]

10.6.6 Mains shall be subjected to an evaluation of the following specific loading conditions and protected, if necessary:

- (1) Mains running under railroads carrying heavy cargo
- (2) Mains running under large piles of heavy commodities
- (3) Mains located in areas that subject the main to heavy shock and vibrations [24:10.6.6]

10.6.7* Where it is necessary to join metal pipe with pipe of dissimilar metal, the joint shall be insulated against the passage of an electric current using an approved method. [24:10.6.7]

10.6.8* In no case shall the underground piping be used as a grounding electrode for electrical systems. This does not preclude the bonding of the underground piping to the lightning protection grounding system as required by NFPA 780 in those cases where lightning protection is provided for the structure. [24:10.6.8]

10.7 Requirement for Laying Pipe [24:10.7]

10.7.1 Pipes, valves, hydrants, gaskets, and fittings shall be inspected for damage when received and shall be inspected prior to installation. (*See Figure 10.10.1.*) [24:10.7.1]

10.7.2 The torquing of bolted joints shall be checked. [24:10.7.2]

10.7.3 Pipe, valves, hydrants, and fittings shall be clean inside. [24:10.7.3]

10.7.4 When work is stopped, the open ends of pipe, valves, hydrants, and fittings shall be plugged to prevent stones and foreign materials from entering. [24:10.7.4]

10.7.5 All pipe, fittings, valves, and hydrants shall be carefully lowered into the trench using appropriate equipment and carefully examined for cracks or other defects while suspended above the trench. [24:10.7.5]

10.7.6 Plain ends shall be inspected for signs of damage prior to installation. [24:10.7.6]

10.7.7 Under no circumstances shall water main materials be dropped or dumped. [24:10.7.7]

10.7.8 Pipe shall not be rolled or skidded against other pipe materials. [24:10.7.8]

10.7.9 Pipes shall bear throughout their full length and shall not be supported by the bell ends only or by blocks. [24:10.7.9]

10.7.10 If ground is soft, or of a quicksand nature, special provisions shall be made for supporting pipe. [24:10.7.10]

10.7.11 Valves and fittings used with nonmetallic pipe shall be properly supported and

restrained in accordance with the manufacturer's specifications. [24:10.7.11]

10.8 Joint Restraint. [24:10.8]

10.8.1 General. [24:10.8.1]

10.8.1.1* All tees, plugs, caps, bends, reducers, valves, and hydrant branches shall be restrained against movement by using thrust blocks in accordance with 10.8.2 or restrained joint systems in accordance with 10.8.3. [24:10.8.1.1]

10.8.1.2 Piping with fused, threaded, grooved, or welded joints shall not require additional restraining, provided that such joints can pass the hydrostatic test of 10.10.2.2 without shifting of piping or leakage in excess of permitted amounts. [24:10.8.1.2]

10.8.1.3 Steep Grades. On steep grades, mains shall be additionally restrained to prevent slipping. [24:10.8.1.3]

10.8.1.3.1 Pipe shall be restrained at the bottom of a hill and at any turns (lateral or vertical). [24:10.8.1.3.1]

10.8.1.3.2 The restraint specified in 10.8.1.3.1 shall be to natural rock or to suitable piers built on the downhill side of the bell. [24:10.8.1.3.2]

10.8.1.3.3 Bell ends shall be installed facing uphill. [24:10.8.1.3.3]

10.8.1.3.4 Straight runs on hills shall be restrained as determined by the design engineer. [24:10.8.1.3.4]

10.8.2* Thrust Blocks [24:10.8.2]

10.8.2.1 Thrust blocks shall be considered satisfactory where soil is suitable for their use. [24:10.8.2.1]

10.8.2.2 Thrust blocks shall be of a concrete mix not leaner than one part cement, two and one-half parts sand, and five parts stone. [24:10.8.2.2]

10.8.2.3 Thrust blocks shall be placed between undisturbed earth and the fitting to be restrained and shall be capable of such bearing to ensure adequate resistance to the thrust to be encountered. [24:10.8.2.3]

10.8.2.4 Wherever possible, thrust blocks shall be placed so that the joints are accessible for repair. [24:10.8.2.4]

10.8.3* Restrained Joint Systems. Fire mains utilizing restrained joint systems shall include one or more of the following:

- (1) Locking mechanical or push-on joints
- (2) Mechanical joints utilizing setscrew retainer glands
- (3) Bolted flange joints
- (4) Heat-fused or welded joints
- (5) Pipe clamps and tie rods

(6) Other approved methods or devices [24:10.8.3]

10.8.3.1 Sizing Clamps, Rods, Bolts, and Washers [24:10.8.3.1]

10.8.3.1.1 Clamps. [24:10.8.3.1.1]

10.8.3.1.1.1 Clamps shall have the following dimensions:

- (1) $\frac{1}{2}$ in. \times 2 in. (12.7 mm \times 50.8 mm) for pipe 4 in. to 6 in.
- (2) $\frac{5}{8}$ in. \times 2 $\frac{1}{2}$ in. (15.9 mm \times 63.5 mm) for pipe 8 in. to 10 in.
- (3) $\frac{3}{8}$ in. \times 3 in. (15.9 mm \times 76.2 mm) for 12 in. pipe [24:10.8.3.1.1.1]

10.8.3.1.1.2 The diameter of a bolt hole shall be $\frac{1}{16}$ in. (1.6 mm) larger than that of the corresponding bolts. [24:10.8.3.1.1.2]

10.8.3.1.2 Rods. [24:10.8.3.1.2]

10.8.3.1.2.1 Rods shall be not less than $\frac{5}{8}$ in. (15.9 mm) in diameter. [24:10.8.3.1.2.1]

10.8.3.1.2.2 Table 10.8.3.1.2.2 provides numbers of various diameter rods that shall be used for a given pipe size. [24:10.8.3.1.2.2]

Table 10.8.3.1.2.2 Rod Number — Diameter Combinations

Nominal Pipe Size (in.)	$\frac{5}{8}$ in. (15.9 mm)	$\frac{3}{4}$ in. (19.1 mm)	$\frac{7}{8}$ in. (22.2 mm)	1 in. (25.4 mm)
4	2	—	—	—
6	2	—	—	—
8	3	2	—	—
10	4	3	2	—
12	6	4	3	2
14	8	5	4	3
16	10	7	5	4

Note: This table has been derived using pressure of 225 psi (15.5 bar) and design stress of 25,000 psi (172.4 MPa).

[24: Table 10.8.3.1.2.2]

10.8.3.1.2.3 When using bolting rods, the diameter of mechanical joint bolts shall limit the diameter of rods to $\frac{3}{4}$ in. (19.1 mm). [24:10.8.3.1.2.3]

10.8.3.1.2.4 Threaded sections of rods shall not be formed or bent. [24:10.8.3.1.2.4]

10.8.3.1.2.5 Where using clamps, rods shall be used in pairs for each clamp.

[24:10.8.3.1.2.5]

10.8.3.1.2.6 Assemblies in which a restraint is made by means of two clamps canted on the barrel of the pipe shall be permitted to use one rod per clamp if approved for the specific

installation by the authority having jurisdiction. [24:10.8.3.1.2.6]

10.8.3.1.2.7 Where using combinations of rods, the rods shall be symmetrically spaced. [24:10.8.3.1.2.7]

10.8.3.1.3 Clamp Bolts. Clamp bolts shall have the following diameters:

- (1) $\frac{5}{8}$ in. (15.9 mm) for pipe 4 in., 6 in., and 8 in.
- (2) $\frac{3}{4}$ in. (19.1 mm) for pipe 10 in.
- (3) $\frac{7}{8}$ in. (22.2 mm) for 12 in. pipe [24:10.8.3.1.3]

10.8.3.1.4 Washers. [24:10.8.3.1.4]

10.8.3.1.4.1 Washers shall be permitted to be cast iron or steel and round or square. [24:10.8.3.1.4.1]

10.8.3.1.4.2 Cast-iron washers shall have the following dimensions:

- (1) $\frac{5}{8}$ in. \times 3 in. (15.9 mm \times 76.2 mm) for 4 in., 6 in., 8 in., and 10 in. pipe
- (2) $\frac{3}{4}$ in. \times 3 $\frac{1}{2}$ in. (19.1 mm \times 88.9 mm) for 12 in. pipe [24:10.8.3.1.4.2]

10.8.3.1.4.3 Steel washers shall have the following dimensions:

- (1) $\frac{1}{2}$ in. \times 3 in. (12.7 mm \times 76.2 mm) for 4 in., 6 in., 8 in., and 10 in. pipe
- (2) $\frac{1}{2}$ in. \times 3 $\frac{1}{2}$ in. (12.7 mm \times 88.9 mm) for 12 in. pipe [24:10.8.3.1.4.3]

10.8.3.1.4.4 The diameter of holes shall be $\frac{1}{8}$ in. (3.2 mm) larger than that of rods. [24:10.8.3.1.4.4]

10.8.3.2 Sizes of Restraint Straps for Tees. [24:10.8.3.2]

10.8.3.2.1 Restraint straps for tees shall have the following dimensions:

- (1) $\frac{5}{8}$ in. (15.9 mm) thick and 2 $\frac{1}{2}$ in. (63.5 mm) wide for 4 in., 6 in., 8 in., and 10 in. pipe
- (2) $\frac{5}{8}$ in. (15.9 mm) thick and 3 in. (76.2 mm) wide for 12 in. pipe [24:10.8.3.2.1]

10.8.3.2.2 The diameter of rod holes shall be $\frac{1}{16}$ in. (1.6 mm) larger than that of rods. [24:10.8.3.2.2]

10.8.3.2.3 Figure 10.8.3.2.3 and Table 10.8.3.2.3 shall be used in sizing the restraint straps for both mechanical and push-on joint tee fittings. [24:10.8.3.2.3]

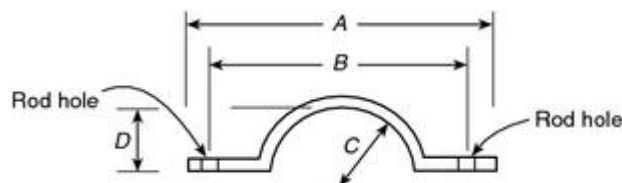

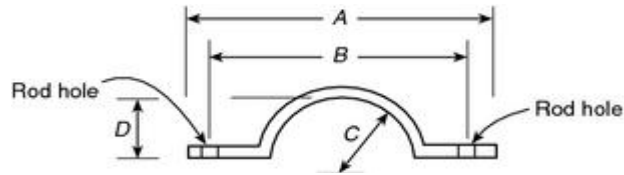

FIGURE 10.8.3.2.3 Restraint Straps for Tees. [24: Figure 10.8.3.2.3]

Table 10.8.3.2.3 Restraint Straps for Tees

Nominal Pipe Size (in.)	A		B		C		
	in.	mm	in.	mm	in.	mm	in.
4	12½	318	10 ¹ / ₈	257	2½	64	1¾
6	14½	368	12 ¹ / ₈	308	3 ⁹ / ₁₆	90	2 ¹³ / ₁₆
8	16¾	425	14 ³ / ₈	365	4 ²¹ / ₃₂	118	3 ²⁹ / ₃₂
10	19 ¹ / ₁₆	484	16 ¹¹ / ₁₆	424	5¾	146	5
12	22 ⁵ / ₁₆	567	19 ³ / ₁₆	487	6¾	171	5 ⁷ / ₈

[24: Table 10.8.3.2.3]

10.8.3.3 Sizes of Plug Strap for Bell End of Pipe. [24:10.8.3.3]

10.8.3.3.1 Strap shall be $\frac{3}{4}$ in. (19.1 mm) thick and $2\frac{1}{2}$ in. (63.5 mm) wide. [24:10.8.3.3.1]

10.8.3.3.2 The strap length shall be the same as dimension *A* for tee straps as shown in Figure 10.8.3.2.3. [24:10.8.3.3.2]

10.8.3.3.3 The distance between the centers of rod holes shall be the same as dimension *B* for tee straps as shown in Figure 10.8.3.2.3. [24:10.8.3.3.3]

10.8.3.4 Material. Clamps, rods, rod couplings or turnbuckles, bolts, washers, restraint straps, and plug straps shall be of a material that has physical and chemical characteristics that indicate its deterioration under stress can be predicted with reliability. [24:10.8.3.4]

10.8.3.5* Corrosion Resistance. After installation, rods, nuts, bolts, washers, clamps, and other restraining devices shall be cleaned and thoroughly coated with a bituminous or other acceptable corrosion-retarding material. [24:10.8.3.5]

10.9 Backfilling. [24:10.9]

10.9.1 Backfill shall be tamped in layers or puddled under and around pipes to prevent settlement or lateral movement and shall contain no ashes, cinders, refuse, organic matter, or other corrosive materials. [24:10.9.1]

10.9.2 Rocks shall not be placed in trenches. [24:10.9.2]

10.9.3 Frozen earth shall not be used for backfilling. [24:10.9.3]

10.9.4 In trenches cut through rock, tamped backfill shall be used for at least 6 in. (150 mm) under and around the pipe and for at least 2 ft (0.6 m) above the pipe. [24:10.9.4]

10.10 Testing and Acceptance. [24:10.10]

10.10.1 Approval of Underground Piping. The installing contractor shall be responsible for the following:

- (1) Notifying the authority having jurisdiction and the owner's representative of the time and date testing is to be performed
- (2) Performing all required acceptance tests
- (3) Completing and signing the contractor's material and test certificate(s) shown in Figure 10.10.1.[24:10.10.1]

Contractor's Material and Test Certificate for Underground Piping

PROCEDURE

Upon completion of work, inspection and tests shall be made by the contractor's representative and witnessed by an owner's representative. All defects shall be corrected and system left in service before contractor's personnel finally leave the job.

A certificate shall be filled out and signed by both representatives. Copies shall be prepared for approving authorities, owners, and contractor. It is understood the owner's representative's signature in no way prejudices any claim against contractor for faulty material, poor workmanship, or failure to comply with approving authority's requirements or local ordinances.

Property name	Date
---------------	------

Property address

Plans	Accepted by approving authorities (names)	
	Address	
	Installation conforms to accepted plans	<input type="checkbox"/> Yes <input type="checkbox"/> No
	Equipment used is approved If no, state deviations	<input type="checkbox"/> Yes <input type="checkbox"/> No

Instructions	Has person in charge of fire equipment been instructed as to location of control valves and care and maintenance of this new equipment? If no, explain	<input type="checkbox"/> Yes <input type="checkbox"/> No
	Have copies of appropriate instructions and care and maintenance charts been left on premises? If no, explain	<input type="checkbox"/> Yes <input type="checkbox"/> No

Location	Supplies buildings
-----------------	--------------------

Underground pipes and joints	Pipe types and class	Type joint
	Pipe conforms to _____ standard	<input type="checkbox"/> Yes <input type="checkbox"/> No
	Fittings conform to _____ standard If no, explain	<input type="checkbox"/> Yes <input type="checkbox"/> No
	Joints needed anchorage clamped, strapped, or blocked in accordance with _____ standard If no, explain	<input type="checkbox"/> Yes <input type="checkbox"/> No

Test description	<p><u>Flushing</u>: Flow the required rate until water is clear as indicated by no collection of foreign material in burlap bags at outlets such as hydrants and blow-offs. Flush at flows not less than 390 gpm (1476 L/min) for 4 in. pipe, 880 gpm (3331 L/min) for 6 in. pipe, 1560 gpm (5905 L/min) for 8 in. pipe, 2440 gpm (9235 L/min) for 10 in. pipe, and 3520 gpm (13,323 L/min) for 12 in. pipe. When supply cannot produce stipulated flow rates, obtain maximum available.</p> <p><u>Hydrostatic</u>: All piping and attached appurtenances subjected to system working pressure shall be hydrostatically tested at 200 psi (13.8 bar) or 50 psi (3.4 bar) in excess of the system working pressure, whichever is greater, and shall maintain that pressure ± 5 psi for 2 hours.</p> <p><u>Hydrostatic Testing Allowance</u>: Where additional water is added to the system to maintain the test pressures required by 10.10.2.2.1, the amount of water shall be measured and shall not exceed the limits of the following equation (For metric equation, see 10.10.2.2.4):</p> $L = \frac{SD\sqrt{P}}{148,000}$ <p style="font-size: small;"> <i>L</i> = testing allowance (makeup water), in gallons per hour <i>S</i> = length of pipe tested, feet <i>D</i> = nominal diameter of the pipe, in inches <i>P</i> = average test pressure during the hydrostatic test, in pounds per square inch (gauge) </p>
-------------------------	---

Flushing tests	New underground piping flushed according to _____ standard by (company) If no, explain		<input type="checkbox"/> Yes <input type="checkbox"/> No
	How flushing flow was obtained <input type="checkbox"/> Public water <input type="checkbox"/> Tank or reservoir <input type="checkbox"/> Fire pump	Through what type opening <input type="checkbox"/> Hydrant butt <input type="checkbox"/> Open pipe	
	Lead-ins flushed according to _____ standard by (company) If no, explain		<input type="checkbox"/> Yes <input type="checkbox"/> No
	How flushing flow was obtained <input type="checkbox"/> Public water <input type="checkbox"/> Tank or reservoir <input type="checkbox"/> Fire pump	Through what type opening <input type="checkbox"/> Y connection to flange and spigot <input type="checkbox"/> Open pipe	

**FIGURE 10.10.1 Sample of Contractor's Material and Test Certificate for
Underground Piping. [24: Figure 10.10.1]**

Hydrostatic test	All new underground piping hydrostatically tested at _____ psi for _____ hours		Joints covered <input type="checkbox"/> Yes <input type="checkbox"/> No		
Leakage test	Total amount of leakage measured _____ gallons _____ hours				
	Allowable leakage _____ gallons _____ hours				
Hydrants	Number installed	Type and make	All operate satisfactorily <input type="checkbox"/> Yes <input type="checkbox"/> No		
	Water control valves left wide open If no, state reason			<input type="checkbox"/> Yes <input type="checkbox"/> No	
Control valves	Hose threads of fire department connections and hydrants interchangeable with those of fire department answering alarm			<input type="checkbox"/> Yes <input type="checkbox"/> No	
	Date left in service				
Remarks					
Signatures	Name of installing contractor				
	Tests witnessed by				
	For property owner (signed)		Title	Date	
	For installing contractor (signed)		Title	Date	
Additional explanation and notes					
<p>© 2006 National Fire Protection Association</p> <p style="text-align: right;">NFPA 13 (p. 2 of 2)</p>					

FIGURE 10.10.1 *Continued*

10.10.2 Acceptance Requirements. [24:10.10.2]

10.10.2.1* Flushing of Piping. [24:10.10.2.1]

10.10.2.1.1 Underground piping, from the water supply to the system riser, and lead-in connections to the system riser shall be completely flushed before connection is made to downstream fire protection system piping. [24:10.10.2.1.1]

10.10.2.1.2 The flushing operation shall be continued for a sufficient time to ensure thorough cleaning. [24:10.10.2.1.2]

10.10.2.1.3 The minimum rate of flow shall be not less than one of the following:

- (1) Hydraulically calculated water demand rate of the system, including any hose requirements
- (2) Flow necessary to provide a velocity of 10 ft/sec (3.1 m/sec) in accordance with Table 10.10.2.1.3
- (3) Maximum flow rate available to the system under fire conditions[24:10.10.2.1.3]

Table 10.10.2.1.3 Flow Required to Produce a Velocity of 10 ft/sec (3 m/sec) in Pipes

Pipe Size		Flow Rate	
in.	mm	gpm	L/min
4	102	390	1476
6	152	880	3331
8	203	1560	5905
10	254	2440	9235
12	305	3520	13323

[24: Table 10.10.2.1.3]

10.10.2.2 Hydrostatic Test. [24:10.10.2.2]

10.10.2.2.1* All piping and attached appurtenances subjected to system working pressure shall be hydrostatically tested at 200 psi (13.8 bar) or 50 psi (3.5 bar) in excess of the system working pressure, whichever is greater, and shall maintain that pressure ± 5 psi for 2 hours. [24:10.10.2.2.1]

10.10.2.2.2 Pressure loss shall be determined by a drop in gauge pressure or visual leakage. [24:10.10.2.2.2]

10.10.2.2.3 The test pressure shall be read from one of the following, located at the lowest elevation of the system or the portion of the system being tested: [24:10.10.2.2.3]

- (1) A gauge located at one of the hydrant outlets
- (2) A gauge located at the lowest point where no hydrants are provided

10.10.2.2.4* Hydrostatic Testing Allowance. Where additional water is added to the system to maintain the test pressures required by 10.10.2.2.1, the amount of water shall be measured and shall not exceed the limits of Table 10.10.2.2.4 which is based upon the following equation:

U.S. Customary Units:

[10.10.2.2.4(a)]
$$L = \frac{SD\sqrt{P}}{148,000}$$

where:

L = testing allowance (makeup water), in gallons per hour

S = length of pipe tested, feet

D = nominal diameter of the pipe, in inches

P = average test pressure during the hydrostatic test, in pounds per square inch (gauge)

Metric Units:

[10.10.2.2.4(b)]
$$L = \frac{SD\sqrt{P}}{794,797}$$

where:

L = testing allowance (makeup water), in liters per hour

S = length of pipe tested, meters

D = nominal diameter of the pipe, in millimeters

P = average test pressure during the hydrostatic test, in kPa

[24:10.10.2.2.4]

Table 10.10.2.2.4 Hydrostatic Testing Allowance at 200 psi per 100 Feet of Pipe

Nominal Pipe Diameter (in.)	Testing Allowance in Gallons per Hour (gph) per 100 ft of Pipe
2	0.019
4	0.038
6	0.057
8	0.076
10	0.096
12	0.115
14	0.134
16	0.153
18	0.172
20	0.191
24	0.229

Table 10.10.2.2.4 Hydrostatic Testing Allowance at 200 psi per 100 Feet of Pipe

Nominal Pipe Diameter (in.)	Testing Allowance in Gallons per Hour (gph) per 100 ft of Pipe
-----------------------------	--

For SI units, 1 in. = 25.4 mm; 1 ft = 305 mm.

Notes:

(1) For other length, diameters, and pressures, Equation 10.10.2.2.4 shall be permitted to be utilized to determine the appropriate testing allowance.

(2) For test sections that contain various sizes and sections of pipe, the testing allowance shall be based upon the sum of the testing allowances for each size and section.

10.10.2.3 Other Means of Hydrostatic Tests. Where required by the authority having jurisdiction, hydrostatic tests shall be permitted to be completed in accordance with the requirements of AWWA C600, AWWA C602, AWWA C603, and AWWA C900.

[24:10.10.2.3]

10.10.2.4 Operating Test. [24:10.10.2.4]

10.10.2.4.1 Each hydrant shall be fully opened and closed under system water pressure.

[24:10.10.2.4.1]

10.10.2.4.2 Dry barrel hydrants shall be checked for proper drainage. [24:10.10.2.4.2]

10.10.2.4.3 All control valves shall be fully closed and opened under system water pressure to ensure proper operation. [24:10.10.2.4.3]

10.10.2.4.4 Where fire pumps are available, the operating tests required by 10.10.2.4 shall be completed with the pumps running. [24:10.10.2.4.4]

10.10.2.5 Backflow Prevention Assemblies. [24:10.10.2.5]

10.10.2.5.1 The backflow prevention assembly shall be forward flow tested to ensure proper operation. [24:10.10.2.5.1]

10.10.2.5.2 The minimum flow rate required by 10.10.2.5.1 shall be the system demand, including hose stream demand where applicable. [24:10.10.2.5.2]

10.10.2.6* The trench shall be backfilled between joints before testing to prevent movement of pipe. [24:10.10.2.6]

10.10.2.7 Where required for safety measures presented by the hazards of open trenches, the pipe and joints shall be permitted to be backfilled, provided the installing contractor takes the responsibility for locating and correcting leakage. [24:10.10.2.7]

10.10.2.8 Provision shall be made for the proper disposal of water used for flushing or testing. [24:10.10.2.8]

Chapter 11 Design Approaches

11.1 General.

The requirements of Section 11.1 shall apply to all sprinkler systems unless modified by a specific section of Chapter 11 or Chapter 12.

11.1.1 A building or portion thereof shall be permitted to be protected in accordance with any applicable design basis at the discretion of the designer.

11.1.2 Adjacent Hazards or Design Methods. For buildings with two or more adjacent hazards or design methods, the following shall apply:

- (1) Where areas are not physically separated by a barrier or partition capable of delaying heat from a fire in one area from fusing sprinklers in the adjacent area, the required sprinkler protection for the more demanding design basis shall extend 15 ft (4.6 m) beyond its perimeter.
- (2) The requirements of 11.1.2(1) shall not apply where the areas are separated by a barrier partition that is capable of preventing heat from a fire in one area from fusing sprinklers in the adjacent area.

11.1.3 For hydraulically calculated systems, the total system water supply requirements for each design basis shall be determined in accordance with the procedures of Section 14.4 unless modified by a section of Chapter 11 or Chapter 12.

11.1.4 Water Demand.

11.1.4.1* The water demand requirements shall be determined from the following:

- (1) Occupancy hazard fire control approach and special design approaches of Chapter 11
- (2) Storage design approaches of Chapter 12 through Chapter 20
- (3) Special occupancy approaches of Chapter 21

11.1.4.2* The minimum water supply requirements for a sprinkler system shall be determined by adding the hose stream allowance to the water supply for sprinklers.

11.1.4.3 The minimum water supply shall be available for the minimum duration specified in Chapter 11.

11.1.5 Hose Allowance.

11.1.5.1 An allowance for inside and outside hose shall not be required where tanks supply sprinklers only.

11.1.5.2 Systems with Multiple Hazard Classifications. For systems with multiple hazard classifications, the hose stream allowance and water supply duration shall be in accordance with one of the following:

- (1) The water supply requirements for the highest hazard classification within the system

- (2) The water supply requirements for each individual hazard classification shall be used in the calculations for the design area for that hazard
- (3)* For systems with multiple hazard classifications where the higher classification only lies within single rooms less than or equal to 400 ft² (37.2 m²) in area with no such rooms adjacent, the water supply requirements for the principal occupancy shall be used for the remainder of the system.

11.1.5.3 Where pumps taking suction from a private fire service main supply sprinklers only, the pump need not be sized to accommodate inside and outside hose. Such hose allowance shall be considered in evaluating the available water supplies.

11.1.5.4 Water allowance for outside hose shall be added to the sprinkler requirement at the connection to the city main or a yard hydrant, whichever is closer to the system riser.

11.1.5.5 Where inside hose stations are planned or are required, the following shall apply:

- (1) A total water allowance of 50 gpm (189 L/min) for a single hose station installation shall be added to the sprinkler requirements.
- (2) A total water allowance of 100 gpm (378 L/min) for a multiple hose station installation shall be added to the sprinkler requirements.
- (3) The water allowance shall be added in 50 gpm (189 L/min) increments beginning at the most remote hose station, with each increment added at the pressure required by the sprinkler system design at that point.

11.1.5.6* When hose valves for fire department use are attached to wet pipe sprinkler system risers in accordance with 8.17.5.2, the following shall apply:

- (1) The water supply shall not be required to be added to standpipe demand as determined from NFPA 14, *Standard for the Installation of Standpipe and Hose Systems*.
- (2) Where the combined sprinkler system demand and hose stream allowance of Table 11.2.3.1.2 exceeds the requirements of NFPA 14, *Standard for the Installation of Standpipe and Hose Systems*, this higher demand shall be used.
- (3) For partially sprinklered buildings, the sprinkler demand, not including hose stream allowance, as indicated in Figure 11.2.3.1.1 shall be added to the requirements given in NFPA 14, *Standard for the Installation of Standpipe and Hose Systems*.

11.2 Occupancy Hazard Fire Control Approach.

11.2.1* General.

11.2.1.1* The water demand requirements shall be determined by either the pipe schedule method in accordance with 11.2.2 or the hydraulic calculation method in accordance with 11.2.3.

11.2.1.2 Occupancy Classifications.

11.2.1.2.1 Occupancy classifications for this standard shall relate to sprinkler installations and their water supplies only.

11.2.1.2.2 Occupancy classifications shall not be used as a general classification of occupancy hazards.

11.2.1.2.3 Occupancies or portions of occupancies shall be classified according to the quantity and combustibility of contents, the expected rates of heat release, the total potential for energy release, the heights of stockpiles, and the presence of flammable and combustible liquids, using the definitions contained in Section 5.2 through Section 5.5. Classifications are as follows:

- (1) Light hazard
- (2) Ordinary hazard (Groups 1 and 2)
- (3) Extra hazard (Groups 1 and 2)
- (4) Special occupancy hazard (*see Chapter 21*)

11.2.2 Water Demand Requirements — Pipe Schedule Method.

11.2.2.1 Table 11.2.2.1 shall be used in determining the minimum water supply requirements for light and ordinary hazard occupancies protected by systems with pipe sized according to the pipe schedules of Section 22.5.

Table 11.2.2.1 Water Supply Requirements for Pipe Schedule Sprinkler Systems

Occupancy Classification	Minimum Residual Pressure Required		Acceptable Flow at Base of Riser (Including Hose Stream Allowance)		Duration (minutes)
	psi	bar	gpm	L/min	
Light hazard	15	1	500–750	1893–2839	30–60
Ordinary hazard	20	1.4	850–1500	3218–5678	60–90

11.2.2.2 Pressure and flow requirements for extra hazard occupancies shall be based on the hydraulic calculation methods of 11.2.3.

11.2.2.3 The pipe schedule method shall be permitted only for new installations of 5000 ft² (465 m²) or less or for additions or modifications to existing pipe schedule systems sized according to the pipe schedules of Section 22.5.

11.2.2.4 Table 11.2.2.1 shall be used in determining the minimum water supply requirements.

11.2.2.5 The pipe schedule method shall be permitted for use in systems exceeding 5000 ft² (465 m²) where the flows required in Table 11.2.2.1 are available at a minimum residual pressure of 50 psi (3.4 bar) at the highest elevation of sprinkler.

11.2.2.6 The pipe schedule method shall be permitted for additions or modifications to existing extra hazard pipe schedule systems.

11.2.2.7 The lower duration value of Table 11.2.2.1 shall be acceptable only where the sprinkler system waterflow alarm device(s) and supervisory device(s) are electrically supervised and such supervision is monitored at an approved, constantly attended location.

11.2.2.8* Residual Pressure.

11.2.2.8.1 The residual pressure requirement of Table 11.2.2.1 shall be met at the elevation of the highest sprinkler.

11.2.2.8.2 When backflow prevention valves are installed on pipe schedule systems, the friction losses of the device shall be accounted for when determining acceptable residual pressure at the top level of sprinklers. The friction loss of this device [in psi (bar)] shall be added to the elevation loss and the residual pressure at the top row of sprinklers to determine the total pressure needed at the water supply.

11.2.2.9 The lower flow figure of Table 11.2.2.1 shall be permitted only where the building is of noncombustible construction or the potential areas of fire are limited by building size or compartmentation such that no open areas exceed 3000 ft² (279 m²) for light hazard or 4000 ft² (372 m²) for ordinary hazard.

11.2.3 Water Demand Requirements — Hydraulic Calculation Methods.

11.2.3.1 General.

11.2.3.1.1 The water supply for sprinklers shall be determined only from one of the following:

- (1) Density/area curves of Figure 11.2.3.1.1 in accordance with the method of 11.2.3.2
- (2) On the basis of the room design method in accordance with 11.2.3.3
- (3) Special design areas in accordance with 11.2.3.4, at the discretion of the designer

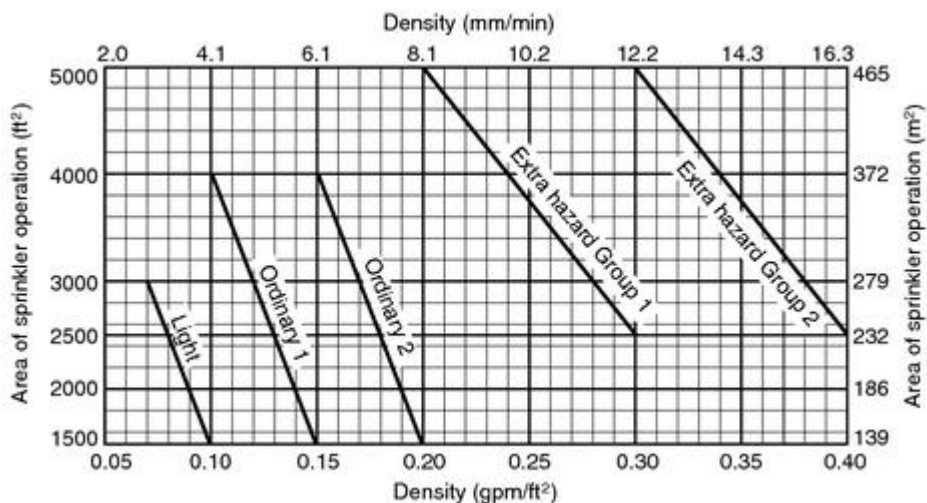

FIGURE 11.2.3.1.1 Density/Area Curves.

11.2.3.1.2 The minimum water supply shall be available for the minimum duration specified

in Table 11.2.3.1.2.

Table 11.2.3.1.2 Hose Stream Allowance and Water Supply Duration Requirements for Hydraulically Calculated Systems

Occupancy	Inside Hose		Total Combined Inside and Outside Hose		Duration (minutes)
	gpm	L/m	gpm	L/m	
Light hazard	0, 50, or 100	0, 189, 379	100	379	30
Ordinary hazard	0, 50, or 100	0, 189, 379	250	946	60–90
Extra hazard	0, 50, or 100	0, 189, 379	500	1893	90–120

11.2.3.1.3 The lower duration values in Table 11.2.3.1.2 shall be permitted where the sprinkler system waterflow alarm device(s) and supervisory device(s) are electrically supervised and such supervision is monitored at an approved, constantly attended location.

11.2.3.1.4 Restrictions. Regardless of which of the two methods (density/area or room design method) is used, the following restrictions shall apply:

- (1) For areas of sprinkler operation less than 1500 ft² (139 m²) used for light and ordinary hazard occupancies, the density for 1500 ft² (139 m²) shall be used.
- (2) For areas of sprinkler operation less than 2500 ft² (232 m²) for extra hazard occupancies, the density for 2500 ft² (232 m²) shall be used.
- (3)* Unless the requirements of 11.2.3.1.4(4) are met for buildings having unsprinklered combustible concealed spaces, as described in 8.15.1.2 and 8.15.6, the minimum area of sprinkler operation for that portion of the building shall be 3000 ft² (279 m²). The design area of 3000 ft² (279 m²) shall be applied only to the sprinkler system or portions of the sprinkler system that are adjacent to the qualifying combustible concealed space.
- (4) The following unsprinklered concealed spaces shall not require a minimum area of sprinkler operation of 3000 ft² (279 m²):
 - (a) Noncombustible and limited-combustible concealed spaces with minimal combustible loading having no access. The space shall be considered a concealed space even with small openings such as those used as return air for a plenum.
 - (b) Noncombustible and limited-combustible concealed spaces with limited access and not permitting occupancy or storage of combustibles. The space shall be considered a concealed space even with small openings such as those used as return air for a plenum.
 - (c) Combustible concealed spaces filled entirely with noncombustible insulation.

- (d)* Light or ordinary hazard occupancies where noncombustible or limited combustibles ceilings are directly attached to the bottom of solid wood joists so as to create enclosed joist spaces 160 ft³ (4.5 m³) or less in volume, including space below insulation that is laid directly on top or within the ceiling joists in an otherwise sprinklered attic.
- (e)* Concealed spaces where rigid materials are used and the exposed surfaces have a flame spread index of 25 or less and the materials have been demonstrated to not propagate fire when tested in accordance with NFPA 255, *Standard Method of Test of Surface Burning Characteristics of Building Materials*, extended for an additional 20 minutes in the form in which they are installed in the space.
- (f) Concealed spaces in which the exposed materials are constructed entirely of fire-retardant treated wood as defined by NFPA 703, *Standard for Fire Retardant-Treated Wood and Fire-Retardant Coatings for Building Materials*.
- (g) Concealed spaces over isolated small rooms not exceeding 55 ft² (5.1 m²) in area.
- (h) Vertical pipe chases under 10 ft² (0.93 m²), provided that in multifloor buildings the chases are firestopped at each floor using materials equivalent to the floor construction and where such pipe chases shall contain no sources of ignition, piping shall be noncombustible, and pipe penetrations at each floor shall be properly sealed.
- (i) Exterior columns under 10 ft² (0.93 m²) in area formed by studs or wood joist, supporting exterior canopies that are fully protected with a sprinkler system.

11.2.3.2 Density/Area Method.

11.2.3.2.1 Water Supply.

11.2.3.2.1.1 The water supply requirement for sprinklers only shall be calculated from the density/area curves of Figure 11.2.3.1.1 or from Chapter 21 where density/area criteria are specified for special occupancy hazards.

11.2.3.2.1.2 When using Figure 11.2.3.1.1, the calculations shall satisfy any single point on the appropriate density/area curve.

11.2.3.2.1.3 When using Figure 11.2.3.1.1, it shall not be necessary to meet all points on the selected curves.

11.2.3.2.2 Sprinklers.

11.2.3.2.2.1 The densities and areas provided in Figure 11.2.3.1.1 shall be for use only with spray sprinklers.

11.2.3.2.2.2 Quick-response sprinklers shall not be permitted for use in extra hazard occupancies or other occupancies where there are substantial amounts of flammable liquids or combustible dusts.

11.2.3.2.2.3 For extended coverage sprinklers, the minimum design area shall be that corresponding to the hazard in Figure 11.2.3.1.1 or the area protected by five sprinklers, whichever is greater.

11.2.3.2.2.4 Extended coverage sprinklers shall be listed with and designed for the minimum flow corresponding to the density for the hazard as specified in Figure 11.2.3.1.1.

11.2.3.2.3 Quick-Response Sprinklers.

11.2.3.2.3.1 Where listed quick-response sprinklers, including extended coverage quick-response sprinklers, are used throughout a system or portion of a system having the same hydraulic design basis, the system area of operation shall be permitted to be reduced without revising the density as indicated in Figure 11.2.3.2.3.1 when all of the following conditions are satisfied:

- (1) Wet pipe system
- (2) Light hazard or ordinary hazard occupancy
- (3) 20 ft (6.1 m) maximum ceiling height
- (4) There are no unprotected ceiling pockets as allowed by 8.6.7 and 8.8.7 exceeding 32 ft² (3 m²)

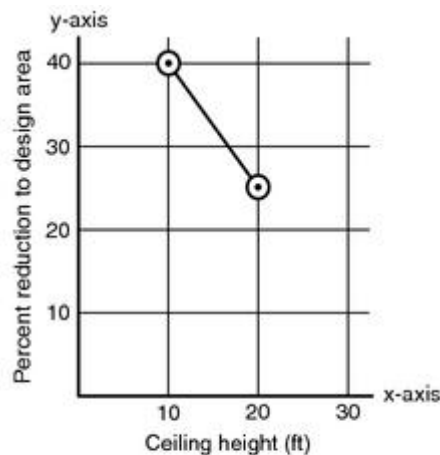

Note: $y = \frac{-3x}{2} + 55$

For ceiling height ≥ 10 ft and ≤ 20 ft, $y = \frac{-3x}{2} + 55$

For ceiling height < 10 ft, $y = 40$

For ceiling height > 20 , $y = 0$

For SI units, 1 ft = 0.31 m.

FIGURE 11.2.3.2.3.1 Design Area Reduction for Quick-Response Sprinklers.

11.2.3.2.3.2 The number of sprinklers in the design area shall never be less than five.

11.2.3.2.3.3 Where quick-response sprinklers are used on a sloped ceiling, the maximum ceiling height shall be used for determining the percent reduction in design area.

11.2.3.2.4 Sloped Ceilings. The system area of operation shall be increased by 30 percent

without revising the density when the following types of sprinklers are used on sloped ceilings with a pitch exceeding 1 in 6 (a rise of 2 units in a run of 12 units, a roof slope of 16.7 percent) in non-storage applications:

- (1) Spray sprinklers, including extended coverage sprinklers listed in accordance with 8.4.3(4), and quick-response sprinklers
- (2) Control mode specific application and large drop sprinklers

11.2.3.2.5* Dry Pipe and Double Interlock Preaction Systems. For dry pipe systems and double interlock preaction systems, the area of sprinkler operation shall be increased by 30 percent without revising the density.

11.2.3.2.6 High-Temperature Sprinklers. Where high-temperature sprinklers are used for extra hazard occupancies, the area of sprinkler operation shall be permitted to be reduced by 25 percent without revising the density, but not to less than 2000 ft² (186 m²).

11.2.3.2.7* Multiple Adjustments.

11.2.3.2.7.1 Where multiple adjustments to the area of operation are required to be made in accordance with 11.2.3.2.3, 11.2.3.2.4, 11.2.3.2.5, or 11.2.3.2.6, these adjustments shall be compounded based on the area of operation originally selected from Figure 11.2.3.1.1.

11.2.3.2.7.2 If the building has unsprinklered combustibles concealed spaces, the rules of 11.2.3.1.4 shall be applied after all other modifications have been made.

11.2.3.3 Room Design Method.

11.2.3.3.1* The water supply requirements for sprinklers only shall be based upon the room that creates the greatest demand.

11.2.3.3.2 The density selected shall be that from Figure 11.2.3.1.1 corresponding to the occupancy hazard classification and room size.

11.2.3.3.3 To utilize the room design method, all rooms shall be enclosed with walls having a fire-resistance rating equal to the water supply duration indicated in Table 11.2.3.1.2.

11.2.3.3.4 If the room is smaller than the area specified in Figure 11.2.3.1.1, the provisions of 11.2.3.1.4(1) and 11.2.3.1.4(2) shall apply.

11.2.3.3.5 Minimum protection of openings shall be as follows:

- (1) Light hazard — Non-rated automatic or self-closing doors.
- (2) Light hazard with no opening protection — Where openings are not protected, calculations shall include the sprinklers in the room plus two sprinklers in the communicating space nearest each such unprotected opening unless the communicating space has only one sprinkler, in which case calculations shall be extended to the operation of that sprinkler. The selection of the room and communicating space sprinklers to be calculated shall be that which produces the greatest hydraulic demand. For light hazard occupancies with unprotected openings in walls, a minimum lintel of depth of 8 in. (203 mm) is required for openings and the opening shall not exceed 8 ft (2.44 m) in width. It shall be permitted to have a single

opening of 36 in. (914 mm) or less without a lintel, provided there are no other openings to adjoining spaces.

- (3) Ordinary and extra hazard — Automatic or self-closing doors with appropriate fire-resistance ratings for the enclosure.

11.2.3.3.6 Where the room design method is used and the area under consideration is a corridor protected by a single row of sprinklers with protected openings in accordance with 11.2.3.3.5, the maximum number of sprinklers that needs to be calculated is five or when extended coverage sprinklers are installed, all sprinklers contained within 75 linear feet (22.9 linear meters) of corridor.

11.2.3.3.7 Where the area under consideration is a corridor protected by a single row of sprinklers with unprotected openings, in a light hazard occupancy, the design area shall include all sprinklers in the corridor to a maximum of five, or when extended coverage sprinklers are installed, all sprinklers within 75 linear feet (22.9 linear meters) of the corridor.



11.2.3.4 Special Design Areas.

11.2.3.4.1 Where the design area consists of a building service chute supplied by a separate riser, the maximum number of sprinklers that needs to be calculated is three each with a minimum discharge of 15 gpm (57 L/min).

11.2.3.4.2* Where an area is to be protected by a single line of sprinklers, the design area shall include all sprinklers on the line up to a maximum of seven.

11.2.3.4.3 Sprinklers in ducts as described in Section 7.10 and 8.15.12 shall be hydraulically designed to provide a discharge pressure of not less than 7 psi (0.5 bar) at each sprinkler with all sprinklers within the duct flowing.

11.3 Special Design Approaches.

11.3.1 Residential Sprinklers.

11.3.1.1* The design area shall be the area that includes the four adjacent sprinklers that produce the greatest hydraulic demand.

11.3.1.2* Unless the requirements of 11.3.1.3 are met, the minimum required discharge from each of the four hydraulically most demanding sprinklers shall be the greater of the following:

- (1) In accordance with minimum flow rates indicated in individual listings
- (2) Calculated based on delivering a minimum of 0.1 gpm/ft² (4.1 mm/min) over the design area in accordance with the provisions of 8.5.2.1 or 8.6.2.1.2

11.3.1.3 For modifications or additions to existing systems equipped with residential sprinklers, the listed discharge criteria less than 0.1 gpm/ft² (4.1 mm/min) shall be permitted to be used.

11.3.1.4 Where areas such as attics, basements, or other types of occupancies are outside of dwelling units but within the same structure, these areas shall be protected as a separate

design basis in accordance with Section 11.1.

11.3.1.5 Hose stream allowance and water supply duration requirements shall be in accordance with those for light hazard occupancies in Table 11.2.3.1.2.

11.3.2 Exposure Protection.

11.3.2.1* Piping shall be hydraulically calculated in accordance with Section 22.4 to furnish a minimum of 7 psi (0.5 bar) at any sprinkler with all sprinklers facing the exposure operating.

11.3.2.2 Where the water supply feeds other fire protection systems, it shall be capable of furnishing total demand for such systems as well as the exposure system demand.

11.3.3 Water Curtains.

11.3.3.1 Sprinklers in a water curtain such as described in 8.15.4 or 8.15.16.2 shall be hydraulically designed to provide a discharge of 3 gpm per lineal foot (37 L/min per lineal meter) of water curtain, with no sprinklers discharging less than 15 gpm (56.8 L/min).

11.3.3.2 For water curtains employing automatic sprinklers, the number of sprinklers calculated in this water curtain shall be the number in the length corresponding to the length parallel to the branch lines in the area determined by 22.4.4.1.1.

11.3.3.3 If a single fire can be expected to operate sprinklers within the water curtain and within the design area of a hydraulically calculated system, the water supply to the water curtain shall be added to the water demand of the hydraulic calculations and shall be balanced to the calculated area demand.

11.3.3.4 Hydraulic design calculations shall include a design area selected to include ceiling sprinklers adjacent to the water curtain.

11.3.3.5 Sprinklers Under a Roof or Ceiling in Combustible Concealed Spaces of Wood Joist or Wood Truss Construction with Members 3 ft (914 mm) or Less on Center and a Slope Having a Pitch of 4 in 12 or Greater.

11.3.3.5.1 Where sprinkler spacing does not exceed 8 ft (2.5 m) measured perpendicular to the slope, the minimum sprinkler discharge pressure shall be 7 psi (0.5 bar).

11.3.3.5.2 Where sprinkler spacing exceeds 8 ft (2.5 m) measured perpendicular to the slope, the minimum sprinkler discharge pressure shall be 20 psi (1.4 bar).

11.3.3.5.3 Hose stream allowance and water supply duration requirements shall be in accordance with those for light hazard occupancies in Table 11.2.3.1.2.

Chapter 12 General Requirements for Storage

12.1 General.

The requirements of Section 12.1 shall apply to all storage arrangements and commodities

other than miscellaneous storage (Chapter 13) and as modified by specific sections in Chapter 14 through Chapter 20.

12.1.1 Roof Vents and Draft Curtains. Sprinkler protection criteria are based on the assumption that roof vents and draft curtains are not being used. *(See Section C.6.)*

12.1.2 Ceiling Slope. The sprinkler system criteria specified in Chapter 12 and Chapters 14 through 20 are intended to apply to buildings with ceiling slopes not exceeding 2 in 12 (16.7 percent) unless modified by a specific section in Chapter 12 and Chapters 14 through 20.

12.1.3 Building and Storage Height.

12.1.3.1 The maximum building height shall be measured to the underside of the roof deck or ceiling.

12.1.3.2 Early suppression fast-response (ESFR) sprinklers shall be used only in buildings equal to, or less than, the height of the building for which they have been listed.

12.1.3.3 The sprinkler system design shall be based on the storage height and clearance to ceiling that routinely or periodically exist in the building and create the greatest water demand. Where storage is placed above doors, the storage height shall be calculated from the base of storage above the door.

12.1.3.4* Ceiling Height.

12.1.3.4.1 For ceiling heights that exceed 30 ft (9.14 m), where the distance between the ceiling height and top of storage exceeds 20 ft (6.1 m), protection shall be provided for the storage height that would result in a 20 ft (6.1 m) distance between the ceiling height and top of storage.

12.1.3.4.2 The requirements of 12.1.3.4 shall not apply to storage arrangements protected in accordance with Chapter 13, Miscellaneous Storage.

12.2* Hose Connections.

12.2.1 Small hose connections [1½ in. (38 mm)] shall be provided where required by the authority having jurisdiction in accordance with 8.17.5 for first-aid fire-fighting and overhaul operations.

12.2.2 Small hose connections shall not be required for the protection of Class I, II, III, and IV commodities stored 12 ft (3.7 m) or less in height.

12.3* Adjacent Hazards or Design Methods.

For buildings with two or more adjacent hazards or design methods, the following shall apply:

- (1) Where areas are not physically separated by a barrier or partition capable of delaying heat from a fire in one area from fusing sprinklers in the adjacent area, the required sprinkler protection for the more demanding design basis shall extend 15 ft (4.6 m) beyond its perimeter.
- (2) The requirements of 12.3(1) shall not apply where the areas are separated by a barrier

partition that is capable of preventing heat from a fire in one area from fusing sprinklers in the adjacent area.

12.4* Wet Pipe Systems.

12.4.1 Sprinkler systems shall be wet pipe systems.

12.4.2* In areas that are subject to freezing or where special conditions exist, dry-pipe systems and preaction systems shall be permitted to protect storage occupancies.

12.4.3 ESFR sprinklers shall only be permitted to be wet pipe systems.

12.5 Dry Pipe and Preaction Systems.

12.5.1 For dry pipe systems and preaction systems, the area of sprinkler operation shall be increased by 30 percent without revising the density.

12.5.2 Densities and areas shall be selected so that the final area of operation after the 30 percent increase is not greater than 6000 ft² (557.4 m²).



12.6* Storage Applications.

12.6.1 For storage applications with densities of 0.20 gpm/ft² (8.2 mm/min) or less, standard response sprinklers with a K-factor of K-5.6 (80) or larger shall be permitted.

12.6.2 For general storage applications, rack storage, rubber tire storage, roll paper storage, and baled cotton storage being protected with upright and pendent spray sprinklers with required densities of greater than 0.20 gpm/ft² to 0.34 gpm/ft² (8.2 mm/min to 13.9 mm/min), standard response sprinklers with a nominal K-factor of K-8.0 (115) or larger shall be used.

12.6.3 For general storage applications, rack storage, rubber tire storage, roll paper storage, and baled cotton storage being protected with upright and pendent spray sprinklers with required densities greater than 0.34 gpm/ft² (13.9 mm/min), standard response spray sprinklers with a K-factor of K-11.2 (161) or larger that are listed for storage applications shall be used.

12.6.4* Unless the requirements of 12.6.5 are met, the requirements of 12.6.2 and 12.6.3 shall not apply to modifications to existing storage application systems, using sprinklers with K-factors of K-8.0 (115) or less.

12.6.5 Where applying the requirements of Figure 17.2.1.2(b) and Figure 17.2.1.2(c) utilizing the design criteria of 0.6 gpm/ft² per 2000 ft² (24.4 mm/min per 186 m²) to existing storage applications, the requirements of 12.6.3 shall apply.

12.6.6 The use of quick-response spray sprinklers for storage applications shall be permitted when listed for such use.

12.6.7 Large drop, control mode specific application and ESFR sprinklers shall be permitted to protect ordinary hazard, storage of Class I through Class IV commodities, plastic commodities, miscellaneous storage, and other storage as specified in Chapter 12 through

Chapter 20 or by other NFPA standards.

12.6.8 The design figures indicate water demands for ordinary-temperature-rated and nominal high-temperature-rated sprinklers at the ceiling. The ordinary-temperature design densities correspond to ordinary-temperature-rated sprinklers and shall be used for sprinklers with ordinary- and intermediate-temperature classification. The high-temperature design densities correspond to high-temperature-rated sprinklers and shall be used for sprinklers having a high temperature rating.

12.6.9 Ordinary- and intermediate-temperature sprinklers with K-factors of K-11.2 (161) or larger, where listed for storage, shall be permitted to use the densities for high-temperature sprinklers.

12.7 Discharge Considerations.

12.7.1 The water supply for sprinklers only shall be determined either from the density/area requirements of Chapter 12 through Chapter 20 or shall be based upon the room design method in accordance with Section 12.10, at the discretion of the designer.

12.7.2* Systems with Multiple Hazard Classifications. For systems with multiple hazard classifications, the hose stream allowance and water supply duration shall be in accordance with one of the following:

- (1) The water supply requirements for the highest hazard classification within the system.
- (2) The water supply requirements for each individual hazard classification shall be used in the calculations for the design area for that hazard.
- (3)* For systems with multiple hazard classifications where the higher classification only lies within single rooms less than or equal to 400 ft² (37.2 m²) in area with no such rooms adjacent, the water supply requirements for the principal occupancy shall be used for the remainder of the system.

12.7.3 The calculations shall satisfy any single point on appropriate density/area curves.

12.7.4 The minimum water supply requirements shall be determined by adding the hose stream allowance from Chapter 12 through Chapter 20 to the water supply for sprinklers as determined by Chapter 12 through Chapter 20.

12.7.5 The minimum water supply shall be available for the minimum duration specified in Chapter 12 through Chapter 20.

12.7.6 Total system water supply requirements shall be determined in accordance with the hydraulic calculation procedures of Chapter 22.

12.7.7 Multiple Adjustments.

12.7.7.1 Where multiple adjustments to the area of operation are required to be made, these adjustments shall be compounded based on the area of operation originally selected.

12.7.7.2 If the building has unsprinklered combustible concealed spaces, the rules of Section 12.9 shall be applied after all other modifications have been made.

12.8 Hose Demand.

12.8.1 An allowance for inside and outside hose shall not be required where tanks supply sprinklers only.

12.8.2 Where pumps taking suction from a private fire service main supply sprinklers only, the pump need not be sized to accommodate inside and outside hose. Such hose allowance shall be considered in evaluating the available water supplies.

12.8.3 Water allowance for outside hose shall be added to the sprinkler requirement at the connection to the city main or a yard hydrant, whichever is closer to the system riser.

12.8.4 Where inside hose stations are planned or are required, the following shall apply:

- (1) A total water allowance of 50 gpm (189 L/min) for a single hose station installation shall be added to the sprinkler requirements.
- (2) A total water allowance of 100 gpm (378 L/min) for a multiple hose station installation shall be added to the sprinkler requirements.
- (3) The water allowance shall be added in 50 gpm (189 L/min) increments beginning at the most remote hose station, with each increment added at the pressure required by the sprinkler system design at that point.

12.8.5 When hose valves for fire department use are attached to wet pipe sprinkler system risers in accordance with 8.17.5.2, the following shall apply:

- (1) The water supply shall not be required to be added to standpipe demand as determined from NFPA 14, *Standard for the Installation of Standpipe and Hose Systems*.
- (2) Where the combined sprinkler system demand and hose stream allowance of Chapter 12 and Chapters 14 through 20 exceeds the requirements of NFPA 14, *Standard for the Installation of Standpipe and Hose Systems*, this higher demand shall be used.
- (3) For partially sprinklered buildings, the sprinkler demand, not including hose stream allowance, as indicated in Chapter 12 and Chapters 14 through 20 shall be added to the requirements given in NFPA 14, *Standard for the Installation of Standpipe and Hose Systems*.

12.9 Restrictions.

12.9.1 Unless the requirements of 12.9.2 are met for buildings having unsprinklered combustible concealed spaces as described in 8.15.1.2 and 8.15.6, the minimum area of operation shall be 3000 ft² (279 m²). The design area of 3000 ft² (279 m²) shall be applied only to the sprinkler system or portions of the sprinkler system that are adjacent to the qualifying combustible concealed space.

12.9.2 The following unsprinklered combustible concealed spaces shall not require a minimum design area of sprinkler operation of 3000 ft² (279 m²):

- (1) Noncombustible and limited-combustible concealed spaces with minimal combustible

loading having no access. The space shall be considered a concealed space even with small openings such as those used as return air for a plenum.

- (2) Noncombustible and limited-combustible concealed spaces with limited access and not permitting occupancy or storage of combustibles. The space shall be considered a concealed space even with small openings such as those used as return air for a plenum.
- (3) Combustible concealed spaces filled entirely with noncombustible insulation.
- (4)* Light or ordinary hazard occupancies where noncombustible or limited-combustible ceilings are directly attached to the bottom of solid wood joists so as to create enclosed joist spaces 160 ft³ (4.5 m³) or less in volume, including space below insulation that is laid directly on top or within the ceiling joists in an otherwise sprinklered attic.
- (5)* Concealed spaces where rigid materials are used and the exposed surfaces have a flame spread index of 25 or less and the materials have been demonstrated to not propagate fire when tested in accordance with NFPA 255, *Standard Method of Test of Surface Burning Characteristics of Building Materials*, extended for an additional 20 minutes in the form in which they are installed in the space.
- (6) Concealed spaces in which the exposed materials are constructed entirely of fire-retardant treated wood as defined by NFPA 703, *Standard for Fire Retardant-Treated Wood and Fire-Retardant Coatings for Building Materials*.
- (7) Concealed spaces over isolated small rooms not exceeding 55 ft² (5.1 m²) in area.
- (8) Vertical pipe chases under 10 ft² (0.93 m²), provided that in multifloor buildings the chases are firestopped at each floor using materials equivalent to the floor construction. Such pipe chases shall contain no sources of ignition, piping shall be noncombustible, and pipe penetrations at each floor shall be properly sealed.
- (9) Exterior columns under 10 ft² (0.93 m²) in area formed by studs or wood joist, supporting exterior canopies that are fully protected with a sprinkler system.

12.10 Room Design Method.

12.10.1* The water supply requirements for sprinklers only shall be based upon the room that creates the greatest demand.

12.10.2 To utilize the room design method, all rooms shall be enclosed with walls having a fire-resistance rating equal to the water supply duration indicated in Chapters 13 through 20.

12.10.3 Where the room design method is used, the density shall correspond to that required for the smallest area acceptable under the density/area method.

12.11* High-Expansion Foam Systems.

12.11.1 High-expansion foam systems that are installed in addition to automatic sprinklers

shall be installed in accordance with NFPA 11, *Standard for Low-, Medium-, and High-Expansion Foam*.

12.11.2 High-expansion foam systems shall be automatic in operation.

12.11.3 High-expansion foam used to protect the idle pallet shall have a maximum fill time of 4 minutes.

12.11.4 Detectors for high-expansion foam systems shall be listed and shall be installed at no more than one-half the listed spacing.

12.11.5 The release system for the high expansion foam deluge system shall be designed to operate prior to the sprinklers installed in the area.

12.12* Protection of Idle Pallets.

12.12.1 Wood Pallets.

12.12.1.1* Wood pallets shall be permitted to be stored in the following arrangements:

- (1) Stored outside
- (2) Stored in a detached structure
- (3) Stored indoors where arranged and protected in accordance with 12.12.1.2

12.12.1.2* Wood pallets, where stored indoors, shall be protected in accordance with one of the following:

- (1) Control mode density-area sprinkler protection as specified in Table 12.12.1.2(a).
- (2) Large drop sprinkler protection in accordance with Table 12.12.1.2(b).
- (3) Control mode specific application sprinkler protection in accordance with Table 12.12.1.2(c).
- (4) ESFR sprinkler protection in accordance with Table 12.12.1.2(d).
- (5) Control mode density-area sprinkler protection in accordance with the OH2 curve of Figure 13.2.1 existing with a hose stream demand of at least 250 gpm (946 L/min) for a duration of at least 60 minutes when pallets are stored no higher than 6 ft (1.8 m) and each pile of no more than four stacks shall be separated from other pallet piles by at least 8 ft (1.4 m) of clear space or 25 ft (7.6 m) of commodity. The maximum clearance of 20 ft (6.1 m) specified in 12.1.3.4 shall not apply to arrangement 12.12.1.2(5).

Table 12.12.1.2(a) Control Mode Density-Area Sprinkler Protection for In

			Maximum Storage Height	Maximum Ceiling/Roof Height ¹	Sprinkler Density	Te
--	--	--	------------------------	--	-------------------	----

by at least 8 ft (1.4 m) of clear space or 25 ft (7.6 m) of commodity. The maximum clearance of 20 ft (6.1 m) specified in 12.1.3.4 shall not apply to arrangement 12.12.1.2(5).

Table 12.12.1.2(a) Control Mode Density-Area Sprinkler Protection for In

Type of Sprinkler	Location of Storage	Nominal K-Factor	Maximum Storage Height		Maximum Ceiling/Roof Height ¹		Sprinkler Density		Te
			ft	m	ft	m	gpm/ft ²	mm/min	
Control mode density/area	On floor	8 (115) or larger	Up to 6	Up to 1.8	20	6.1	0.20	8.2	20'
	On floor	11.2 (161) or larger	Up to 8	Up to 2.4	30	9.1	0.45	18.3	25'
	On floor or rack without solid shelves	11.2 (161) or larger	8 to 12	2.4 to 3.7	30	9.1	0.6	24.5	35'
			12 to 20	3.7 to 6.1	30	9.1	0.6	24.5	45'
	On floor	16.8 (242) or larger	Up to 20	Up to 6.1	30	9.1	0.6	24.5	—

Note: For ceiling heights that exceed 30 ft (9.1 m), the requirements of 12.1.3.4 shall be applied.

Table 12.12.1.2(b) Large Drop Protection for Indoor Storage

Type of Sprinkler	Location of Storage	Nominal K-Factor	Maximum Storage Height		Maximum Ceiling/Roof Height		Type of System	Number of Design Sprinkler Pressure	
			ft	m	ft	m		25 psi (1.7 bar)	50 psi (3.4 bar)
Large drop	On floor	11.2 (161)	20	6.1	30	9.1	Wet	15	15
							Dry	25	25

Table 12.12.1.2(c) Specific Application Control Mode (16.8 K-Factor) Sprinkler Protection

			Maximum Storage Height	Maximum Ceiling/Roof Height			Minimum
--	--	--	------------------------	-----------------------------	--	--	---------

- (1) Plastic pallets shall be permitted to be stored outside.
- (2) Plastic pallets shall be permitted to be stored in a detached structure.
- (3) Plastic pallets shall be permitted to be stored indoors where arranged and protected in accordance with the requirements of 12.12.2.2.
- (4) Indoor storage of plastic pallets shall be permitted to be protected in accordance with the requirements of Table 12.12.2.1
- (5) Indoor storage of plastic pallets shall be permitted to be protected in accordance with the following arrangement:
 - (a) Maximum storage height of 10 ft (3.05 m)
 - (b) Maximum ceiling height of 30 ft (9.1 m)
 - (c) Sprinkler density 0.6 gpm/ft² (24.4 mm/min) over 2000 ft² (186 m²)
 - (d) Minimum sprinkler K-factor of 16.8
- (6) Indoor storage of non-wood pallets having a demonstrated fire hazard that is equal to or less than idle wood pallets and is listed for such equivalency shall be permitted to be protected in accordance with 12.12.1.
- (7) When specific test data are available, the data shall take precedence in determining the required protection of idle plastic pallets.

Table 12.12.2.1 ESFR Protection of Indoor Storage of Idle Plastic Pallets

Type of Sprinkler (Orientation)	Location of Storage	Nominal K-Factor	Maximum Storage Height		Maximum Ceiling/Roof Height		M
			ft	m	ft	m	
ESFR (pendent)	On floor or rack without solid shelves	14.0 (201)	25	7.6	30	9.1	
			25	7.6	32	9.8	
			35	10.7	40	12.2	
		16.8 (242)	25	7.6	30	9.1	
			25	7.6	32	9.8	
			35	10.7	40	12.2	

12.12.2.2 Plastic pallets where stored indoors shall be protected as follows:

- (1) Where stored in cutoff rooms, the following shall apply:
 - (a) The cutoff rooms shall have at least one exterior wall.
 - (b) The plastic pallet storage shall be separated from the remainder of the building by 3 hour-rated fire walls.

- (c) Sprinkler protection by one of the following:
 - i. The storage shall be protected by sprinklers designed to deliver 0.6 gpm/ft² (24.5 mm/min) for the entire room or by high-expansion foam and sprinklers designed to deliver 0.30 gpm/ft² (12.2 mm/min) for the entire room.
 - ii. K-14 ESFR upright sprinklers when the storage is on floor and the system is designed to supply all sprinklers in the room at 50 psi (3.4 bar) for a maximum of 30 ft (9.1 m) ceiling or 75 psi (5.2 bar) for a maximum 35 ft (10.7 m) ceiling.
 - (d) The storage shall be piled no higher than 12 ft (3.7 m).
 - (e) Any steel columns shall be protected by 1 hour fireproofing or a sidewall sprinkler directed to one side of the column at the top or at the 15 ft (4.6 m) level, whichever is lower. Flow from these sprinklers shall be permitted to be omitted from the sprinkler system demand for hydraulic calculations.
- (2) Where stored without cutoffs from other storage, the following shall apply:
- (a) Plastic pallet storage shall be piled no higher than 4 ft (1.2 m).
 - (b) Sprinkler protection shall employ high temperature-rated sprinklers.
 - (c) Each pallet pile of no more than two stacks shall be separated from other pallet piles by at least 8 ft (2.4 m) of clear space or 25 ft (7.6 m) of stored commodity.

12.12.2.3 Idle plastic pallets shall be stored only in racks where protected in accordance with the requirements of Table 12.12.2.1. When specific test data and a product listing are available, the data shall take precedence in determining the required protection of idle plastic pallets stored in racks.

12.12.3 Idle Pallets Stored on Racks, on Shelves, and Above Doors.

12.12.3.1 Idle pallets shall not be stored on racks or shelves, except where permitted in 12.12.1.3, 12.12.2.3, and 12.12.3.2.

12.12.3.2 Idle wood pallets shall be permitted to be stored on the lowest level of storage only where no storage or shelves are located above the stored pallets and the applicable protection criteria referenced in Section 12.12 are applied.

12.12.3.3 Where idle pallet storage is above a door, the idle pallet storage height shall be calculated from the base of storage above the door using the applicable protection criteria referenced in Section 12.12.

Chapter 13 Miscellaneous Storage

13.1 Miscellaneous Storage up to 12 ft (3.7 m) in Height.

13.1.1 Hose Connections. Hose connections shall not be required for the protection of

miscellaneous storage.

13.2 Design Basis.

13.2.1 For protection of miscellaneous storage up to 12 ft (3.7 m) in height of Class I through Class IV commodities, Group A plastic, rubber tires, and rolled paper, the discharge criteria in Table 13.2.1 and Figure 13.2.1 shall apply.

Table 13.2.1 Discharge Criteria for Miscellaneous Storage 12 ft (3.7

Commodity	Type of Storage	Storage Height		Maximum Ceiling Height		Design Curve Figure 13.2.1	Notes	
		ft	m	ft	m			
Class I to IV								
Class I	Palletized, bin box, shelf, and rack	≤ 12	≤ 3.7	—	—	OH1		
Class II		≤ 10	≤ 3.05	—	—	OH1		
Class II		>10 to ≤ 12	>3.05 to ≤ 3.7	—	—	OH2		
Class III		≤ 12	≤ 3.7	—	—	OH2		
Class IV		≤ 10	≤ 3.05	—	—	OH2		
Class IV	Palletized, bin box, and shelf	>10 to ≤ 12	>3.05 to ≤ 3.7	32	—	OH2		
Class IV	Rack	>10 to ≤ 12	>3.05 to ≤ 3.7	32	—	EH1		
Group A Plastic Storage								
Cartoned	Unexpanded and expanded	Palletized, bin box, shelf, and rack	≤ 5	≤ 1.5	—	—	OH2	
			>5 to ≤ 10	>1.5 to ≤ 3.05	15	4.6	EH1	
			>5 to ≤ 10	>1.5 to ≤ 3.05	20	6.1	EH2	
			>10 to ≤ 12	>3.05 to ≤ 3.7	17	5.2	EH2	
			>10 to ≤ 12	>3.05 to ≤ 3.7	32	5.2	OH2	+ level in-ra
		Palletized, bin box, and shelf	>10 to ≤ 12	>3.05 to ≤ 3.7	32	8.2	EH2	
		Rack	>10 to ≤ 12	>3.05 to ≤ 3.7	32	—	OH2	+ level in-ra

Table 13.2.1 Discharge Criteria for Miscellaneous Storage 12 ft (3.7

Commodity	Type of Storage	Storage Height		Maximum Ceiling Height		Design Curve Figure 13.2.1	Notes	
		ft	m	ft	m			
Exposed	Unexpanded and expanded	Palletized, bin box, shelf, and rack	≤ 5	≤ 1.5	—	—	OH2	
		Palletized, bin box, and shelf	>5 to ≤ 8	>1.5 to ≤ 2.4	28	—	EH2	
		Palletized, bin box, shelf, and rack	>5 to ≤ 10	>1.5 to ≤ 3.05	15	4.6	EH2	
	Unexpanded	Palletized, bin box, shelf, and rack	>5 to ≤ 10	>1.5 to ≤ 3.05	20	6.1	EH2	
	Expanded	Rack	>5 to ≤ 10	>1.5 to ≤ 3.05	20	6.1	OH2	+ level in-ra
	Unexpanded and expanded	Palletized, bin box, and shelf	>10 to ≤ 12	>3.05 to ≤ 3.7	17	5.2	EH2	
		Rack	>10 to ≤ 12	>3.05 to ≤ 3.7	17	5.2	EH2	
			>10 to ≤ 12	>3.05 to ≤ 3.7	32	—	OH2	+ level in-ra
	Tire Storage							
	Tires	On floor, on side	>5 to ≤ 12	>1.5 to ≤ 3.7	32	—	EH1	
On floor, on tread or on side		≤ 5	≤ 1.5	—	—	OH2		
Single-, double-, or multiple-row racks on tread or on side		≤ 5	≤ 1.5	—	—	OH2		
Single-row rack, portable, on tread or on side		>5 to ≤ 12	>1.5 to ≤ 3.7	32	—	EH1		
Single-row rack, fixed, on tread or on side		>5 to ≤ 12	>1.5 to ≤ 3.7	32	—	EH1		
		>5 to ≤ 12	>1.5 to ≤ 3.7	32	—	2	+ level in-ra	
Rolled Paper Storage								
Heavy and medium weight	On end	≤ 10	≤ 3.05	30	—	OH2		

Table 13.2.1 Discharge Criteria for Miscellaneous Storage 12 ft (3.7

Commodity	Type of Storage	Storage Height		Maximum Ceiling Height		Design Curve Figure 13.2.1	No.
		ft	m	ft	m		
Tissue and light weight	On end	≤ 10	≤ 3.05	30	—	EH1	

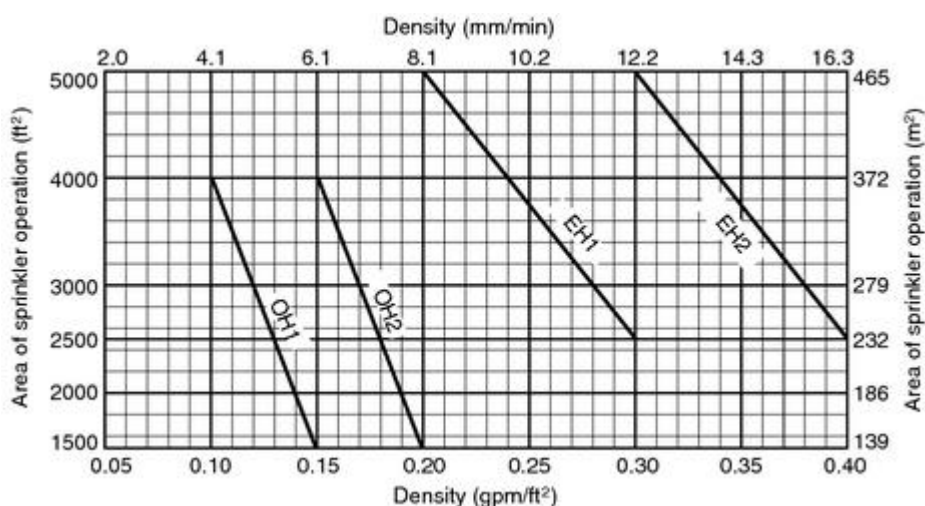

FIGURE 13.2.1 Miscellaneous Storage 12 ft (3.7 m) or Less in Height — Design Curves (see Table 13.2.1).

13.2.2 Design criteria and modifiers as permitted by the density/area method of Chapter 11 for Ordinary Hazard Group 1, Ordinary Hazard Group 2, Extra Hazard Group 1, and Extra Hazard Group 2 Occupancies shall be applicable for the protection of miscellaneous storage and commodity Class I through Class IV storage 12 ft (3.7 m) or less in height as required by Table 13.2.1 and Figure 13.2.1.

13.3 In-Rack Sprinklers.

13.3.1 General. In-rack sprinklers required by Table 13.2.1 shall meet the requirements of this section and the applicable storage protection and arrangement sections of this chapter.

13.3.2 Discharge Criteria. In-rack sprinklers shall have a K-factor of 5.6 or larger and operate at a minimum of 15 psi (1 bar).

13.3.3 Water Demand. Where one level of in-rack sprinklers is installed for miscellaneous storage, water demand shall be based on simultaneous operation of the hydraulically most demanding four adjacent sprinklers.

Chapter 14 Protection of Class I to Class IV Commodities That

Are Stored Palletized, Solid Piled, Bin Boxes, or Shelf Storage

14.1 General.

This chapter shall apply to a broad range of combustibles that are stored palletized, solid piled, bin boxes, or shelf storage. The requirements of Chapter 12 shall apply unless modified by this chapter.

14.1.1* The minimum water supply requirements for a hydraulically designed occupancy hazard fire control sprinkler system shall be determined by adding the hose stream allowance from Table 14.1.1 to the water supply for sprinklers. This supply shall be available for the minimum duration specified in Table 14.1.1. *(See Section C.8.)*

Table 14.1.1 Hose Stream Allowance and Water Supply Duration Req

Commodity Classification	Storage Height		Inside Hose		Tot
	ft	m	gpm	L/min	;
Class I, II, and III	Over 12 up to 20	Over 3.7 up to 6.1	0, 50, or 100	0, 190, 380	
	Over 20 up to 30	Over 6.1 up to 9.1	0, 50, or 100	0, 190, 380	
Class IV	Over 12 up to 20	Over 3.7 up to 6.1	0, 50, or 100	0, 190, 380	
	Over 20 up to 30	Over 6.1 up to 9.1	0, 50, or 100	0, 190, 380	

14.2* Control Mode Density–Area Sprinkler Protection Criteria for Palletized, Solid Piled, Bin Box, or Shelf Storage of Class I Through Class IV Commodities.

14.2.1 Protection for Class I through Class IV commodities in the following configurations shall be provided in accordance with this chapter:

- (1) Nonencapsulated commodities that are solid pile, palletized, or bin box storage up to 30 ft (9.1 m) in height
- (2) Nonencapsulated commodities on shelf storage up to 15 ft (4.6 m) in height
- (3)* Encapsulated commodities that are solid pile, palletized, bin box, or shelf storage up to 15 ft (4.6 m) in height

14.2.2 The area and density for the hydraulically remote area and the water supply shall be determined as specified in 14.2.3 for storage up to and including 12 ft (3.7 m) and 14.2.4 for storage over 12 ft (3.7 m).

14.2.3 Protection Criteria for Palletized, Solid Piled, Bin Box, or Shelf Storage of Class I Through Class IV Commodities Stored up to 12 ft (3.7 m) in Height.

14.2.3.1 The protection criteria for storage up to and including 12 ft (3.7 m) shall be the same as for miscellaneous storage selected from Chapter 13. The protection criteria in Chapter 13 shall be acceptable for storage of Class I to IV commodities up to and including 12 ft (3.7 m) in height. See Table 13.2.1, Discharge Criteria for Miscellaneous Storage 12 ft

(3.7 m) or less in Height for specific Class I to IV storage height protection criteria.

14.2.4 Protection Criteria for Palletized, Solid-Piled, Bin Box, or Shelf Storage of Class I Through Class IV Commodities Stored over 12 ft (3.7 m) in Height.

14.2.4.1 Where using ordinary temperature-rated sprinklers, a single point shall be selected from the appropriate commodity curve on Figure 14.2.4.1.

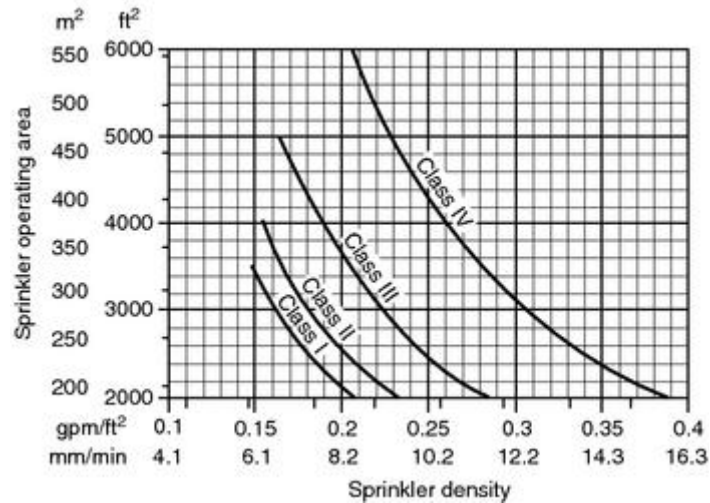

FIGURE 14.2.4.1 Sprinkler System Design Curves, 20 ft (6.1 m) High Storage — Ordinary Temperature-Rated Sprinklers.

14.2.4.2 Where using high temperature-rated sprinklers, a single point shall be selected from the appropriate commodity curve on Figure 14.2.4.2.

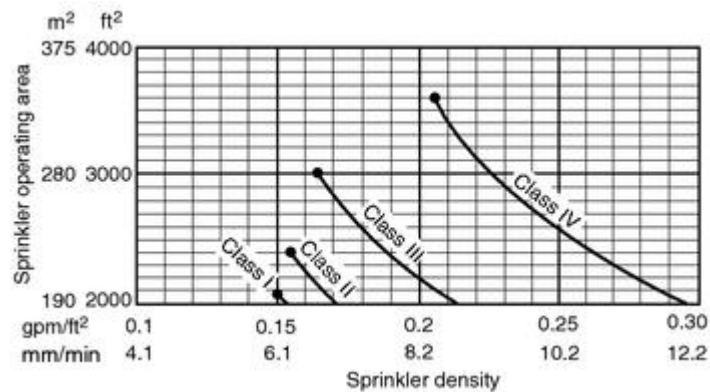

FIGURE 14.2.4.2 Sprinkler System Design Curves, 20 ft (6.1 m) High Storage — High Temperature-Rated Sprinklers.

14.2.4.3 The densities selected in accordance with 14.2.4.1 or 14.2.4.2 shall be modified in accordance with Figure 14.2.4.3 without revising the design area.

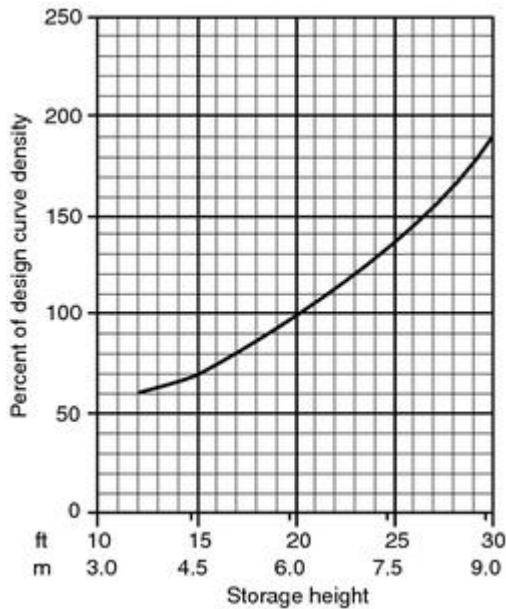

FIGURE 14.2.4.3 Ceiling Sprinkler Density vs. Storage Height.

14.2.4.4 In the case of metal bin boxes with face areas not exceeding 16 ft² (1.5 m²) and metal closed shelves with face areas not exceeding 16 ft² (1.5 m²), the area of application shall be permitted to be reduced by 50 percent, provided the minimum requirements of 14.2.4.5 and 14.2.4.6 are met.

14.2.4.5 For storage greater than 12 ft (3.7 m), the design density shall not be less than 0.15 gpm/ft² (6.1 mm/min), and the design area shall not be less than 2000 ft² (186 m²) for wet systems or 2600 ft² (242 m²) for dry systems for any commodity, class, or group.

14.2.4.6 For storage greater than 12 ft (3.7 m), the sprinkler design density for any given area of operation for a Class III or Class IV commodity, calculated in accordance with 14.2.4, shall not be less than the density for the corresponding area of operation for Ordinary Hazard Group 2.

14.3 Large Drop Sprinklers and Specific Application Control Mode Sprinklers for Palletized or Solid-Piled Storage of Class I Through Class IV Commodities.

14.3.1 Protection of palletized and solid-piled storage of Class I through Class IV commodities shall be in accordance with Table 14.3.1(a) and Table 14.3.1(b).

Table 14.3.1(a) Large Drop Sprinkler Design Criteria for Palletized and Solid-Pile Commodities

Storage Arrangement	Commodity Class	Nominal K-Factor	Maximum Storage Height		Maximum Ceiling/ Roof Height		Type of System	Numl Sprinkl
			ft	m	ft	m]
								/psi

Table 14.3.1(a) Large Drop Sprinkler Design Criteria for Palletized and Solid-Pile Commodities

Storage Arrangement	Commodity Class	Nominal K-Factor	Maximum Storage Height		Maximum Ceiling/ Roof Height		Type of System	Number of Sprinklers
			ft	m	ft	m		/psi
Palletized	I, II, III	11.2 (161)	25	7.6	35	10.7	Wet	15/2:
							Dry	25/2:
	IV	11.2 (161)	20	6.1	30	9.1	Wet	20/2:
							Dry	N/A
	IV	11.2 (161)	20	6.1	30	9.1	Wet	15/50
							Dry	N/A
Solid-Piled	I, II, III	11.2 (161)	20	6.1	30	9.1	Wet	15/2:
							Dry	25/2:
	IV	11.2 (161)	20	6.1	30	9.1	Wet	15/50
							Dry	N/A

Table 14.3.1(b) Specific Application Control Mode [16.8 K-Factor (242)] Sprinkler Design Criteria for Storage of Class I Through Class IV Commodities

Configuration	Commodity Class	Maximum Storage Height		Maximum Building Height		Type of System	Number of Design Sprinklers by Minimum Operating Pressure	
		ft	m	ft	m		10 psi (0.7 bar)	15 psi (1.0 bar)
Palletized	I or II	25	7.6	30	9.1	Wet	15	25
Palletized	III or IV	25	7.6	30	9.1	Wet	—	—
Solid-piled	I or II	25	7.6	30	9.1	Wet	15	25
Solid-piled	III or IV	25	7.6	30	9.1	Wet	—	—

14.3.2 Protection shall be provided as specified in Table 14.3.1(a) and Table 14.3.1(b), or appropriate NFPA standards in terms of minimum operating pressure and the number of sprinklers to be included in the design area.

14.3.3 The minimum number of design sprinklers for ordinary hazard and miscellaneous storage in accordance with this standard shall be 15 for wet pipe systems and 25 for preaction systems and dry pipe systems.

14.3.4 Open Wood Joist Construction.

14.3.4.1 Where large drop K-11.2 (161) sprinklers are installed under open wood joist construction, their minimum operating pressure shall be 50 psi (3.4 bar).

14.3.4.2 For large drop sprinklers, where each joist channel of open, wood joist construction is fully fire-stopped to its full depth at intervals not exceeding 20 ft (6.1 m), the lower pressures specified in Table 14.3.1(a) shall be permitted to be used.

14.3.5 For large drop sprinklers, the design area shall be a rectangular area having a dimension parallel to the branch lines at least 1.2 times the square root of the area protected by the number of sprinklers to be included in the design area. Any fractional sprinkler shall be included in the design area.

14.3.6 Hose stream allowance and water supply duration requirements shall be in accordance with Table 14.3.1(a) and Table 14.3.1(b).

14.3.7 Preaction Systems.

14.3.7.1 For the purpose of using Table 14.3.1(a) and Table 14.3.1(b), preaction systems shall be classified as dry pipe systems.

14.3.8 Building steel shall not require special protection where Table 14.3.1(a) and Table 14.3.1(b) are applied as appropriate for the storage configuration.

14.4 Early Suppression Fast-Response (ESFR) Sprinklers for Palletized or Solid Piled Storage of Class I Through Class IV Commodities.

14.4.1 Protection of palletized and solid-piled storage of Class I through Class IV commodities shall be in accordance with Table 14.4.1.

Table 14.4.1 ESFR Protection of Palletized and Solid-Piled Storage of Class I Through

Commodity	Maximum Storage Height		Maximum Ceiling/Roof Height		Nominal K-Factor	Orientation	Minimum Operating Pressure	
	ft	m	ft	m			psi	bar

Table 14.4.1 ESFR Protection of Palletized and Solid-Piled Storage of Class I Through

Commodity	Maximum Storage Height		Maximum Ceiling/Roof Height		Nominal K-Factor	Orientation	Minimum Operating Pressure	
	ft	m	ft	m			psi	bar
	20	6.1	25	7.6	14.0 (201)	Upright or pendent	50	3.4
					16.8 (242)	Upright/Pendent	35	2.4
					22.4 (322)	Pendent	25	1.7
					25.2 (363)	Pendent	15	1.0
	25	7.6	30	9.1	14.0 (201)	Upright or pendent	50	3.4
					16.8 (242)	Upright/Pendent	35	2.4
					22.4 (322)	Pendent	25	1.7
					25.2 (363)	Pendent	15	1.0
				14.0 (201)	Upright or nendent	60	4.1	

Table 14.4.1 ESFR Protection of Palletized and Solid-Piled Storage of Class I Through

Commodity	Maximum Storage Height		Maximum Ceiling/Roof Height		Nominal K-Factor	Orientation	Minimum Operating Pressure	
	ft	m	ft	m			psi	bar
Class I, II, III, or IV, encapsulated (no open-top containers or solid shelves)			32	9.8	16.8 (242)	Pendent	42	2.9
	30	9.1	35	10.7	14.0 (201)	Upright or pendent	75	5.2
					16.8 (242)	Upright/Pendent	52	3.6
					22.4 (322)	Pendent	35	2.4
					25.2 (363)	Pendent	20	1.4
	35	10.7	40	12.2	14.0 (201)	Pendent	75	5.2
					16.8 (242)	Upright/Pendent	52	3.6
					22.4 (322)	Pendent	40	2.8
					25.2 (363)	Pendent	25	1.7
	35	10.7	45	13.7	22.4 (322)	Pendent	40	2.8
					25.2 (363)	Pendent	40	2.8
	40	12.2	45	13.7	22.4 (322)	Pendent	40	2.8
					25.2 (363)	Pendent	40	2.8

14.4.2 ESFR sprinkler systems shall be designed such that the minimum operating pressure is not less than that indicated in Table 14.4.1 for commodity, storage height, and building height involved.

14.4.3 The design area shall consist of the most hydraulically demanding area of 12 sprinklers, consisting of four sprinklers on each of three branch lines.

14.4.4 Where ESFR sprinklers are installed above and below obstructions, the discharge for up to two sprinklers for one of the levels shall be included with those of the other level in the hydraulic calculations.

14.5 Special Design for Palletized, Solid Piled, Bin Box, or Shelf Storage of Class I

Through Class IV Commodities.

Bin box and shelf storage that is over 12 ft (3.7 m) but not in excess of the height limits of 14.2.1 and that is provided with walkways at vertical intervals of not over 12 ft (3.7 m) shall be protected with automatic sprinklers under the walkway(s). Protection shall be as follows:

- (1) Ceiling design density shall be based on the total height of storage within the building.
- (2) Automatic sprinklers under walkways shall be designed to maintain a minimum discharge 15 psi (1 bar) for the most hydraulically demanding six sprinklers on each level. Walkway demand shall not be required to be added to the ceiling sprinkler demand. Sprinklers under shall not be spaced more than 8 ft (2.4 m) apart horizontally.

14.6 High Expansion Foam — Reduction to Ceiling Density.

A reduction in ceiling density to one-half that required for Class I through Class IV commodities, idle pallets, or plastics shall be permitted without revising the design area, but the density shall be no less than 0.15 gpm/ft² (6.1 mm/min).

Chapter 15 Protection of Plastic and Rubber Commodities That Are Stored Palletized, Solid Piled, Bin Boxes, or Shelf Storage

15.1 General.

This chapter shall apply to plastic and rubber commodities that are stored palletized, solid pile, bin boxes, or shelf storage. The requirements of Chapter 12 shall apply unless modified by this chapter.

15.1.1 The minimum water supply requirements for a hydraulically designed occupancy hazard fire control sprinkler system shall be determined by adding the hose stream allowance from Table 15.1.1 to the water supply for sprinklers. This supply shall be available for the minimum duration specified in Table 15.1.1. (See Section C.8.)

Table 15.1.1 Hose Stream Allowance and Water Supply Duration

Commodity Classification	Storage Height		Inside Hose	
	ft	m	gpm	L/min
Group A plastic	< 5	< 1.5	0, 50, or 100	0, 190, 380
	Over 5 up to 20	Over 1.5 up to 6.1	0, 50, or 100	0, 190, 380
	Over 20 up to 25	Over 6.1 up to 7.6	0, 50, or 100	0, 190, 380

15.1.2* Storage Conditions.

15.1.2.1 The design of the sprinkler system shall be based on those conditions that routinely or periodically exist in a building and create the greatest water demand. These conditions

Copyright NFPA

include the following:

- (1) Pile height
- (2) Clearance
- (3) Pile stability
- (4) Array

15.2* Control Mode Density–Area Sprinkler Protection Criteria for Palletized, Solid Piled, Bin Box, or Shelf Storage of Plastic and Rubber Commodities.

15.2.1* Protection for plastic and rubber commodities shall be in accordance with Section 15.2. The decision tree shown in Figure 15.2.1 shall be used to determine the protection in each specific situation, subject to the following limitations:

- (1) Commodities that are stored palletized, solid piled, or in bin boxes up to 25 ft (7.62 m) in height
- (2) Commodities that are stored in shelf storage up to 15 ft (4.6 m) in height

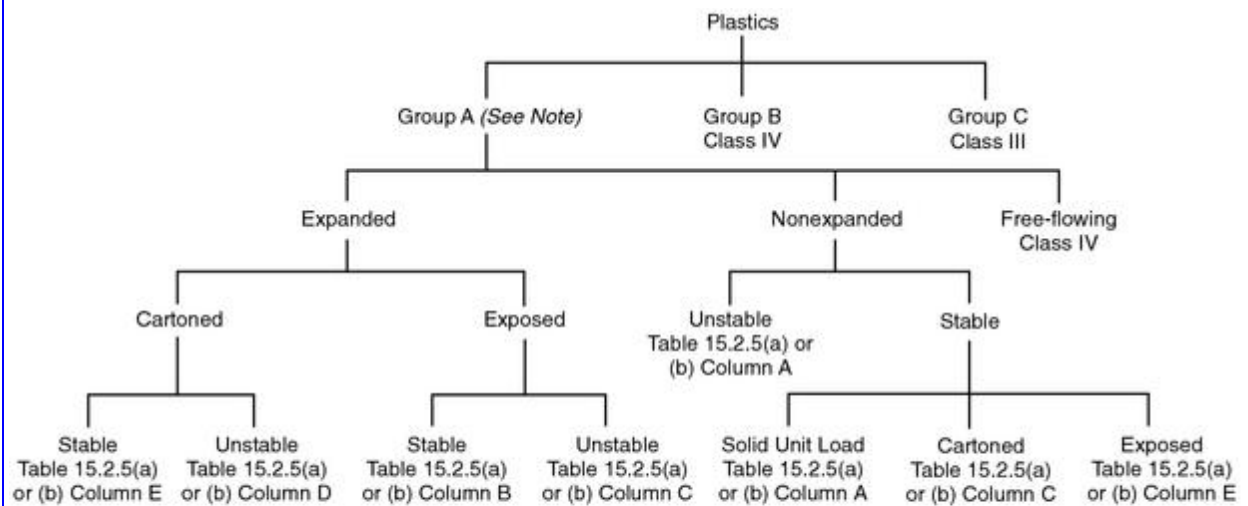

Note: Cartons that contain Group A plastic material shall be permitted to be treated as Class IV commodities under the following conditions:

- (1) There shall be multiple layers of corrugation or equivalent outer material that would significantly delay fire involvement of the Group A plastic.
- (2) The amount and arrangement of Group A plastic material within an ordinary carton would not be expected to significantly increase the fire hazard.

FIGURE 15.2.1 Decision Tree.

15.2.2* Factors affecting protection requirements such as closed/open array, clearance between storage and sprinklers, and stable/unstable piles shall be applicable only to storage of Group A plastics. This decision tree also shall be used to determine protection for commodities that are not wholly Group A plastics but contain such quantities and arrangements of the same that they are deemed more hazardous than Class IV commodities.

15.2.3 Group B plastics and free-flowing Group A plastics shall be protected in the same

manner as a Class IV commodity. (See Chapter 14 for protection of these storage commodities with spray sprinklers.)

15.2.4 Group C plastics shall be protected in the same manner as a Class III commodity. (See Chapter 14 for protection of these storage commodities with spray sprinklers.)

15.2.5* Design areas and densities for the appropriate storage configuration shall be selected from Table 15.2.5(a) or Table 15.2.5(b) as appropriate. Columns A, B, C, D, and E correspond to the protection required by the decision tree shown in Figure 15.2.1.

Table 15.2.5(a) Design Densities for Palletized, Solid-Piled, Bin Box, or Shelf Storage of Plastic and Rubber Commodities (U.S. Units)

Storage Height (ft)	Roof/Ceiling Height (ft)	Density (gpm/ft ²)				
		A	B	C	D	E
≤ 5	up to 25	OH2	OH2	OH2	OH2	OH2
≤ 12	up to 15	0.2	EH2	0.3	EH1	EH2
	>15 to 20	0.3	0.6	0.5	EH2	EH2
	>20 to 32	0.4	0.8	0.6	0.45	0.7
15	up to 20	0.3	0.6	0.5	0.4	0.45
	>20 to 25	0.4	0.8	0.6	0.45	0.7
	>25 to 35	0.45	0.9	0.7	0.55	0.85
20	up to 25	0.4	0.8	0.6	0.45	0.7
	>25 to 30	0.45	0.9	0.7	0.55	0.85
	>30 to 35	0.6	1.2	0.85	0.7	1.1
25	up to 30	0.45	0.9	0.7	0.55	0.85
	>30 to 35	0.6	1.2	0.85	0.7	1.1

Notes:

(1) Minimum clearance between sprinkler deflector and top of storage shall be maintained as required.

(2) Column designations correspond to the configuration of plastics storage as follows:

A: (1) Nonexpanded, unstable

(2) Nonexpanded, stable, solid unit load

B: Expanded, exposed, stable

C: (1) Expanded, exposed, unstable

(2) Nonexpanded, stable, cartoned

D: Expanded, cartoned, unstable

E: (1) Expanded, cartoned, stable

(2) Nonexpanded, stable, exposed

(3) OH2 = Density required by Figure 13.2.1 for Curve OH2

EH1 = Density required by Figure 13.2.1 for Curve EH1

EH2 = Density required by Figure 13.2.1 for Curve EH2

(4) Hose streams and durations shall be as follows: ≤ 5 ft 250 gpm (946 L/min) and 90 minutes; >5 ft to ≤ 20 ft 500 gpm (1900 L/min) and 120 minutes; >20 ft to ≤ 25 ft 500 gpm (1900 L/min) and 150 minutes.

Table 15.2.5(b) Design Densities for Palletized, Solid-Pile, Bin-Box, or Shelf Storage of Plastic and Rubber Commodities (Metric Units)

(ft)	(ft)	A	B	C	D	E
------	------	---	---	---	---	---

Table 15.2.5(b) Design Densities for Palletized, Solid-Pile, Bin-Box, or Shelf Storage of Plastic and Rubber Commodities (Metric Units)

Storage Height (m)	Roof/Ceiling Height (m)	Density (mm/min)				
		A	B	C	D	E
≤1.5	Up to 7.6	OH2	OH2	OH2	OH2	OH2
≤3.6	Up to 4.6	8.2	EH2	12.2	EH1	EH2
	>4.6 to 6.1	12.2	24.5	20.4	EH2	EH2
	>6.1 to 9.8	16.3	32.6	24.5	18.4	28.6
4.6	Up to 6.1	12.2	24.5	20.4	16.3	18.4
	>6.1 to 7.6	16.3	32.6	24.5	18.4	28.6
	>7.6 to 10.7	18.4	36.7	28.6	22.4	34.7
6.1	Up to 7.6	16.3	32.6	24.5	18.4	28.6
	>7.6 to 9.1	18.4	36.7	28.6	22.4	34.7
	>9.1 to 10.7	24.5	49.0	34.7	28.6	44.9
7.6	Up to 9.1	18.4	36.7	28.6	22.4	34.7
	>9.1 to 10.7	24.5	49.0	34.7	28.6	44.9

Notes:

- (1) Minimum clearance between sprinkler deflector and top of storage shall be maintained as required.
- (2) Column designations correspond to the configuration of plastics storage as follows:
 - A: (1) Nonexpanded, unstable
(2) Nonexpanded, stable, solid unit load
 - B: Expanded, exposed, stable
 - C: (1) Expanded, exposed, unstable
(2) Nonexpanded, stable, cartoned
 - D: Expanded, cartoned, unstable
 - E: (1) Expanded, cartoned, stable
(2) Nonexpanded, stable, exposed
- (3) OH2 = Density required by Figure 13.2.1 for Curve OH2
 EH1 = Density required by Figure 13.2.1 for Curve EH1
 EH2 = Density required by Figure 13.2.1 for Curve EH2
- (4) Hose streams and durations shall be as follows: ≤ 5 ft 250 gpm (946 L/min) and 90 minutes; >5 ft to ≤20 ft 500 gpm (1900 L/min) and 120 minutes; >20 ft to ≤25 ft 500 gpm (1900 L/min) and 150 minutes.

15.2.6 The ceiling only protection criteria specified in Chapter 17 for rack storage of plastic and rubber commodities shall be permitted to be used for solid piled palletized storage of the same commodity, at the same height and clearance.

15.2.7 For Table 15.2.5(a) and Table 15.2.5(b), the design areas shall be as follows:

- (1) The area shall be a minimum of 2500 ft² (232 m²).
- (2) Where Table 15.2.5(a) and Table 15.2.5(b) allow densities and areas to be selected in accordance with Figure 13.2.1, Curve OH2, Curve EH1, and Curve EH2, any density

area from the curves in Figure 13.2.1 shall be permitted.

- (3) For closed arrays, the area shall be permitted to be reduced to 2000 ft² (186 m²).

15.2.8 Interpolation of densities between storage heights shall be required. Densities shall be based on the 2500 ft² (232 m²) design area. The “up to” in Table 15.2.5(a) and Table 15.2.5(b) is intended to aid in the interpolation of densities between storage heights. Interpolation of ceiling/roof heights shall not be permitted.

15.3 Large Drop Sprinklers and Specific Application Control Mode Sprinklers for Palletized or Solid-Piled of Plastic and Rubber Commodities.

15.3.1 Protection of palletized and solid-piled storage of unexpanded plastic and expanded plastic commodities shall be in accordance with Table 15.3.1(a) or Table 15.3.1(b).

Table 15.3.1(a) Large Drop Sprinkler Design Criteria for Palletized and Solid-Piled

Storage Arrangement	Commodity Class	Nominal K-Factor	Maximum Storage Height		Maximum Ceiling/ Roof Height		Type of System	Number of Sprinklers per Area	
			ft	m	ft	m		psi	
Palletized	Cartoned or exposed unexpanded plastics	11.2 (161)	20	6.1	30	9.1	Wet	25/25	
							Dry	N/A	
	Cartoned or exposed expanded plastics	11.2 (161)	18	5.5	26	7.9	Wet	15/50	
							Dry	N/A	
Solid-piled	Cartoned or exposed unexpanded plastics	11.2 (161)	20	6.1	30	9.1	Wet	15/50	
							Dry	N/A	

Table 15.3.1(b) Specific Application Control Mode [16.8 K-Factor (242)] Sprinkler Design Criteria for Storage of Plastic and Rubber Commodities

Configuration	Commodity Class	Maximum Storage Height		Maximum Building Height		Type of System	Number of Design Sprinklers per Area by Minimum Pressure	
		ft	m	ft	m		10 psi (0.7 bar)	
Palletized	Cartoned or exposed unexpanded plastics	25	7.6	30	9.1	Wet	—	

**Table 15.3.1(b) Specific Application Control Mode [16.8 K-Factor (242)] Sprinkler E
Storage of Plastic and Rubber Commodities**

Configuration	Commodity Class	Maximum Storage Height		Maximum Building Height		Type of System	Number of Design by Minimum Pressure	
		ft	m	ft	m		10 psi (0.7 bar)	
Solid-piled	Cartoned or exposed unexpanded plastics	25	7.6	30	9.1	Wet	—	

15.3.2 Protection shall be provided as specified in Table 15.3.1(a) and Table 15.3.1(b) or appropriate NFPA standards in terms of minimum operating pressure and the number of sprinklers to be included in the design area.

15.3.3 Open Wood Joist Construction.

15.3.3.1 Where large drop K-11.2 (161) sprinklers are installed under open wood joist construction, their minimum operating pressure shall be 50 psi (3.4 bar).

15.3.3.2 Where each joist channel of open, wood joist construction is fully fire-stopped to its full depth at intervals not exceeding 20 ft (6.1 m), the lower pressures specified in Table 15.3.1(a) shall be permitted to be used.

15.3.4 The design area shall be a rectangular area having a dimension parallel to the branch lines at least 1.2 times the square root of the area protected by the number of sprinklers to be included in the design area. Any fractional sprinkler shall be included in the design area.

15.3.5 Hose stream allowance and water supply duration requirements shall be in accordance with Table 15.3.1(a) and Table 15.3.1(b).

15.3.6 Preaction Systems. For the purpose of using 15.3.1, preaction systems shall be classified as dry pipe systems.

15.3.7 Building steel shall not require special protection where Table 15.3.1(a) or Table 15.3.1(b) is applied as appropriate for the storage configuration.

15.4 Early Suppression Fast-Response (ESFR) Sprinklers for Palletized, Solid Piled of Plastic and Rubber Commodities.

15.4.1 Protection of palletized and solid-piled storage of cartoned or uncartoned unexpanded plastic and cartoned expanded plastic shall be in accordance with Table 15.4.1.

Table 15.4.1 ESFR Protection of Palletized and Solid-Piled Storage of P

15.4 Early Suppression Fast-Response (ESFR) Sprinklers for Palletized, Solid Piled of Plastic and Rubber Commodities.

15.4.1 Protection of palletized and solid-piled storage of cartoned or uncartoned unexpanded plastic and cartoned expanded plastic shall be in accordance with Table 15.4.1.

Table 15.4.1 ESFR Protection of Palletized and Solid-Piled Storage of P

Storage Arrangement	Commodity	Maximum Storage Height		Maximum Ceiling/ Roof Height		Nominal K-Factor	Orientation	
		ft	m	ft	m			

Table 15.4.1 ESFR Protection of Palletized and Solid-Piled Storage of P

Storage Arrangement	Commodity	Maximum Storage Height		Maximum Ceiling/ Roof Height		Nominal K-Factor	Orientation
		ft	m	ft	m		
Palletized and solid-piled storage (no open-top containers or solid shelves)	Cartoned unexpanded plastic	20	6.1	25	7.6	14.0 (201)	Upright or pendent
						16.8 (242)	Upright/ Pendent
						22.4 (322)	Pendent
						25.2 (363)	Pendent
						14.0 (201)	Upright or pendent
						16.8 (242)	Upright/ Pendent
						22.4 (322)	Pendent
						25.2 (363)	Pendent
				35	7.6	14.0 (201)	Upright/ Pendent
						16.8 (242)	Upright/ Pendent
						22.4 (322)	Pendent
						25.2 (363)	Pendent
				40	12.2	14.0 (201)	Pendent
						16.8 (242)	Pendent
						22.4 (322)	Pendent
						25.2 (363)	Pendent
				45	13.7	22.4 (322)	Pendent
						25.2 (363)	Pendent
				30	9.1	14.0 (201)	Upright or pendent
						16.8 (242)	Upright/ Pendent
22.4 (322)	Pendent						

Table 15.4.1 ESFR Protection of Palletized and Solid-Piled Storage of F

Storage Arrangement	Commodity	Maximum Storage Height		Maximum Ceiling/ Roof Height		Nominal K-Factor	Orientation
		ft	m	ft	m		
		25	7.6	32	9.8	25.2 (363)	Pendent
						14.0 (201)	Upright or pendent
				35	7.6	16.8 (242)	Upright/ Pendent
						14.0 (201)	Upright or pendent
						16.8 (242)	Upright/ Pendent
				35	7.6	22.4 (322)	Pendent
						25.2 (363)	Pendent
				40	12.2	14.0 (201)	Pendent
						16.8 (242)	Pendent
						22.4 (322)	Pendent
		25.2 (363)	Pendent				
		45	13.7	22.4 (322)	Pendent		
				25.2 (363)	Pendent		
		30	9.1	35	10.7	14.0 (201)	Upright or pendent
						16.8 (242)	Upright/ Pendent
						22.4 (322)	Pendent
						25.2 (363)	Pendent
				40	12.2	14.0 (201)	Pendent
						16.8 (242)	Pendent
						22.4 (322)	Pendent
25.2 (363)	Pendent						

Table 15.4.1 ESFR Protection of Palletized and Solid-Piled Storage of F

Storage Arrangement	Commodity	Maximum Storage Height		Maximum Ceiling/ Roof Height		Nominal K-Factor	Orientation
		ft	m	ft	m		
				45	13.7	22.4 (322)	Pendent
						25.2 (363)	Pendent
	Cartoned unexpanded plastic (continued)	35	10.7	40	12.2	14.0 (201)	Pendent
						16.8 (242)	Pendent
						22.4 (322)	Pendent
						25.2 (363)	Pendent
				45	13.7	22.4 (322)	Pendent
						25.2 (363)	Pendent

Table 15.4.1 ESRF Protection of Palletized and Solid-Piled Storage of P

Storage Arrangement	Commodity	Maximum Storage Height		Maximum Ceiling/ Roof Height		Nominal K-Factor	Orientation		
		ft	m	ft	m				
		40	12.2	45	13.7	22.4 (322)	Pendent		
						25.2 (363)	Pendent		
	Exposed unexpanded plastic	20	6.1	25	7.6	14.0 (201)	Pendent		
							16.8 (242)	Pendent	
						30	9.1	14.0 (201)	Pendent
								16.8 (242)	Pendent
				35	10.7	14.0 (201)	Pendent		
						16.8 (242)	Pendent		
						14.0 (201)	Pendent		
						16.8 (242)	Pendent		
				40	12.2	14.0 (201)	Pendent		
						16.8 (242)	Pendent		
						14.0 (201)	Pendent		
						16.8 (242)	Pendent		
	25	7.6	30	9.1	14.0 (201)	Pendent			
					16.8 (242)	Pendent			
			32	9.8	14.0 (201)	Pendent			
					16.8 (242)	Pendent			
			35	10.7	14.0 (201)	Pendent			
					16.8 (242)	Pendent			
40			12.2	14.0 (201)	Pendent				
				16.8 (242)	Pendent				
	25.2 (363)	Pendent							
						14.0	Pendent		

Table 15.4.1 ESFR Protection of Palletized and Solid-Piled Storage of P

Storage Arrangement	Commodity	Maximum Storage Height		Maximum Ceiling/ Roof Height		Nominal K-Factor	Orientation	
		ft	m	ft	m			
		30	9.1	35	10.7	(201)	Pendent	
						16.8 (242)		
				40	12.2	14.0 (201)	Pendent	
						16.8 (242)	Pendent	
						25.2 (363)	Pendent	
						14.0 (201)	Pendent	
		35	10.7	40	12.2	16.8 (242)	Pendent	
						25.2 (363)	Pendent	
						14.0 (201)	Pendent	
		Cartoned expanded plastic	20	6.1	25	7.6	14.0 (201)	Upright or pendent
							16.8 (242)	Upright/ Pendent
					30	9.1	14.0 (201)	Upright or pendent
	16.8 (242)						Upright/ Pendent	
	25		7.6	30	9.1	14.0 (201)	Upright or pendent	
						16.8 (242)	Upright/ Pendent	
				32	9.8	14.0 (201)	Pendent	
16.8 (242)						Upright/ Pendent		
Exposed* expanded plastic	25	7.5	40	12.2	25.2 (363)	Pendent		

* Applies to closed array storage only.

15.4.2 ESFR sprinkler systems shall be designed such that the minimum operating pressure is not less than that indicated in Table 15.4.1 for type of storage, commodity, storage height, and building height involved.

15.4.3 The design area shall consist of the most hydraulically demanding area of 12

sprinklers, consisting of four sprinklers on each of three branch lines.

15.4.4 Where ESFR sprinklers are installed above and below obstructions, the discharge for up to two sprinklers for one of the levels shall be included with those of the other level in the hydraulic calculations.

15.4.5 Special Design for Palletized, Solid-Piled, Bin Box, or Shelf Storage of Plastic and Rubber Commodities. (Reserved)

15.5 High Expansion Foam — Reduction to Ceiling Density.

A reduction in ceiling density to one-half that required for Class I through Class IV commodities, idle pallets, or plastics shall be permitted without revising the design area, but the density shall be no less than 0.15 gpm/ft² (6.1 mm/min).

Chapter 16 Protection of Class I Through Class IV Commodities That Are Stored on Racks

16.1 General.

16.1.1 This section shall apply to storage of materials representing the broad range of combustibles stored in racks. The requirements of Chapter 12 shall apply unless modified by this chapter. (*See Section C.9.*)

16.1.2* Sprinkler Protection Criteria.

16.1.2.1 Sprinkler protection criteria for the storage of materials on racks shall be in accordance with Section 16.2 for storage up to 25 ft (7.6 m), and Section 16.3 for storage over 25 ft (7.6 m).

16.1.2.2* Protection criteria for Group A plastics shall be permitted for the protection of the same storage height and configuration of Class I, II, III, and IV commodities.

16.1.3 Movable Racks. Rack storage in movable racks shall be protected in the same manner as multiple-row racks.

16.1.4 Fire Protection of Steel Columns — Columns Within Storage Racks of Class I Through Class IV and Plastic Commodities. (*See Section C.10.*)

16.1.4.1 Where sprinkler protection of building columns within the rack structure or vertical rack members supporting the building are installed in lieu of fireproofing, sprinkler protection in accordance with one of the following shall be provided:

- (1) Sidewall sprinklers at the 15 ft (4.6 m) elevation, pointed toward one side of the steel column
- (2) Provision of ceiling sprinkler density for a minimum of 2000 ft² (186 m²) with ordinary 165°F (74°C) or high-temperature 286°F (141°C) rated sprinklers as shown in Table 16.1.4.1 for storage heights above 15 ft (4.6 m), up to and including 20 ft

- (6.1 m)
- (3) Provision of large drop, specific application control mode or ESFR ceiling sprinkler protection
 - (4) This protection shall not be required where storage in fixed racks is protected by in-rack sprinklers.

Table 16.1.4.1 Ceiling Sprinkler Densities for Protection of Steel Building Columns

Commodity Classification	Aisle Width			
	4 ft (1.2 m)		8 ft (2.4 m)	
	gpm/ft ²	(L/min)/m ²	gpm/ft ²	(L/min)/m ²
Class I	0.37	15.1	0.33	13.5
Class II	0.44	17.9	0.37	15.1
Class III	0.49	20	0.42	17.1
Class IV and Plastics	0.68	27.7	0.57	23.2

16.1.4.2 The flow from a column sprinkler(s) shall be permitted to be omitted from the sprinkler system hydraulic calculations.

16.1.5 High-Expansion Foam.

16.1.5.1 High-Expansion Foam Ceiling Sprinkler Density.

16.1.5.1.1 Where high-expansion foam systems are used in combination with ceiling sprinklers, the minimum ceiling sprinkler design density shall be 0.2 gpm/ft² (8.1 mm/min) for Class I, Class II, or Class III commodities or 0.25 gpm/ft² (10.2 mm/min) for Class IV commodities for the most hydraulically remote 2000 ft² (186 m²) operating area.

16.1.5.1.2 Where high-expansion foam systems are used in combination with ceiling sprinklers, the maximum submergence time shall be 7 minutes for Class I, Class II, or Class III commodities and 5 minutes for Class IV commodities.

16.1.5.1.3 Where high-expansion foam systems are used for storage over 25 ft (7.6 m) high up to and including 35 ft (10.7 m) high, they shall be used in combination with ceiling sprinklers. The maximum submergence time for the high-expansion foam shall be 5 minutes for Class I, Class II, or Class III commodities and 4 minutes for Class IV commodities.

16.1.5.2 In-rack sprinklers shall not be required where high-expansion foam systems are used in combination with ceiling sprinklers.

16.1.5.3 Detectors for High-Expansion Foam Systems.

16.1.5.3.1 Detectors shall be listed and shall be installed in one of the following configurations:

- (1) At the ceiling only where installed at one-half the listed linear spacing [e.g., 15 ft × 15 ft (4.6 m × 4.6 m) rather than at 30 ft × 30 ft (9.1 m × 9.1 m)]; at the ceiling at the listed spacing and in racks at alternate levels

- (2) Where listed for rack storage installation and installed in accordance with the listing to provide response within 1 minute after ignition using an ignition source that is equivalent to that used in a rack storage testing program

16.1.5.3.2 Ceiling detectors alone shall not be used where the ceiling/roof clearance from the top of the storage exceeds 10 ft (3.1 m) or the height of the storage exceeds 25 ft (7.6 m).

16.1.5.4 Detectors for preaction systems shall be installed in accordance with 16.1.5.3.

16.1.6 Solid Shelving.

16.1.6.1 Where solid shelving in single-, double-, and multiple-row racks exceeds 20 ft² (1.86 m²) but does not exceed 64 ft² (5.95 m²) in area, sprinklers shall not be required below every shelf, but shall be installed at the ceiling and below shelves at intermediate levels not more than 6 ft (2 m) apart vertically. (*See Section C.11.*)

16.1.6.2 Where solid shelving in single-, double-, and multiple-row racks exceeds 64 ft² (5.95 m²) in area or where the levels of storage exceed 6 ft (2 m), sprinklers shall be installed at the ceiling and below each level of shelving.

16.1.6.3 In-rack sprinklers shall be horizontally spaced in accordance with 16.2.4.2 and 16.3.4.2 as applicable.

16.1.6.4 Design criteria for combined ceiling and in-rack sprinklers shall be used for the storage configurations in 16.1.6.1 and 16.1.6.2.

16.1.7 Open-Top Combustible Containers. See Section C.12.

16.1.8 In-Rack Sprinklers.

16.1.8.1 The number of sprinklers and the pipe sizing on a line of sprinklers in racks shall be restricted only by hydraulic calculations and not by any piping schedule.

16.1.8.2 When in-rack sprinklers are necessary to protect a higher-hazard commodity that occupies only a portion of the length of a rack, in-rack sprinklers shall be extended a minimum of 8 ft (2.44 m) or one bay, whichever is greater, in each direction along the rack on either side of the higher hazard. The in-rack sprinklers protecting the higher hazard need not be extended across the aisle.

16.1.8.3 Where a storage rack, due to its length, requires less than the number of in-rack sprinklers specified, only those in-rack sprinklers in a single rack need to be included in the calculation.

16.1.9* Horizontal Barriers and In-Rack Sprinklers. Horizontal barriers used in conjunction with in-rack sprinklers to impede vertical fire development shall be constructed of sheet metal, wood, or similar material and shall extend the full length and depth of the rack. Barriers shall be fitted within 2 in. (51 mm) horizontally around rack uprights.

16.1.10 Flue Space Requirements for Storage Up to and Including 25 ft (7.6 m). In double-row and multiple-row racks without solid shelves, a longitudinal (back-to-back clearance between loads) flue space shall not be required. Nominal 6 in. (152.4 mm)

transverse flue spaces between loads and at rack uprights shall be maintained in single-row, double-row, and multiple-row racks. Random variations in the width of flue spaces or in their vertical alignment shall be permitted. (See Section C.13.)

16.1.11 Flue Space Requirements for Storage Over 25 ft (7.6 m).

16.1.11.1 Nominal 6 in. (152.4 mm) transverse flue spaces between loads and at rack uprights shall be maintained in single-row, double-row, and multiple-row racks. Nominal 6 in. (152.4 mm) longitudinal flue spaces shall be provided in double-row racks. Random variations in the width of the flue spaces or in their vertical alignment shall be permitted.

16.1.11.2 In single-row, double-row, or multiple-row racks, a minimum 6 in. (152.4 mm) vertical clear space shall be maintained between the sprinkler deflectors and the top of a tier of storage. Face sprinklers in such racks shall be located a minimum of 3 in. (76 mm) from rack uprights and no more than 18 in. (460 mm) from the aisle face of storage. Longitudinal flue in-rack sprinklers shall be located at the intersection with the transverse flue space and with the deflector located at or below the bottom of horizontal load beams or above or below other adjacent horizontal rack members. Such in-rack sprinklers shall be a minimum of 3 in. (76 mm) radially from the side of the rack uprights.

16.2 Protection Criteria for Rack Storage of Class I Through Class IV Commodities Stored Up to and Including 25 ft (7.6 m) in Height.

16.2.1 Control Mode Density-Area Sprinkler Protection Criteria for Rack Storage of Class I Through Class IV Commodities Stored Up to and Including 25 ft (7.6 m) in Height.

16.2.1.1 The area and density for the hydraulically remote area and the water supply shall be determined as specified in 16.2.1.2 for storage up to 12 ft (3.7 m) and 16.2.1.3 to 16.2.1.3.5 for storage over 12 ft (3.7 m).

16.2.1.2 Protection Criteria for Rack Storage of Class I Through IV Commodities Stored Up to 12 ft (3.7 m) in Height.

16.2.1.2.1 The protection criteria for storage up to and including 12 ft (3.7 m) shall be the same as miscellaneous storage, selected from Chapter 13. The protection criteria in Chapter 13 shall be acceptable for storage of Class I through IV commodities up to and including 12 ft (3.7 m) in height. See Table 13.2.1 for specific Class I through IV storage height protection criteria.

16.2.1.3 Protection Criteria for Rack Storage of Class I Through Class IV Commodities Stored Over 12 ft (3.7 m) in Height.

16.2.1.3.1* Ceiling sprinkler water demand shall be determined in accordance with 16.2.1.3.2 for single- and double-row racks or 16.2.1.3.3 for multiple-row racks. (See Section C.14.)

16.2.1.3.2* For single- or double-row racks for Class I, Class II, Class III, or Class IV commodities, encapsulated or nonencapsulated in single- or double-row racks, ceiling sprinkler water demand in terms of density [gpm/ft² (mm/min)] and area of sprinkler operation [ft² (m²) of ceiling or roof] shall be selected from the density–area curves of Figure
Copyright NFPA

16.2.1.3.2(a) through Figure 16.2.1.3.2(g) that are appropriate for each commodity and configuration as shown in Table 16.2.1.3.2 and shall be modified as appropriate by 16.2.1.3.4. These requirements shall apply to portable racks arranged in the same manner as single- or double-row racks.

Table 16.2.1.3.2 Single- or Double-Row Racks — Storage Height Over 12 ft (3.7 m) Up to

Height	Commodity Class	Encapsulated	Aisles*		Sprinklers Mandatory In-Rack	With In-Rack Sprinklers	
			ft	m		Figure	Curves
Over 12 ft (3.7 m), up to and including 20 ft (6.1 m)	I	No	4	1.2	No	16.2.1.3.2(a)	C and I
			8	2.4			A and F
		Yes	4	1.2	No	16.2.1.3.2(e)	C and I
			8	2.4			A and F
	II	No	4	1.2	No	16.2.1.3.2(b)	C and I
			8	2.4			A and F
		Yes	4	1.2	No	16.2.1.3.2(e)	C and I
			8	2.4			A and F
	III	No	4	1.2	No	16.2.1.3.2(c)	C and I
			8	2.4			A and F
		Yes	4	1.2	1 level	16.2.1.3.2(f)	C and I
			8	2.4			A and F
IV	No	4	1.2	No	16.2.1.3.2(d)	C and I	
		8	2.4			A and F	
	Yes	4	1.2	1 level	16.2.1.3.2(g)	C and I	
		8	2.4			A and F	
Over 20 ft (6.1 m), up to and including 22 ft (6.7 m)	I	No	4	1.2	No	16.2.1.3.2(a)	C and I
			8	2.4			A and F
		Yes	4	1.2	1 level	16.2.1.3.2(e)	C and I
			8	2.4			A and F
	II	No	4	1.2	No	16.2.1.3.2(b)	C and I
			8	2.4			A and F
		Yes	4	1.2	1 level	16.2.1.3.2(e)	C and I
			8	2.4			A and F
	III	No	4	1.2	No	16.2.1.3.2(c)	C and I
			8	2.4			A and F
		Yes	4	1.2	1 level	16.2.1.3.2(f)	C and I
			8	2.4			A and F
IV	No	4	1.2	No	16.2.1.3.2(d)	C and I	
		8	2.4			A and F	
	Yes	4	1.2	1 level	16.2.1.3.2(g)	C and I	
		8	2.4			A and F	

Table 16.2.1.3.2 Single- or Double-Row Racks — Storage Height Over 12 ft (3.7 m) Up to

Height	Commodity Class	Encapsulated	Aisles*		Sprinklers Mandatory In-Rack	With In-Rack Spri	
			ft	m		Figure	Curves
Over 22 ft (6.7 m), up to and including 25 ft (7.6 m)	I	No	4	1.2	No	16.2.1.3.2(a)	C and I
			8	2.4			A and F
		Yes	4	1.2	1 level	16.2.1.3.2(e)	C and I
			8	2.4			A and F
	II	No	4	1.2	No	16.2.1.3.2(b)	C and I
			8	2.4			A and F
		Yes	4	1.2	1 level	16.2.1.3.2(e)	C and I
			8	2.4			A and F
	III	No	4	1.2	No	16.2.1.3.2(c)	C and I
			8	2.4			A and F
		Yes	4	1.2	1 level	16.2.1.3.2(f)	C and I
			8	2.4			A and F
IV	No	4	1.2	1 level	16.2.1.3.2(d)	C and I	
		8	2.4			A and F	
	Yes	4	1.2	1 level	16.2.1.3.2(g)	C and I	
		8	2.4			A and F	

*See 16.2.1.2.1 for interpolation of aisle widths.

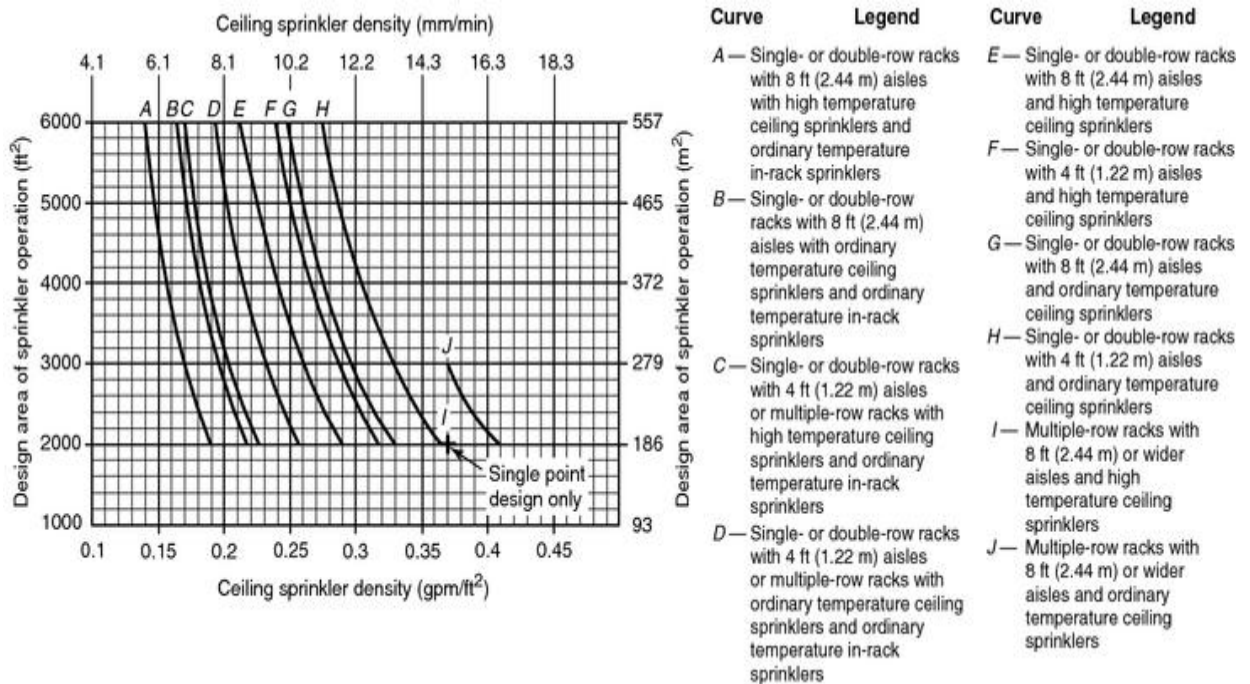

FIGURE 16.2.1.3.2(a) Sprinkler System Design Curves — 20 ft (6.1 m) High Rack

Storage — Class I Nonencapsulated Commodities — Conventional Pallets.

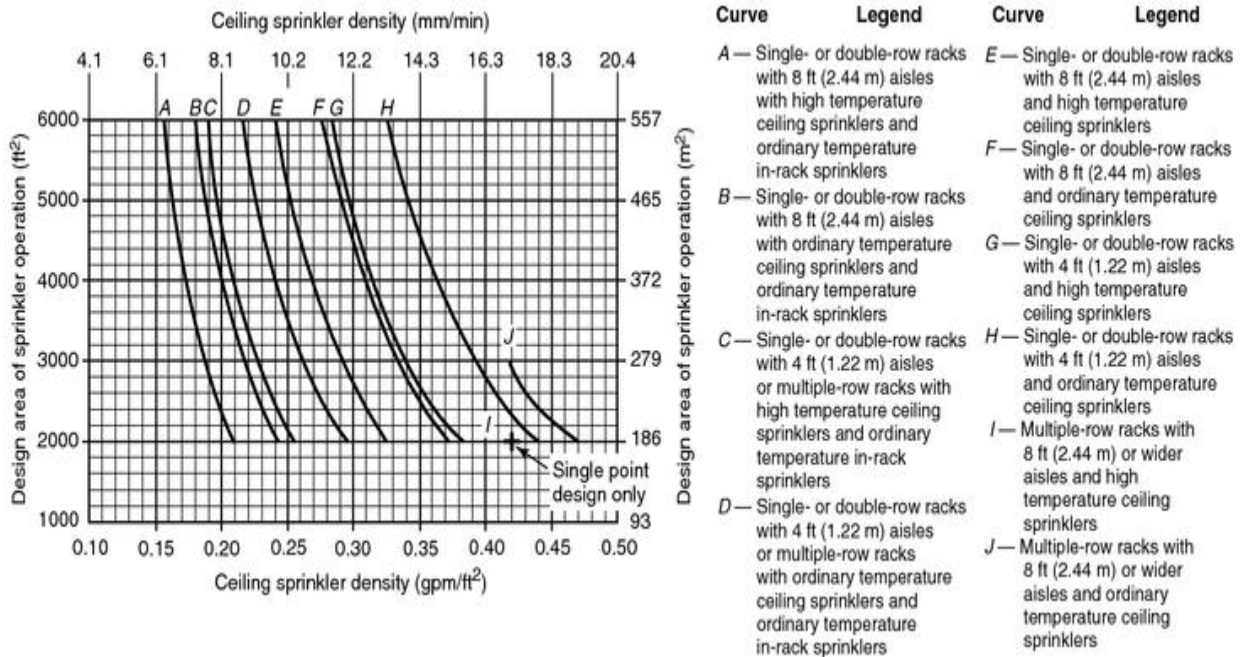

FIGURE 16.2.1.3.2(b) Sprinkler System Design Curves — 20 ft (6.1 m) High Rack Storage — Class II Nonencapsulated Commodities — Conventional Pallets.

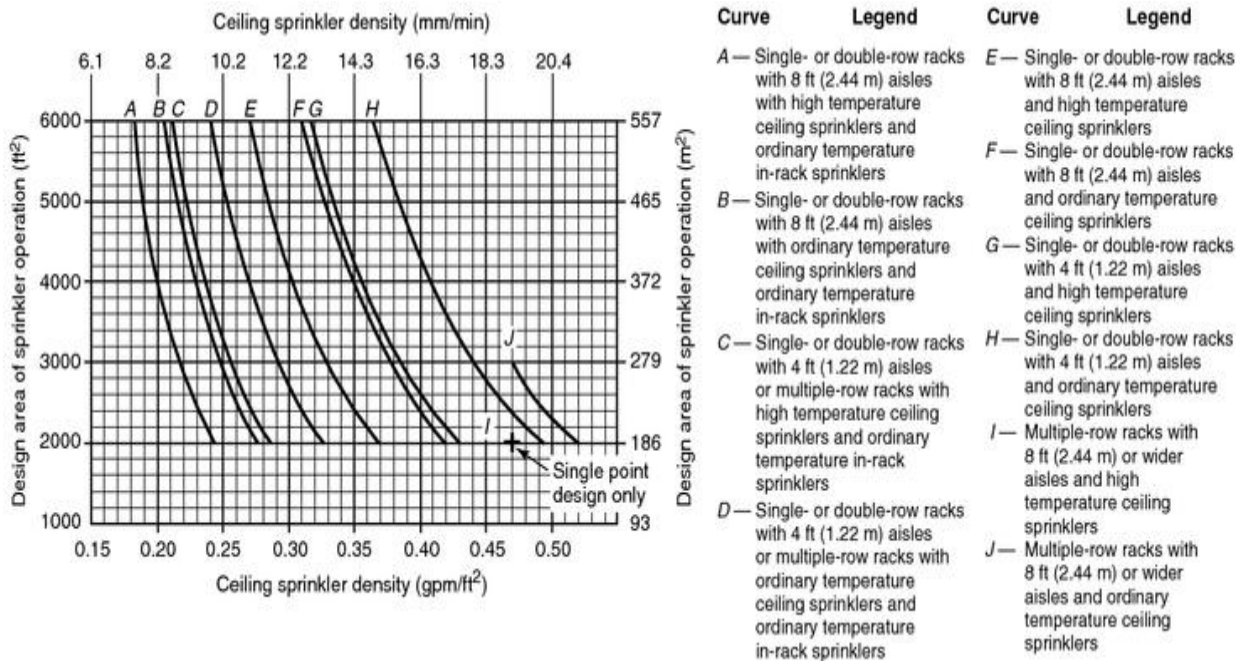

FIGURE 16.2.1.3.2(c) Sprinkler System Design Curves — 20 ft (6.1 m) High Rack Storage — Class III Nonencapsulated Commodities — Conventional Pallets.

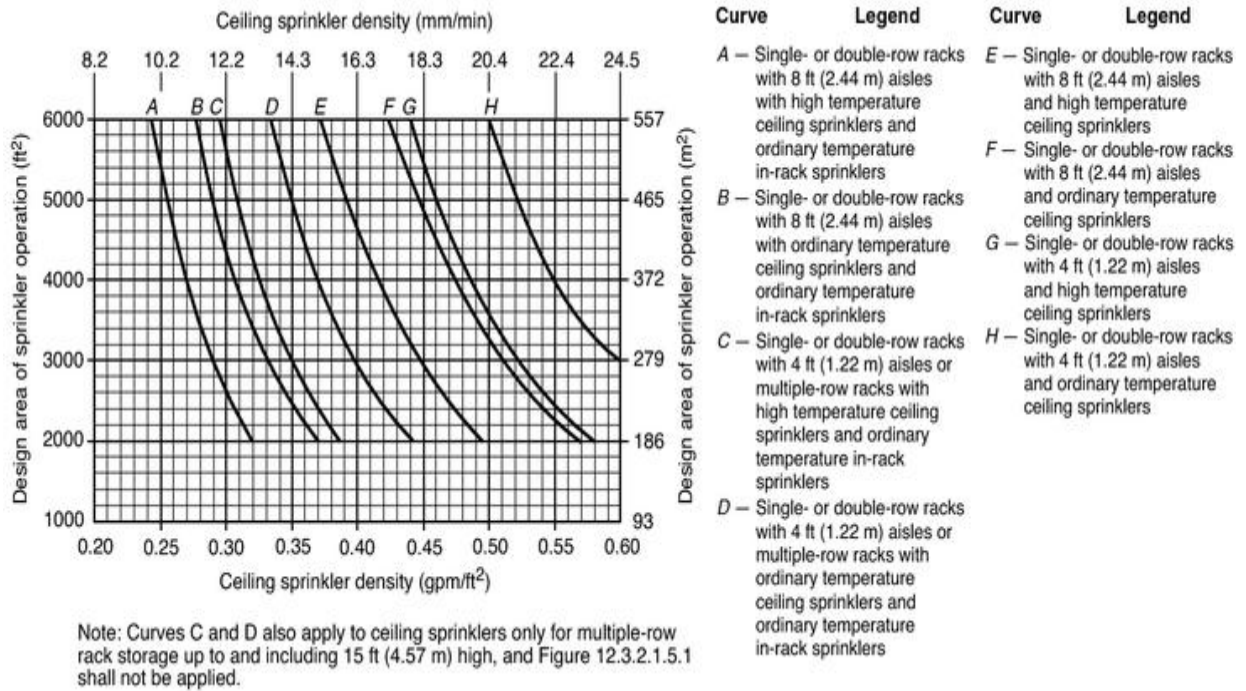

FIGURE 16.2.1.3.2(d) Sprinkler System Design Curves — 20 ft (6.1 m) High Rack Storage — Class IV Nonencapsulated Commodities — Conventional Pallets.

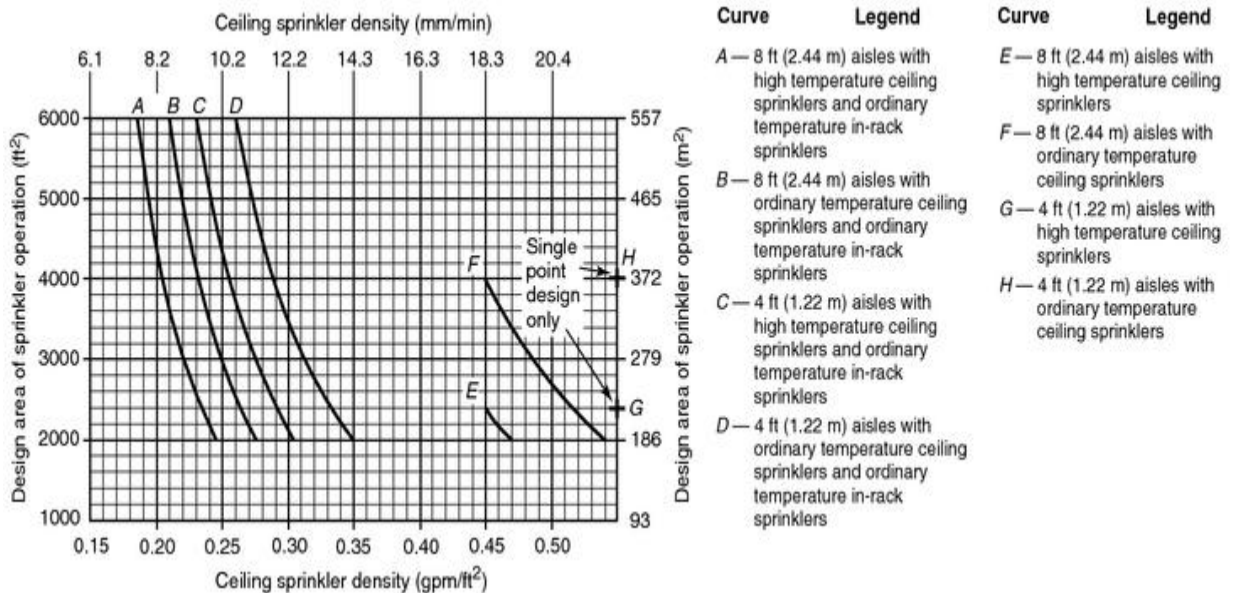
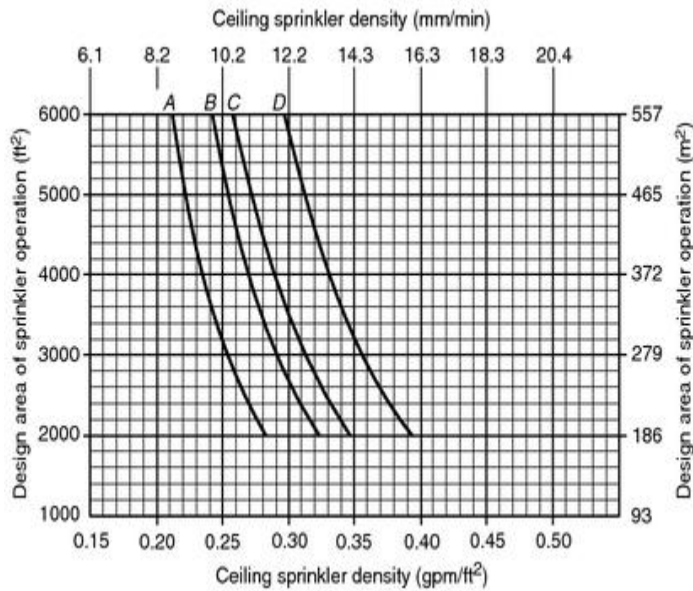
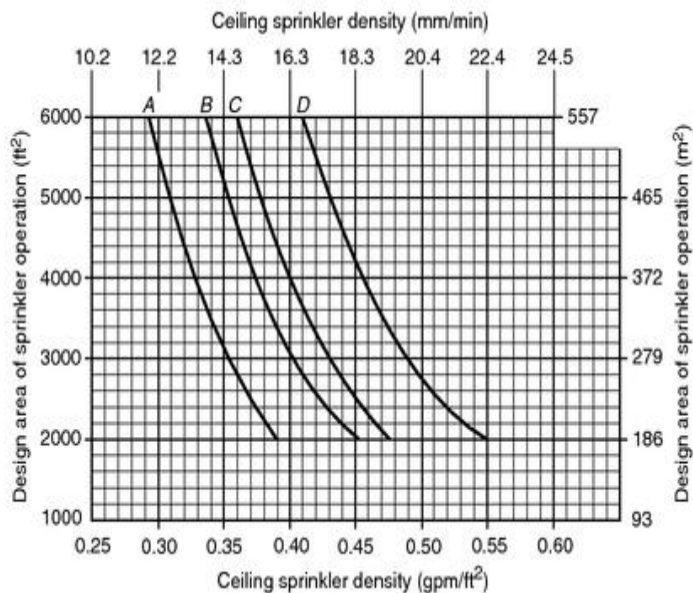

FIGURE 16.2.1.3.2(e) Single- or Double-Row Racks — 20 ft (6.1 m) High Rack Storage — Sprinkler System Design Curves — Class I and Class II Encapsulated Commodities — Conventional Pallets.



Curve	Legend	Curve	Legend
A	8 ft (2.44 m) aisles with high temperature ceiling sprinklers and ordinary temperature in-rack sprinklers	C	4 ft (1.22 m) aisles with high temperature ceiling sprinklers and ordinary temperature in-rack sprinklers
B	8 ft (2.44 m) aisles with ordinary temperature ceiling sprinklers and ordinary temperature in-rack sprinklers	D	4 ft (1.22 m) aisles with ordinary temperature ceiling sprinklers and ordinary temperature in-rack sprinklers

FIGURE 16.2.1.3.2(f) Single- or Double-Row Racks — 20 ft (6.1 m) High Rack Storage — Sprinkler System Design Curves — Class III Encapsulated Commodities — Conventional Pallets.



Curve	Legend	Curve	Legend
A	8 ft (2.44 m) aisles with high temperature ceiling sprinklers and ordinary temperature in-rack sprinklers	C	4 ft (1.22 m) aisles with high temperature ceiling sprinklers and ordinary temperature in-rack sprinklers
B	8 ft (2.44 m) aisles with ordinary temperature ceiling sprinklers and ordinary temperature in-rack sprinklers	D	4 ft (1.22 m) aisles with ordinary temperature ceiling sprinklers and ordinary temperature in-rack sprinklers

FIGURE 16.2.1.3.2(g) Single- or Double-Row Racks — 20 ft (6.1 m) High Rack Storage — Sprinkler System Design Curves — Class IV Encapsulated Commodities — Conventional Pallets.

16.2.1.3.2.1* Design densities for single- and double-row racks shall be selected to correspond to aisle width. For aisle widths between 4 ft (1.2 m) and 8 ft (2.4 m), a direct linear interpolation between densities shall be made. The density given for 8 ft (2.4 m) wide aisles shall be applied to aisles wider than 8 ft (2.4 m). The density given for 4 ft (1.2 m) wide aisles shall be applied to aisles narrower than 4 ft (1.2 m) down to 3½ ft (1.07 m). Where aisles are narrower than 3½ ft (1.07 m), racks shall be considered to be multiple-row

racks. (See Section C.15.)

16.2.1.3.3 Multiple-Row Racks — Storage Height Over 12 ft (3.7 m) Up to and Including 25 ft (7.6 m) Without Solid Shelves.

16.2.1.3.3.1 Multiple-Row Racks — Rack Depth Up to and Including 16 ft (4.9 m) with Aisles 8 ft (2.4 m) or Wider. For Class I, Class II, Class III, or Class IV commodities, encapsulated or nonencapsulated, ceiling sprinkler water demand in terms of density [gpm/ft² (mm/min)] and area of sprinkler operation [ft² (m²) of ceiling or roof] shall be selected from the density–area curves of Figure 16.2.1.3.2(a) through Figure 16.2.1.3.2(g) that are appropriate for each commodity and configuration as shown in Table 16.2.1.3.3.1 and shall be modified as appropriate by 16.2.1.3.4. The protection criteria shall apply to portable racks arranged in the same manner as single- or double-row racks.

Table 16.2.1.3.3.1 Multiple-Row Racks — Rack Depth Up to and Including 16 ft (4.9 m) 12 ft (3.7 m) Up to 25 ft (7.6 m)

Height	Commodity Class	Encapsulated	Sprinklers Mandatory In-Racks	Ceiling Spr			
				With In-Rack Sprinklers			
				Figure	Curves	Apply Figure 16.2.1.3.4.1	1.25 × D
Over 12 ft (3.7 m), up to and including 15 ft (4.6 m)	I	No	No	16.2.1.3.2(a)	C and D	Yes	No
		Yes		16.2.1.3.2(a)			Yes
	II	No		16.2.1.3.2(b)			No
		Yes		16.2.1.3.2(b)			Yes
	III	No	No	16.2.1.3.2(c)			No
		Yes	1 level	16.2.1.3.2(c)			Yes
	IV	No	No	16.2.1.3.2(d)			No
		Yes	1 level	16.2.1.3.2(d)			A and B
Over 15 ft (4.6 m), up to and including 20 ft (6.1 m)	I	No	No	16.2.1.3.2(a)	C and D	Yes	No
		Yes		16.2.1.3.2(a)			Yes
	II	No		16.2.1.3.2(b)			No
		Yes		16.2.1.3.2(b)			Yes
	III	No	No	16.2.1.3.2(c)			No
		Yes	1 level	16.2.1.3.2(c)			Yes
	IV	No	1 level	16.2.1.3.2(d)			No
		Yes		16.2.1.3.2(d)			A and B
Over 20 ft (6.1 m), up to and including 25 ft (7.6 m)	I	No	No	16.2.1.3.2(a)	C and D	No	No
		Yes	1 level	16.2.1.3.2(a)			Yes
	II	No	1 level	16.2.1.3.2(b)			No
		Yes		16.2.1.3.2(b)			Yes
	III	No		16.2.1.3.2(c)			No
		Yes		16.2.1.3.2(c)			Yes
	IV	No	2 levels	16.2.1.3.2(d)			No
		Yes		16.2.1.3.2(d)			A and B

NA: Not applicable.

16.2.1.3.3.2 Multiple-Row Racks — Rack Depth Over 16 ft (4.9 m) or Aisles Narrower Than 8 ft (2.4 m). For Class I, Class II, Class III, or Class IV commodities, encapsulated or nonencapsulated, ceiling sprinkler water demand in terms of density [gpm/ft² (mm/min)] and area of sprinkler operation [ft² (m²) of ceiling or roof] shall be selected from the density–area curves of Figure 16.2.1.3.2(a) through Figure 16.2.1.3.2(g) that are appropriate for each commodity and configuration as shown in Table 16.2.1.3.3.2 and shall be modified as appropriate by 16.2.1.3.4. The protection criteria shall apply to portable racks arranged in the same manner as single-, double-, or multiple-row racks.

Table 16.2.1.3.3.2 Multiple-Row Racks — Rack Depth Over 16 ft (4.9 m) or Aisles Narrower Than 8 ft (2.4 m) Up to and Including 25 ft (7.6 m)

Height	Commodity Class	Encapsulated	Sprinklers Mandatory In-Racks	Ceiling Sprinklers			
				With In-Rack Sprinklers			
				Figure	Curves	Apply Figure 16.2.1.3.4.1	1.5 Density
Over 12 ft (3.7 m), up to and including 15 ft (4.6 m)	I	No	No	16.2.1.3.2(a)	C and D	Yes	1.5 Density
		Yes		16.2.1.3.2(a)			Yes
	II	No		16.2.1.3.2(b)			1.5 Density
		Yes		16.2.1.3.2(b)			Yes
	III	No	16.2.1.3.2(c)	1.5 Density			
		Yes	16.2.1.3.2(c)	Yes			
	IV	No	No	16.2.1.3.2(d)			1.5 Density
		Yes	1 level	16.2.1.3.2(d)			1.5 Density
Over 15 ft (4.6 m), up to and including 20 ft (6.1 m)	I	No	1 level	16.2.1.3.2(a)	C and D	Yes	1.5 Density
		Yes		16.2.1.3.2(a)			Yes
	II	No		16.2.1.3.2(b)			1.5 Density
		Yes		16.2.1.3.2(b)			Yes
	III	No	16.2.1.3.2(c)	1.5 Density			
		Yes	16.2.1.3.2(c)	Yes			
	IV	No	16.2.1.3.2(d)	1.5 Density			
		Yes	16.2.1.3.2(d)	1.5 Density			
Over 20 ft (6.1 m), up to and including 25 ft (7.6 m)	I	No	1 level	16.2.1.3.2(a)	C and D	No	1.5 Density
		Yes		16.2.1.3.2(a)			Yes
	II	No		16.2.1.3.2(b)			1.5 Density
		Yes		16.2.1.3.2(b)			Yes
	III	No	16.2.1.3.2(c)	1.5 Density			
		Yes	16.2.1.3.2(c)	Yes			
	IV	No	2 levels	16.2.1.3.2(d)			1.5 Density
		Yes		16.2.1.3.2(d)			1.5 Density

16.2.1.3.4 Ceiling Sprinkler Density Adjustments.

16.2.1.3.4.1 For storage height over 12 ft (3.7 m) up to and including 25 ft (7.6 m) protected with ceiling sprinklers only and for storage height over 12 ft (3.7 m) up to and including 20 ft (6.1 m) protected with ceiling sprinklers and minimum required in-rack sprinklers, densities obtained from design curves shall be adjusted in accordance with Figure 16.2.1.3.4.1.

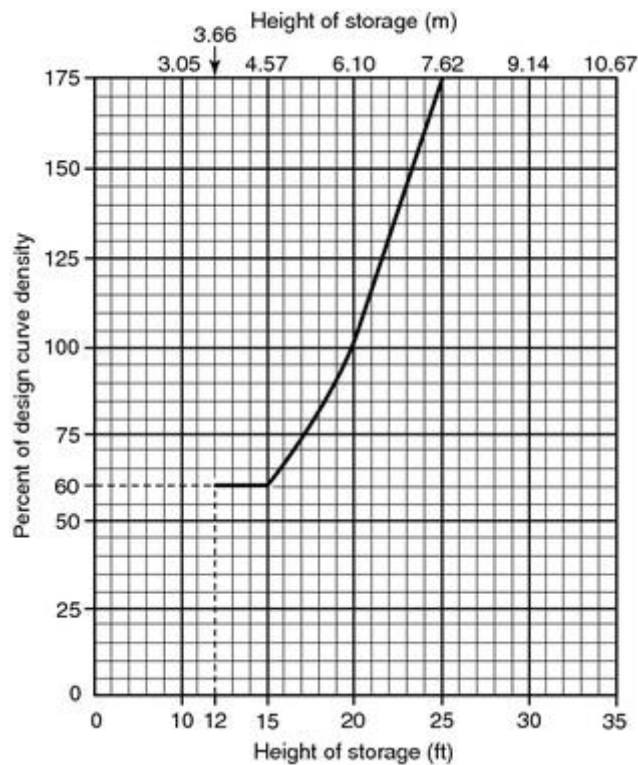

FIGURE 16.2.1.3.4.1 Ceiling Sprinkler Density vs. Storage Height.

16.2.1.3.4.2 For storage height over 20 ft (6.1 m) up to and including 25 ft (7.6 m) protected with ceiling sprinklers and minimum required in-rack sprinklers, densities obtained from design curves shall be used. Densities shall not be adjusted in accordance with Figure 16.2.1.3.4.1.

16.2.1.3.4.3 For storage height over 12 ft (3.7 m) up to and including 20 ft (6.1 m) protected with ceiling sprinklers and with more than one level of in-rack sprinklers, but not in every tier, densities obtained from design curves and adjusted in accordance with Figure 16.2.1.3.4.1 shall be permitted to be reduced an additional 20 percent, as indicated in Table 16.2.1.3.4.3.

Table 16.2.1.3.4.3 Adjustment to Ceiling Sprinkler Density for Storage

Storage Height	In-Rack Sprinklers	Ap 16. Sto A
Over 12 ft (3.7 m) through 25 ft (7.6 m)	None	

Table 16.2.1.3.4.3 Adjustment to Ceiling Sprinkler Density for Storage

Storage Height	In-Rack Sprinklers	Ap 16.2 Sto A
Over 12 ft (3.7 m) through 20 ft (6.1 m)	Minimum required	
	More than minimum, but not in every tier	
	In every tier	
Over 20 ft (6.1 m) through 24 ft (7.5 m)	Minimum required	
	More than minimum, but not in every tier	
	In every tier	

16.2.1.3.4.4 For storage height over 20 ft (6.1 m) up to and including 25 ft (7.6 m) protected with ceiling sprinklers and with more than the minimum required level of in-rack sprinklers, but not in every tier, densities obtained from design curves shall be permitted to be reduced 20 percent as indicated in Table 16.2.1.3.4.3. Densities shall not be adjusted in accordance with Figure 16.2.1.3.4.1 for storage height.

16.2.1.3.4.5 For storage height over 12 ft (3.7 m) up to and including 20 ft (6.1 m) protected with ceiling sprinklers and in-rack sprinklers at each tier, densities obtained from design curves and adjusted in accordance with Figure 16.2.1.3.4.1 shall be permitted to be reduced an additional 40 percent, as indicated in Table 16.2.1.3.4.3.

16.2.1.3.4.6 For storage height over 20 ft (6.1 m) up to and including 25 ft (7.6 m) protected with ceiling sprinklers and in-rack sprinklers at each tier, densities obtained from design curves shall be permitted to be reduced 40 percent, as indicated in Table 16.2.1.3.4.3. Densities shall not be adjusted in accordance with Figure 16.2.1.3.4.1 for storage height.

16.2.1.3.4.7 Where solid, flat-bottom, combustible pallets (slave pallets) are used with storage height up to and including 25 ft (7.6 m), the densities that are indicated in the design curves shown in Figure 16.2.1.3.2(a) through Figure 16.2.1.3.2(g), based on conventional pallets, shall be increased 20 percent for the given area. The percentage shall be applied to the density determined in accordance with Figure 16.2.1.3.4.1. The increase in density shall not apply where in-rack sprinklers are installed in accordance with Table 16.2.1.3.4.3.

16.2.1.3.5* The minimum water supply requirements for a hydraulically designed occupancy hazard fire control sprinkler system shall be determined by adding the hose stream allowance from Table 16.2.1.3.5 to the water supply for sprinklers determined in 16.2.1.3. This supply

shall be increased 20 percent for the given area. The percentage shall be applied to the density determined in accordance with Figure 16.2.1.3.4.1. The increase in density shall not apply where in-rack sprinklers are installed in accordance with Table 16.2.1.3.4.3.

16.2.1.3.5* The minimum water supply requirements for a hydraulically designed occupancy hazard fire control sprinkler system shall be determined by adding the hose stream allowance from Table 16.2.1.3.5 to the water supply for sprinklers determined in 16.2.1.3. This supply shall be available for the minimum duration specified in Table 16.2.1.3.5. *(See Section C.8.)*

Table 16.2.1.3.5 Hose Stream Allowance and Water Supply Duration Requirements for Class IV Commodities Stored Up to and Including 25 ft (7.6 m) i

Commodity Classification	Storage Height		Inside Hose		Total
	ft	m	gpm	L/min	g
Class I, II, and III	Over 12	Over 3.7	0, 50, or 100	0, 190, 380	5
Class IV	Over 12	Over 3.7	0, 50, or 100	0, 190, 380	5

16.2.2 Large Drop Sprinklers and Specific Application Control Mode Sprinklers for Rack Storage of Class I Through Class IV Commodities Stored Up to and Including 25 ft (7.6 m) in Height.

16.2.2.1 Protection of single-, double-, and multiple-row rack storage without solid shelves for Class I through Class IV commodities shall be in accordance with Table 16.2.2.1(a) or Table 16.2.2.1(b).

Table 16.2.2.1(a) Large Drop Sprinkler Design Criteria for Single-, Double-, and Multiple-Row Rack Storage of Class I Through Class IV Commodities Stored Up to and Including 25 ft (7.6 m) in Height

Commodity Class	Nominal K-Factor	Maximum Storage Height		Maximum Ceiling/Roof Height		Type of System	S _i
		ft	m	ft	m		
I, II	11.2 (161)	25	7.6	30	9.1	Wet	
						Dry	
I, II, III	11.2 (161)	20	6.1	30	9.1	Wet	
						Dry	
I, II, III	11.2 (161)	25	7.6	35	10.7	Wet	1.
						Dry	2.
IV	11.2 (161)	20	6.1	25	7.6	Wet	
						Dry	
IV	11.2 (161)	20	6.1	30	9.1	Wet	
						Dry	
IV	11.2 (161)	20	6.1	30	9.1	Wet	
						Dry	
IV	11.2 (161)	25	7.6	30	9.1	Wet	1.
						Dry	
IV	11.2 (161)	25	7.6	35	10.7	Wet	2.
						Dry	
IV	11.2 (161)	25	7.6	35	10.7	Wet	1.
						Dry	

NA: Not applicable.

Table 16.2.2.1(b) Specific Application Control Mode [16.8 K-factor (242)] Sprinkler Des Racks Without Solid Shelves of Class I Through Class IV Commodities Stored 1

Commodity Class	Maximum Storage Height		Maximum Building Height		Type of System	Number of I by Minim Pr
	ft	m	ft	m		10 psi 0.7 ba
I or II	25	7.6	30	9.1	Wet	15
III or IV	25	7.6	30	9.1	Wet	—

16.2.2.2 Where in-rack sprinklers are required by Table 16.2.2.1(a) and Table 16.2.2.1(b), in-rack sprinkler spacing, design pressure, and hydraulic calculation criteria shall be in accordance with the requirements of 16.2.4 as applicable for the commodity.

16.2.2.3 Protection shall be provided as specified in Table 16.2.2.1(a) and Table 16.2.2.1(b) or appropriate NFPA standards in terms of minimum operating pressure and the number of sprinklers to be included in the design area.

16.2.2.4 Open Wood Joist Construction.

16.2.2.4.1 Where large drop K-11.2 sprinklers are installed under open wood joist construction, their minimum operating pressure shall be 50 psi (3.4 bar).

16.2.2.4.2 Where each joist channel of open, wood joist construction is fully firestopped to its full depth at intervals not exceeding 20 ft (6.1 m), the lower pressures specified in Table 16.2.2.1(a) shall be permitted to be used.

16.2.2.5 The design area shall be a rectangular area having a dimension parallel to the branch lines at least 1.2 times the square root of the area protected by the number of sprinklers to be included in the design area. Any fractional sprinkler shall be included in the design area.

16.2.2.6 Hose stream allowance and water supply duration requirements shall be in accordance with Table 16.2.2.1(a) and Table 16.2.2.1(b).

16.2.2.7 Preaction Systems.

16.2.2.7.1 For the purpose of using Table 16.2.2.1(a) and Table 16.2.2.1(b), preaction systems shall be classified as dry pipe systems.

16.2.2.8 Building steel shall not require special protection where Table 16.2.2.1(a) or Table 16.2.2.1(b) is applied as appropriate for the storage configuration.

16.2.3* Early Suppression Fast-Response (ESFR) Sprinklers for Rack Storage of Class

I Through Class IV Commodities Stored Up to and Including 25 ft (7.6 m) in Height.

16.2.3.1 Protection of single-, double-, and multiple-row rack storage of Class I through Class IV shall be in accordance with Table 16.2.3.1.

Table 16.2.3.1 ESFR Protection of Rack Storage Without Solid Shelves of Class I Through Class IV Including 25 ft (7.6 m) in Height

Storage Arrangement	Commodity	Maximum Storage Height		Maximum Ceiling/ Roof Height		Nominal K-Factor	Orientation	Minimum Operating Pressure	
		ft	m	ft	m			psi	

**Table 16.2.3.1 ESFR Protection of Rack Storage Without Solid Shelves of Class I Thru
Including 25 ft (7.6 m) in Height**

Storage Arrangement	Commodity	Maximum Storage Height		Maximum Ceiling/ Roof Height		Nominal K-Factor	Orientation	Minimum Operating Pressure	
		ft	m	ft	m			psi	
						14.0 (201)	Upright or pendent	50	

**Table 16.2.3.1 ESFR Protection of Rack Storage Without Solid Shelves of Class I Thru
Including 25 ft (7.6 m) in Height**

Storage Arrangement	Commodity	Maximum Storage Height		Maximum Ceiling/ Roof Height		Nominal K-Factor	Orientation	Minimum Operating Pressure	
		ft	m	ft	m			psi	
				25	7.6	16.8 (242)	Upright/ Pendent	35	
						22.4 (322)	Pendent	25	
						25.2 (363)	Pendent	15	
				30	9.1	14.0 (201)	Upright or pendent	50	
						16.8 (242)	Upright/ Pendent	35	
						22.4 (322)	Pendent	25	

**Table 16.2.3.1 ESFR Protection of Rack Storage Without Solid Shelves of Class I Thru
Including 25 ft (7.6 m) in Height**

Storage Arrangement	Commodity	Maximum Storage Height		Maximum Ceiling/ Roof Height		Nominal K-Factor	Orientation	Minimum Operating Pressure	
		ft	m	ft	m			psi	
		20	6.1			22.4 (322)	Pendent	25	
						25.2 (363)	Pendent	15	
						35	10.7	14.0 (201)	Upright or pendent
				16.8 (242)	Upright/ Pendent			52	
				22.4 (322)	Pendent			35	
				25.2	Pendent			20	

Table 16.2.3.1 ESFR Protection of Rack Storage Without Solid Shelves of Class I Through Class III Including 25 ft (7.6 m) in Height

Storage Arrangement	Commodity	Maximum Storage Height		Maximum Ceiling/ Roof Height		Nominal K-Factor (363)	Orientation	Minimum Operating Pressure	
		ft	m	ft	m			psi	

Table 16.2.3.1 ESFR Protection of Rack Storage Without Solid Shelves of Class I Through IV Including 25 ft (7.6 m) in Height

Storage Arrangement	Commodity	Maximum Storage Height		Maximum Ceiling/ Roof Height		Nominal K-Factor	Orientation	Minimum Operating Pressure			
		ft	m	ft	m			psi			
Single-row, double-row, and multiple-row rack (no open-top containers)	Class I, II, III, or IV, encapsulated or unencapsulated			40	12.2	14.0 (201)	Pendent	75			
						16.8 (242)	Pendent	52			
						22.4 (322)	Pendent	40			
						25.2 (363)	Pendent	25			
				45	13.7	14.0 (201)	Pendent	90			
						16.8 (242)	Pendent	63			
						22.4 (322)	Pendent	40			
						25.2 (363)	Pendent	40			
						30	9.1	14.0 (201)	Upright or pendent	50	
								16.8 (242)	Upright/ Pendent	35	
								22.4 (322)	Pendent	25	
								25.2 (363)	Pendent	15	
		32	9.8			14.0 (201)	Upright or pendent	60			
						16.8 (242)	Upright/ Pendent	42			
		35	10.7			14.0 (201)	Upright or pendent	75			
						16.8 (242)	Upright/ Pendent	52			
22.4 (322)	Pendent			35							

Table 16.2.3.1 ESFR Protection of Rack Storage Without Solid Shelves of Class I Thru Including 25 ft (7.6 m) in Height

Storage Arrangement	Commodity	Maximum Storage Height		Maximum Ceiling/ Roof Height		Nominal K-Factor	Orientation	Minimum Operating Pressure	
		ft	m	ft	m			psi	
		25	7.6			25.2 (363)	Pendent	20	
				40	12.2	14.0 (201)	Pendent	75	
						16.8 (242)	Pendent	52	
						22.4 (322)	Pendent	40	
						25.2 (363)	Pendent	25	
				45	13.7	14.0 (201)	Pendent	90	
						16.8 (242)	Pendent	63	
						22.4 (322)	Pendent	40	
						25.2 (363)	Pendent	40	

16.2.3.2 ESFR protection as defined shall not apply to the following:

- (1) Rack storage involving solid shelves
- (2) Rack storage involving combustible, open-top cartons or containers

16.2.3.3 ESFR sprinkler systems shall be designed such that the minimum operating pressure is not less than that indicated in Table 16.2.3.1 for type of storage, commodity, storage height, and building height involved.

16.2.3.4 The design area shall consist of the most hydraulically demanding area of 12 sprinklers, consisting of four sprinklers on each of three branch lines.

16.2.3.5 Where ESFR sprinklers are installed above and below obstructions, the discharge for up to two sprinklers for one of the levels shall be included with those of the other level in the hydraulic calculations.

16.2.4 In-Rack Sprinklers for Rack Storage of Class I Through Class IV Commodities Stored Up to and Including 25 ft (7.6 m) in Height.

16.2.4.1 In-Rack Sprinkler Location for Rack Storage of Class I Through Class IV Commodities Stored Up to and Including 25 ft (7.6 m) in Height.

16.2.4.1.1 In single- or double-row racks without solid shelves, in-rack sprinklers shall be installed in accordance with Table 16.2.1.3.2.

16.2.4.1.2 In multiple-row racks no deeper than 16 ft (4.9 m) with aisles 8 ft (2.4 m) or wider, in-rack sprinklers shall be installed in accordance with Table 16.2.1.3.3.1.

16.2.4.1.3 In multiple-row racks deeper than 16 ft (4.9 m) or with aisles less than 8 ft (2.4 m) wide, in-rack sprinklers shall be installed in accordance with Table 16.2.1.3.3.2.

16.2.4.1.4 In-rack sprinklers at one level only for storage up to and including 25 ft (7.6 m) high shall be located at the first tier level at or above one-half of the storage height.

16.2.4.1.5 In-rack sprinklers at two levels only for storage up to and including 25 ft (7.6 m) high shall be located at the first tier level at or above one-third and two-thirds of the storage height.

16.2.4.2 In-Rack Sprinkler Spacing for Rack Storage of Class I Through Class IV Commodities Stored Up to and Including 25 ft (7.6 m) in Height.

16.2.4.2.1* Maximum horizontal spacing of in-rack sprinklers in single- or double-row racks with nonencapsulated storage up to and including 25 ft (7.6 m) in height shall be in accordance with Table 16.2.4.2.1. For encapsulated storage, maximum horizontal spacing shall be 8 ft (2.4 m).

Table 16.2.4.2.1 In-Rack Sprinkler Spacing for Class I, II, III, and IV Commodities Stored Up to and Including 25 ft (7.6 m) in Height

Aisle Widths		Commodity Class					
		I and II		III		IV	
ft	m	ft	m	ft	m	ft	
8	2.4	12	3.7	12	3.7	8	
4	1.2	12	3.7	8	2.4	8	

16.2.4.2.2* Maximum horizontal spacing of in-rack sprinklers on branch lines, in multiple-row racks with encapsulated or nonencapsulated storage up to and including 25 ft (7.6 m) in height, shall not exceed 12 ft (3.7 m) for Class I, II, or III commodities and 8 ft (2.4 m) for Class IV commodities, with area limitations of 100 ft² (9.3 m²) per sprinkler for Class I, II, or III commodities and 80 ft² (7.4 m²) per sprinkler for Class IV commodities. The rack plan view shall be considered in determining the area covered by each sprinkler. The aisles shall not be included in area calculations.

16.2.4.2.3* The elevation of in-rack sprinkler deflectors with respect to storage shall not be a consideration in single- or double-row rack storage up to and including 20 ft (6.1 m) high. (See Section C.16.)

16.2.4.2.4* In single- or double-row racks without solid shelves with storage over 20 ft (6.1

m) high, or in multiple-row racks, or in single- or double-row racks with solid shelves and storage height up to and including 25 ft (7.6 m), a minimum of 6 in. (152.4 mm) vertical clear space shall be maintained between the in-rack sprinkler deflectors and the top of a tier of storage. Sprinkler discharge shall not be obstructed by horizontal rack members.

16.2.4.2.5 For multiple-row racks, a minimum of 6 in. (152.4 mm) shall be maintained between the in-rack sprinkler deflector and the top of a tier of storage.

16.2.4.2.6 Sprinklers installed in racks shall be spaced without regard to rack uprights. (*See Section C.17.*)

16.2.4.3 In-Rack Sprinkler Water Demand for Rack Storage of Class I Through Class IV Commodities Stored Up to and Including 25 ft (7.6 m) in Height. (*See Section C.18.*)

16.2.4.3.1 The water demand for sprinklers installed in racks shall be based on simultaneous operation of the most hydraulically remote sprinklers as follows:

- (1) Six sprinklers where only one level is installed in racks with Class I, Class II, or Class III commodities
- (2) Eight sprinklers where only one level is installed in racks with Class IV commodities
- (3) Ten sprinklers (five on each two top levels) where more than one level is installed in racks with Class I, Class II, or Class III commodities
- (4) Fourteen sprinklers (seven on each two top levels) where more than one level is installed in racks with Class IV commodities

16.2.4.3.2 Where a storage rack, due to its length, requires less than the number of in-rack sprinklers specified in 16.2.4.3.1(1) through 16.2.4.3.1(4), only those in-rack sprinklers in a single rack need to be included in the calculation.

16.2.4.4 In-Rack Sprinkler Discharge Pressure for Rack Storage of Class I Through Class IV Commodities Stored Up to and Including 25 ft (7.6 m) in Height. Sprinklers in racks shall discharge at not less than 15 psi (1 bar) for all classes of commodities. (*See Section C.19.*)

16.2.5 Special Design for Rack Storage of Class I Through Class IV Commodities Stored Up to and Including 25 ft (7.6 m) in Height.

16.2.5.1 Slatted Shelves.

16.2.5.1.1* Slatted rack shelves shall be considered equivalent to solid rack shelves where the shelving is not considered open rack shelving or where the requirements of 16.2.5.1.2 are not met. (*See Section C.20.*)

16.2.5.1.2 A wet pipe system that is designed to provide a minimum of 0.6 gpm/ft² (24.5 mm/min) density over a minimum area of 2000 ft² (186 m²) or K-14.0 (201) ESFR sprinklers operating at a minimum of 50 psi (3.5 bar), K-16.8 (242) sprinklers operating at a minimum of 32 psi (1.7 bar), or K-25.2 (363) ESFR sprinklers operating at a minimum of 15 psi (1 bar) shall be permitted to protect single-row and double-row racks with slatted rack shelving racks where all of the following conditions are met:

- (1) Sprinklers shall be K-11.2 (161), K-14.0 (201), or K-16.8 (242) orifice spray sprinklers with a temperature rating of ordinary, intermediate, or high and shall be listed for storage occupancies or shall be K-14.0 (201), K-16.8 (242), or K-25.2 (363) ESFR.
- (2) The protected commodities shall be limited to Class I-IV, Group B plastics, Group C plastics, cartoned (expanded and unexpanded) Group A plastics, and exposed (unexpanded) Group A plastics.
- (3) Slats in slatted rack shelving shall be a minimum nominal 2 in. (38 mm) thick by maximum nominal 6 in. (140 mm) wide with the slats held in place by spacers that maintain a minimum 2 in. (51 mm) opening between each slat.
- (4) Where K-11.2 (161), K-14.0 (201), or K-16.8 (242) orifice sprinklers are used, there shall be no slatted shelf levels in the rack above 12 ft (3.7 m). Open rack shelving using wire mesh shall be permitted for shelf levels above 12 ft (3.7 m).
- (5) Transverse flue spaces at least 3 in. (76 mm) wide shall be provided at least every 10 ft (3.1 m) horizontally.
- (6) Longitudinal flue spaces at least 6 in. (152 mm) wide shall be provided for double-row racks. Longitudinal flue spaces shall not be required where ESFR sprinklers are used.
- (7) The aisle widths shall be at least 7½ ft (2.5 m).
- (8) The maximum roof height shall be 27 ft (8.2 m) or 30 ft where ESFR sprinklers are used.
- (9) The maximum storage height shall be 20 ft (6.1 m).
- (10) Solid plywood or similar materials shall not be placed on the slatted shelves so that they block the 2 in. (51 mm) spaces between slats, nor shall they be placed on the wire mesh shelves.

16.3 Protection Criteria for Rack Storage of Class I Through Class IV Commodities Stored Over 25 ft (7.6 m) in Height.

16.3.1 Control Mode Density–Area Sprinkler Protection Criteria for Rack Storage of Class I Through Class IV Commodities Stored Over 25 ft (7.6 m) in Height.

16.3.1.1* For single- and double-row racks, the water demand for nonencapsulated storage without solid shelves separated by aisles at least 4 ft (1.2 m) wide and with not more than 10 ft (3.1 m) between the top of storage and the sprinklers shall be based on sprinklers in a 2000 ft² (186 m²) operating area, discharging a minimum of 0.25 gpm/ft² (10.2 mm/min) for Class I commodities, 0.3 gpm/ft² (12.2 mm/min) for Classes II and III commodities, and 0.35 gpm/ft² (14.3 mm/min) for Class IV commodities for ordinary temperature–rated sprinklers or a minimum of 0.35 gpm/ft² (14.3 mm/min) for Class I commodities, 0.4 gpm/ft² (16.3 mm/min) for Classes II and III commodities, and 0.45 gpm/ft² (18.3 mm/min) for Class IV

Stored Over 25 ft (7.6 m) in Height.

16.3.1 Control Mode Density–Area Sprinkler Protection Criteria for Rack Storage of Class I Through Class IV Commodities Stored Over 25 ft (7.6 m) in Height.

16.3.1.1* For single- and double-row racks, the water demand for nonencapsulated storage without solid shelves separated by aisles at least 4 ft (1.2 m) wide and with not more than 10 ft (3.1 m) between the top of storage and the sprinklers shall be based on sprinklers in a 2000 ft² (186 m²) operating area, discharging a minimum of 0.25 gpm/ft² (10.2 mm/min) for Class I commodities, 0.3 gpm/ft² (12.2 mm/min) for Classes II and III commodities, and 0.35 gpm/ft² (14.3 mm/min) for Class IV commodities for ordinary temperature–rated sprinklers or a minimum of 0.35 gpm/ft² (14.3 mm/min) for Class I commodities, 0.4 gpm/ft² (16.3 mm/min) for Classes II and III commodities, and 0.45 gpm/ft² (18.3 mm/min) for Class IV commodities for high temperature–rated sprinklers. (See Table 16.3.1.1 and Section C.23.)

Table 16.3.1.1 Double-Row Racks Without Solid Shelves, of Class I Through Class IV C Aisles 4 ft (1.2 m) or Wider

Commodity Class	In-Rack Sprinklers Approximate Vertical Spacing at Tier Nearest the Vertical Distance and Maximum Horizontal Spacing ^{a,b,c}		Figure	Maximum Storage Height	Stagger	O ₁
	Longitudinal Flue ^d	Face ^{e,f}				
I	Vertical 20 ft (6.1 m) Horizontal 10 ft (3.1 m) under horizontal barriers	None	16.3.4.1.1(a)	30 ft (9.1 m)	No	2
	Vertical 20 ft (6.1 m) Horizontal 10 ft (3.1 m)	Vertical 20 ft (6.1 m) Horizontal 10 ft (3.1 m)	16.3.4.1.1(b)	Higher than 25 ft (7.6 m)	Yes	

**Table 16.3.1.1 Double-Row Racks Without Solid Shelves, of Class I Through Class IV C
Aisles 4 ft (1.2 m) or Wider**

Commodity Class	In-Rack Sprinklers Approximate Vertical Spacing at Tier Nearest the Vertical Distance and Maximum Horizontal Spacing ^{a,b,c}		Figure	Maximum Storage Height	Stagger	O ₁
	Longitudinal Flue ^d	Face ^{e,f}				
		ft (1.5 m)				
	Horizontal barriers at 20 ft (6.1 m) Vertical intervals — two lines of sprinklers under barriers — maximum horizontal spacing 10 ft (3.1 m), staggered		16.3.4.1.1(g)		Yes	
I, II, III, IV	Vertical 15 ft (4.6 m) Horizontal 10 ft (3.1 m)	Vertical 20 ft (6.1 m) Horizontal 10 ft (3.1 m)	16.3.4.1.1(h)	Higher than 25 ft (7.6 m)	Yes	20 ^l
	Vertical 20 ft (6.1 m) Horizontal 5 ft (1.5 m)	Vertical 20 ft (6.1 m) Horizontal 5 ft (1.5 m)	16.3.4.1.1(i)		No	
	Horizontal barriers at 15 ft (4.6 m) Vertical intervals — two lines of sprinklers under barriers — maximum horizontal spacing 10 ft (3.1 m), staggered		16.3.4.1.1(j)		Yes	

^aMinimum in-rack sprinkler discharge, 30 gpm (114 L/min).

^bWater shields required.

^cAll in-rack sprinkler spacing dimensions start from the floor.

^dInstall sprinklers at least 3 in. (76.2 mm) from uprights.

^eFace sprinklers shall not be required for a Class I commodity consisting of noncombustible products on wood shown in Figure 16.3.4.1.1(g) and Figure 16.3.4.1.1(j).

^fIn Figure 16.3.4.1.1(a) through Figure 16.3.4.1.1(j), each square represents a storage cube that measures 4 ft by 4 ft by 4 ft. In Figure 16.3.4.1.1(a) through Figure 16.3.4.1.1(j), each square represents a storage cube that measures 4 ft by 4 ft by 4 ft. Therefore, there can be one load to six or seven loads apart vertically.

^gFor encapsulated commodity, increase density 25 percent.

^hClearance is distance between top of storage and ceiling.

ⁱSee A.16.1.9 for protection recommendations where clearance is greater than 10 ft (3.1 m).

16.3.1.1.1 Where storage as described in 16.3.1.1 is encapsulated, ceiling sprinkler density shall be 25 percent greater than for nonencapsulated storage.

16.3.1.2 For multiple-row racks, the water demand for nonencapsulated storage without

solid shelves separated by aisles at least 4 ft (1.2 m) wide and with not more than 10 ft (3.1 m) between the top of storage and the sprinklers shall be based on sprinklers in a 2000 ft² (186 m²) operating area for multiple-row racks, discharging a minimum of 0.25 gpm/ft² (10.2 mm/min) for Class I commodities, 0.3 gpm/ft² (12.2 mm/min) for Classes II and III commodities, and 0.35 gpm/ft² (14.3 mm/min) for Class IV commodities for ordinary temperature-rated sprinklers or a minimum of 0.35 gpm/ft² (14.3 mm/min) for Class I commodities, 0.4 gpm/ft² (16.3 mm/min) for Classes II and III commodities, and 0.45 gpm/ft² (18.3 mm/min) for Class IV commodities for high temperature-rated sprinklers. (See Table 16.3.1.2.)

Table 16.3.1.2 Multiple-Row Racks, of Class I Through Class IV Comm

Commodity Class	Encapsulated	In-Rack Sprinklers ^{a,b,c}						Height Limit (ft)	Stagger	Figure	Storage
		Approximate Vertical Spacing		Maximum Horizontal Spacing in A Flue		Maximum Horizontal Spacing across Flue					
		ft	m	ft	m	ft	m				
I	No	20	6.1	12	3.7	10	3.1	None	Between adjacent flues	16.3.4.1.3(a)	
	Yes										
I, II, and III	No	15	4.6	10	3.1	10	3.1				
	Yes										
I, II, III, and IV	No	10	3.1	10	3.1	10	3.1				
	Yes										

For SI units, °C = $\frac{5}{9}$ (°F-32); 1 gpm/ft² = 40.746 mm/min.

^aAll four rack faces shall be protected by sprinklers located within 18 in. (0.46 m) of the faces, as indicated in required for each sprinkler level to protect all faces.

^bAll in-rack sprinkler spacing dimensions start from the floor.

^cIn Figure 16.3.4.1.3(a) through Figure 16.3.4.1.3(c), each square represents a storage cube measuring 4 ft to approximately 18 in. to 10 ft (0.46 m to 3.1 m). Therefore, there could be as few as one load or as many as six apart vertically.

16.3.1.2.1 Where such storage is encapsulated, ceiling sprinkler density shall be 25 percent greater than for nonencapsulated storage.

16.3.1.3 The minimum water supply requirements for a hydraulically designed occupancy hazard fire control sprinkler system shall be determined by adding the hose stream allowance from Table 16.3.1.3 to the water supply for sprinklers determined in Section 16.3. This supply shall be available for the minimum duration specified in Table 16.3.1.3.

Table 16.3.1.3 Hose Stream Allowance and Water Supply Duration Requirements for Commodities Stored Above 25 ft (7.6 m) in H

16.3.1.3 The minimum water supply requirements for a hydraulically designed occupancy hazard fire control sprinkler system shall be determined by adding the hose stream allowance from Table 16.3.1.3 to the water supply for sprinklers determined in Section 16.3. This supply shall be available for the minimum duration specified in Table 16.3.1.3.

Table 16.3.1.3 Hose Stream Allowance and Water Supply Duration Requirements for Commodities Stored Above 25 ft (7.6 m) in Height

Commodity Classification	Storage Height		Inside Hose	
	ft	m	gpm	L/min
Class I, II, and III	>25	>7.6	0, 50, or 100	0, 190, 380
Class IV	>25	>7.6	0, 50, or 100	0, 190, 380

16.3.2 Large Drop Sprinklers and Specific Application Control Mode Sprinklers for Rack Storage of Class I Through Class IV Commodities Stored Over 25 ft (7.6 m) in Height.

16.3.2.1 Protection of single-, double-, and multiple-row rack storage without solid shelves for Class I through Class IV commodities shall be in accordance with Table 16.3.2.1(a) and Table 16.3.2.1(b).

Table 16.3.2.1(a) Large Drop Sprinkler Design Criteria for Single-, Double-, and Multiple-Row Rack Storage of Class I Through Class IV Commodities Stored Over 25 ft (7.6 m) in Height

Commodity Class	Nominal K-Factor	Maximum Storage Height		Maximum Ceiling/ Roof Height		Type of System	Number of Design Minimum Flow	
		ft	m	ft	m		#/psi	
I, II	11.2 (161)	30	9.1	35	10.7	Wet	20/25 + 1 level of in-rack	
						Dry	30/25 + 1 level of in-rack	
I, II	11.2 (161)	35	10.7	40	12.2	Dry*	36/55	
III, IV	Design criteria not applicable to Class III or Class IV commodities stored over 25 ft (7.6 m) in height.							

*High temperature rated sprinklers shall be used. Dry system water delivery shall be determined in accordance with NFPA 13, 2007 Edition, Section 16.3.2.1(b) and 16.3.2.1(c).

Table 16.3.2.1(b) Specific Application Control Mode [16.8 K-factor (242)] Sprinkler Design Criteria for Multiple-Row Racks Without Solid Shelves of Class I Through Class IV Commodities Stored Over 25 ft (7.6 m) in Height

Commodity Class	Nominal K-Factor	Maximum Storage Height	Maximum Ceiling/ Roof Height	Type of System	Number of Design Minimum Flow
-----------------	------------------	------------------------	------------------------------	----------------	-------------------------------

Commodity Class	Nominal K-Factor	ft	m	ft	m	System	#/psi
-----------------	------------------	----	---	----	---	--------	-------

Table 16.3.2.1(b) Specific Application Control Mode [16.8 K-factor (242)] Sprink Multiple-Row Racks Without Solid Shelves of Class I Through Class IV Comm

Commodity Class	Nominal K-Factor	Maximum Storage Height		Maximum Ceiling/ Roof Height		Type of System	Number of Desig
		ft	m	ft	m		Minimum F
I, II	16.8 (242)	35	10.7	40	12.2	Dry*	#/psi 36/22
III, IV	Design criteria not applicable to Class III or Class IV commodities st						

*High temperature rated sprinklers shall be used. Dry system water delivery shall be determined in accordance seconds with four sprinklers initially open.

16.3.2.2 Where in-rack sprinklers are required by Table 16.3.2.1(a), in-rack sprinkler spacing, design pressure, and hydraulic calculation criteria shall be in accordance with the requirements of 16.3.4 as applicable for the commodity.

16.3.2.3 Protection shall be provided as specified in Table 16.3.2.1(a) or appropriate NFPA standards in terms of minimum operating pressure and the number of sprinklers to be included in the design area.

16.3.2.4 Open Wood Joist Construction.

16.3.2.4.1 Where large drop K-11.2 (161) sprinklers are installed under open wood joist construction, their minimum operating pressure shall be 50 psi (3.4 bar).

16.3.2.4.2 Where each joist channel of open, wood joist construction is fully fire-stopped to its full depth at intervals not exceeding 20 ft (6.1 m), the lower pressures specified in Table 16.3.2.1(a) shall be permitted to be used.

16.3.2.5 The design area shall be a rectangular area having a dimension parallel to the branch lines at least 1.2 times the square root of the area protected by the number of sprinklers to be included in the design area. Any fractional sprinkler shall be included in the design area.

16.3.2.6 Hose stream allowance and water supply duration requirements shall be in accordance with Table 16.3.2.1(a) and Table 16.3.2.1(b).

16.3.2.7 Preaction Systems.

16.3.2.7.1 For the purpose of using Table 16.3.2.1(a) and Table 16.3.2.1(b), preaction systems shall be classified as dry pipe systems.

16.3.2.8 Building steel shall not require special protection where Table 16.3.2.1(a) and Table 16.3.2.1(b) are applied as appropriate for the storage configuration.

16.3.3* Early Suppression Fast-Response (ESFR) Sprinklers for Rack Storage of Class I Through Class IV Commodities Stored Over 25 ft (7.6 m) in Height.

16.3.3.1 Protection of single-, double-, and multiple-row rack storage of Class I through Class IV shall be in accordance with Table 16.3.3.1.

Table 16.3.3.1 ESFR Protection of Rack Storage Without Solid Shelves of Class I Through Class IV Commodities Stored Over 25 ft (7.6 m) in Height

Storage Arrangement	Commodity	Maximum Storage Height		Maximum Ceiling/ Roof Height		Nominal K-Factor	Orientation	M O I	
		ft	m	ft	m			ps	

Table 16.3.3.1 ESFR Protection of Rack Storage Without Solid Shelves of Class I Through III in Height

Storage Arrangement	Commodity	Maximum Storage Height		Maximum Ceiling/ Roof Height		Nominal K-Factor	Orientation	M O I ps
		ft	m	ft	m			
		30	9.1	35	10.7	14.0 (201)	Upright or pendent	75
						16.8 (242)	Upright/ Pendent	52
						22.4 (322)	Pendent	35
						25.2 (363)	Pendent	20
				40	12.2	14.0 (201)	Pendent	75
						16.8 (242)	Pendent	52
						22.4 (322)	Pendent	40
						25.2 (363)	Pendent	25
						14.0	Pendent	00

Table 16.3.3.1 ESFR Protection of Rack Storage Without Solid Shelves of Class I Through IV in Height

Storage Arrangement	Commodity	Maximum Storage Height		Maximum Ceiling/ Roof Height		Nominal K-Factor	Orientation	M O I		
		ft	m	ft	m				ps	
Single-row, double-row, and multiple-row rack (no open-top containers)	Class I, II, III, or IV, encapsulated or unencapsulated	45	13.7	45	13.7	14.0 (201)	Pendent	63		
						16.8 (242)	Pendent	63		
						22.4 (322)	Pendent	40		
						25.2 (363)	Pendent	40		
		35	10.7	40	12.2	40	12.2	14.0 (201)	Pendent	75
								16.8 (242)	Pendent	52
								22.4 (322)	Pendent	40
								25.2 (363)	Pendent	25
		45	13.7	45	13.7	45	13.7	14.0 (201)	Pendent	90
								16.8 (242)	Pendent	63
								22.4 (322)	Pendent	40
								25.2 (363)	Pendent	40
		40	12.2	45	13.7	45	13.7	14.0 (201)	Pendent	90
								16.8 (242)	Pendent	63
								22.4 (322)	Pendent	40
								25.2 (363)	Pendent	40

16.3.3.2 ESFR protection as defined shall not apply to the following:

- (1) Rack storage involving solid shelves
- (2) Rack storage involving combustible, open-top cartons or containers

16.3.3.3 ESFR sprinkler systems shall be designed such that the minimum operating

pressure is not less than that indicated in Table 16.3.3.1 for type of storage, commodity, storage height, and building height involved.

16.3.3.4 The design area shall consist of the most hydraulically demanding area of 12 sprinklers, consisting of four sprinklers on each of three branch lines.

16.3.3.5 Where required by Table 16.3.3.1, one level of K-8.0 (115) quick-response, ordinary-temperature in-rack sprinklers shall be installed at the tier level closest to but not exceeding $\frac{1}{2}$ of the maximum storage height. In-rack sprinkler hydraulic design criteria shall be the most hydraulically remote eight sprinklers at 50 psi (3.4 bar). In-rack sprinklers shall be located at the intersection of the longitudinal and transverse flue space. Horizontal spacing shall not be permitted to exceed 5 ft (1.5 m) intervals.

16.3.3.6 Where ESFR sprinklers are installed above and below obstructions, the discharge for up to two sprinklers for one of the levels shall be included with those of the other level in the hydraulic calculations.

16.3.4 In-Rack Sprinklers for Rack Storage of Class I Through Class IV Commodities Stored Over 25 ft (7.6 m) in Height.

16.3.4.1 In-Rack Sprinkler Location for Rack Storage of Class I Through Class IV Commodities Stored Over 25 ft (7.6 m) in Height.

16.3.4.1.1* Double-Row Racks.

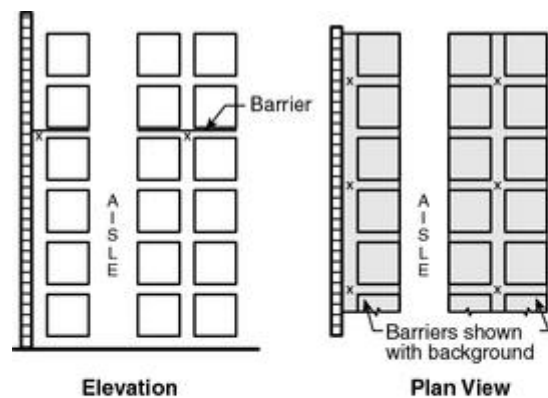

Notes:

1. Symbol x indicates in-rack sprinklers.
2. Each square represents a storage cube measuring 4 ft to 5 ft (1.22 m to 1.53 m) on a side. Actual load heights can vary from approximately 18 in. (0.46 m) up to 10 ft (3.05 m). Therefore, there could be as few as one load or as many as six or seven loads between in-rack sprinklers that are spaced 10 ft (3.05 m) apart vertically.

FIGURE 16.3.4.1.1(a) In-Rack Sprinkler Arrangement, Class I Commodities, Storage Height 25 ft to Maximum 30 ft (7.6 m to Maximum 9.1 m).

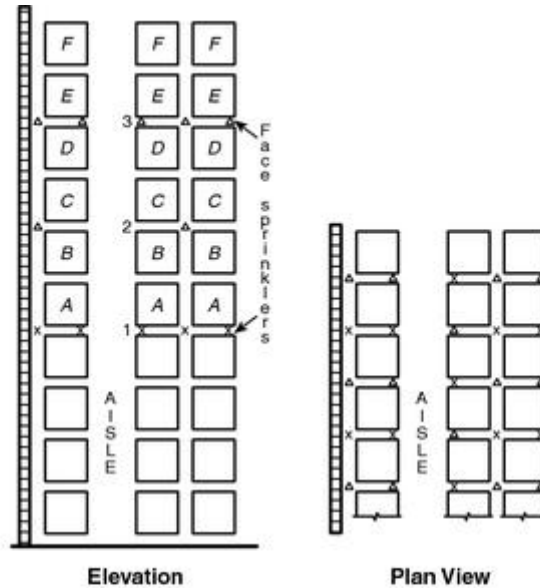

Notes:

1. Sprinklers labeled 1 (the selected array from Table 16.3.1.1) shall be required where loads labeled *A* or *B* represent top of storage.
2. Sprinklers labeled 1 and 2 shall be required where loads labeled *C* or *D* represent top of storage.
3. Sprinklers labeled 1 and 3 shall be required where loads labeled *E* or *F* represent top of storage.
4. For storage higher than represented by loads labeled *F*, the cycle defined by Notes 2 and 3 is repeated, with stagger as indicated.
5. Symbol Δ or x indicates sprinklers on vertical or horizontal stagger.
6. Each square represents a storage cube measuring 4 ft to 5 ft (1.22 m to 1.53 m) on a side. Actual load heights can vary from approximately 18 in. (0.46 m) up to 10 ft (3.05 m). Therefore, there could be as few as one load or as many as six or seven loads between in-rack sprinklers that are spaced 10 ft (3.05 m) apart vertically.

FIGURE 16.3.4.1.1(b) In-Rack Sprinkler Arrangement, Class I Commodities, Storage Height Over 25 ft (7.6 m).

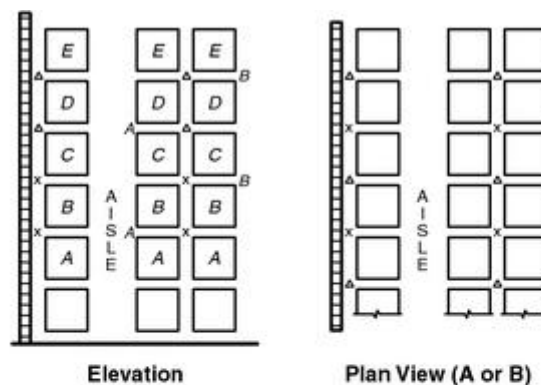

Notes:

1. Alternate location of in-rack sprinklers. Sprinklers shall be permitted to be installed above loads *A* and *C* or above loads *B* and *D*.
2. Symbol Δ or x indicates sprinklers on vertical or horizontal stagger.
3. Each square represents a storage cube measuring 4 ft to 5 ft (1.22 m to 1.53 m) on a side. Actual load heights can vary from approximately 18 in. (0.46 m) up to 10 ft (3.05 m). Therefore, there could be as few as one load or as many as six or seven loads between in-rack sprinklers that are spaced 10 ft (3.05 m) apart vertically.

FIGURE 16.3.4.1.1(c) In-Rack Sprinkler Arrangement, Class I, Class II, or Class III

Commodities, Storage Height 25 ft to Maximum 30 ft (7.6 m to Maximum 9.1 m).

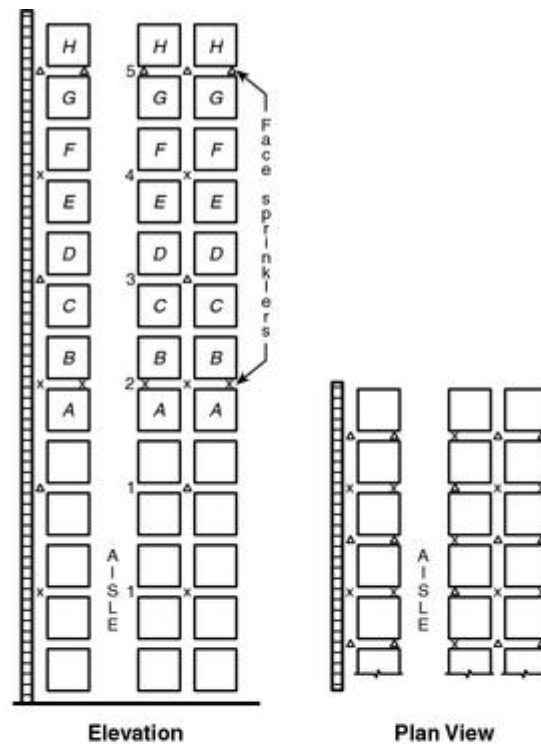

Notes:

1. Sprinklers labeled 1 shall be required where loads labeled A represent the top of storage.
2. Sprinklers labeled 1 and 2 shall be required where loads labeled B or C represent top of storage.
3. Sprinklers labeled 1, 2, and 3 shall be required where loads labeled D or E represent top of storage.
4. Sprinklers labeled 1, 2, 3, and 4 shall be required where loads labeled F or G represent top of storage.
5. Sprinklers labeled 1, 2, 3, and 5 shall be required where loads labeled H represent top of storage.
6. For storage higher than represented by loads labeled H, the cycle defined by Notes 3, 4, and 5 is repeated with stagger as indicated.
7. The indicated face sprinklers shall be permitted to be omitted where commodity consists of unwrapped or unpackaged metal parts on wood pallets.
8. Symbol Δ or x indicates sprinklers on vertical or horizontal stagger.
9. Each square represents a storage cube measuring 4 ft to 5 ft (1.22 m to 1.53 m) on a side. Actual load heights can vary from approximately 18 in. (0.46 m) up to 10 ft (3.05 m). Therefore, there could be as few as one load or as many as six or seven loads between in-rack sprinklers that are spaced 10 ft (3.05 m) apart vertically.

FIGURE 16.3.4.1.1(d) In-Rack Sprinkler Arrangement, Class I, Class II, or Class III Commodities, Storage Height Over 25 ft (7.6 m) — Option 1.

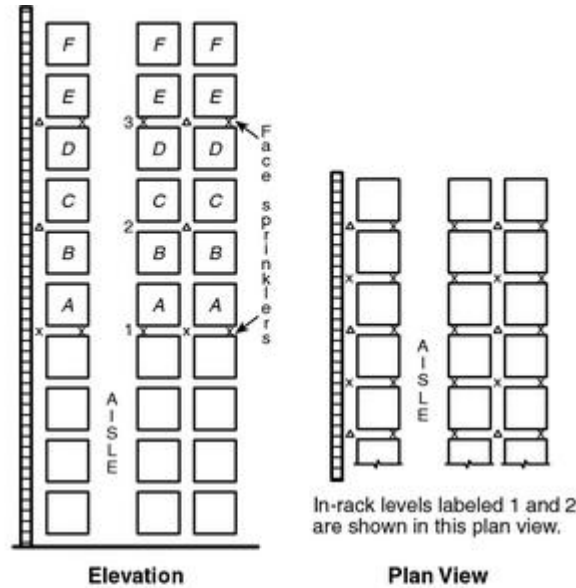

Notes:

1. Sprinklers labeled 1 (the selected array from Table 16.3.1.1) shall be required where loads labeled *A* or *B* represent top of storage.
2. Sprinklers labeled 1 and 2 shall be required where loads labeled *C* or *D* represent top of storage.
3. Sprinklers labeled 1 and 3 shall be required where loads labeled *E* or *F* represent top of storage.
4. For storage higher than represented by loads labeled *F*, the cycle defined by Notes 2 and 3 is repeated, with stagger as indicated.
5. Symbol Δ or x indicates sprinklers on vertical or horizontal stagger.
6. Each square represents a storage cube measuring 4 ft to 5 ft (1.22 m to 1.53 m) on a side. Actual load heights can vary from approximately 18 in. (0.46 m) up to 10 ft (3.05 m). Therefore, there could be as few as one load or as many as six or seven loads between in-rack sprinklers that are spaced 10 ft (3.05 m) apart vertically.

FIGURE 16.3.4.1.1(e) In-Rack Sprinkler Arrangement, Class I, Class II, or Class III Commodities, Storage Height Over 25 ft (7.6 m) — Option 2.

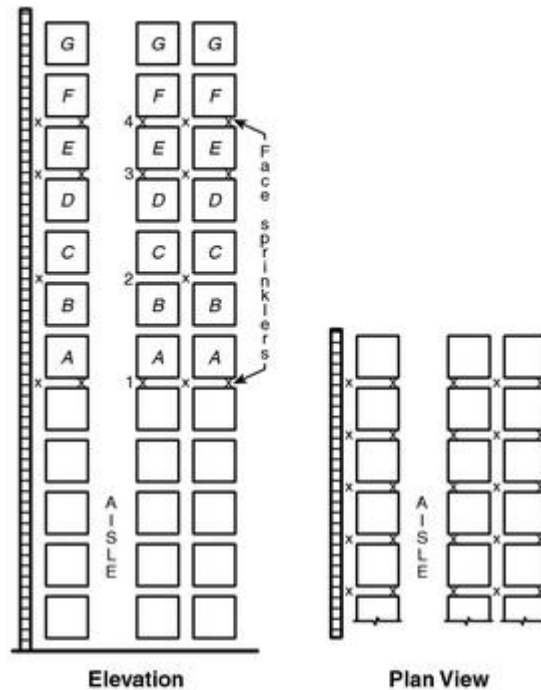

Notes:

1. Sprinklers labeled 1 (the selected array from Table 16.3.1.1) shall be required where loads labeled *A* or *B* represent top of storage.
2. Sprinklers labeled 1 and 2 shall be required where loads labeled *C* or *D* represent top of storage.
3. Sprinklers labeled 1 and 3 shall be required where loads labeled *E* represent top of storage.
4. Sprinklers labeled 1 and 4 shall be required where loads labeled *F* or *G* represent top of storage.
5. For storage higher than represented by loads labeled *G*, the cycle defined by Notes 2, 3, and 4 is repeated.
6. Symbol *x* indicates face and in-rack sprinklers.
7. Each square represents a storage cube measuring 4 ft to 5 ft (1.22 m to 1.53 m) on a side. Actual load heights can vary from approximately 18 in. (0.46 m) up to 10 ft (3.05 m). Therefore, there could be as few as one load or as many as six or seven loads between in-rack sprinklers that are spaced 10 ft (3.05 m) apart vertically.

FIGURE 16.3.4.1(f) In-Rack Sprinkler Arrangement, Class I, Class II, or Class III Commodities, Storage Height Over 25 ft (7.6 m) — Option 3.

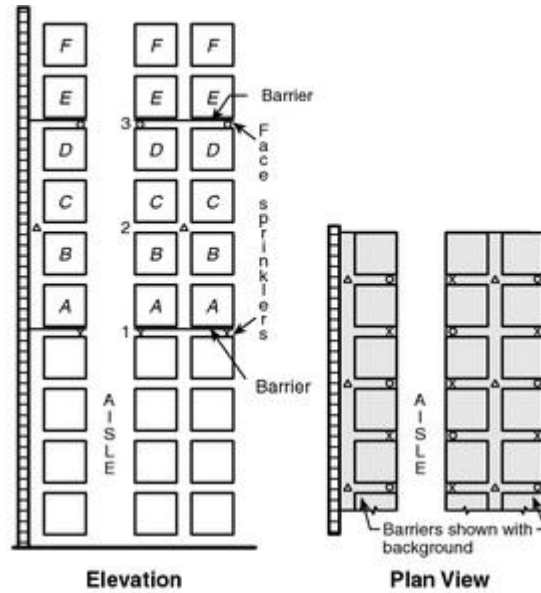

Notes:

1. Sprinklers labeled 1 (the selected array from Table 16.3.1.1) shall be required where loads labeled *A* or *B* represent top of storage.
2. Sprinklers labeled 1 and 2 shall be required where loads labeled *C* or *D* represent top of storage.
3. Sprinklers labeled 1 and 3 shall be required where loads labeled *E* or *F* represent top of storage.
4. For storage higher than represented by loads labeled *F*, the cycle defined by Notes 2 and 3 is repeated.
5. Symbols *o*, Δ , and *x* indicate sprinklers on vertical or horizontal stagger.
6. Each square represents a storage cube measuring 4 ft to 5 ft (1.22 m to 1.53 m) on a side. Actual load heights can vary from approximately 18 in. (0.46 m) up to 10 ft (3.05 m). Therefore, there could be as few as one load or as many as six or seven loads between in-rack sprinklers that are spaced 10 ft (3.05 m) apart vertically.

FIGURE 16.3.4.1.1(g) In-Rack Sprinkler Arrangement, Class I, Class II, or Class III Commodities, Storage Height Over 25 ft (7.6 m) — Option 4.

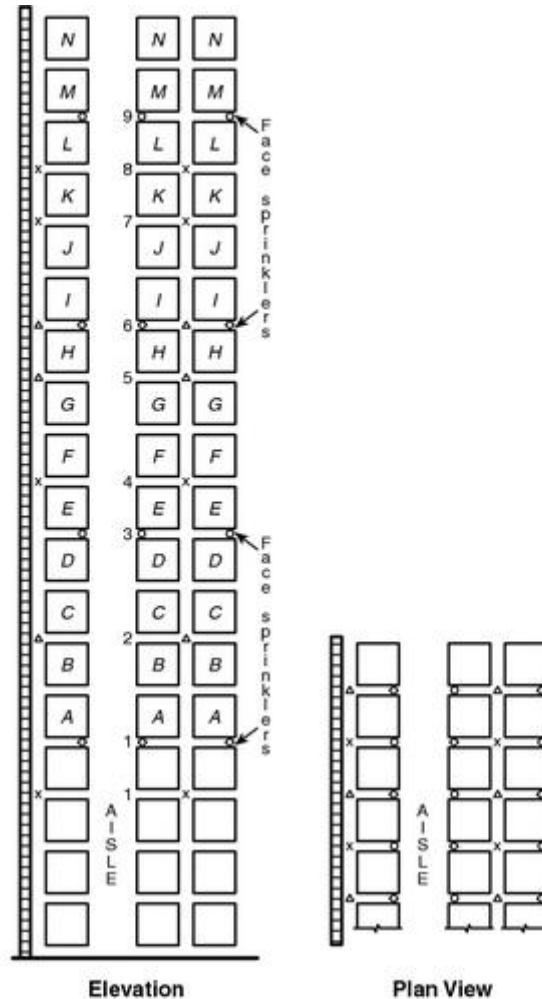

Notes:

1. Sprinklers labeled 1 (the selected array from Table 16.3.1.1) shall be required where loads labeled *A* or *B* represent top of storage.
2. Sprinklers labeled 1 and 2 shall be required where loads labeled *C* or *D* represent top of storage.
3. Sprinklers labeled 1, 2, and 3 shall be required where loads labeled *E* or *F* represent top of storage.
4. Sprinklers labeled 1, 2, 3, and 4 shall be required where loads labeled *G* represent top of storage.
5. Sprinklers labeled 1, 2, 3, 4, and 5 shall be required where loads labeled *H* represent top of storage.
6. Sprinklers labeled 1, 2, 3, 4, and 6 (not 5) shall be required where loads labeled *I* or *J* represent top of storage.
7. Sprinklers labeled 1, 2, 3, 4, 6, and 7 shall be required where loads labeled *K* represent top of storage.
8. Sprinklers labeled 1, 2, 3, 4, 6, and 8 shall be required where loads labeled *L* represent top of storage.
9. Sprinklers labeled 1, 2, 3, 4, 6, 8, and 9 shall be required where loads labeled *M* or *N* represent top of storage.
10. For storage higher than represented by loads labeled *N*, the cycle defined by Notes 1 through 9 is repeated, with stagger as indicated. In the cycle, loads labeled *M* are equivalent to loads labeled *A*.
11. Symbols *o*, *x*, and *Δ* indicate sprinklers on vertical or horizontal stagger.
12. Each square represents a storage cube measuring 4 ft to 5 ft (1.22 m to 1.53 m) on a side. Actual load heights can vary from approximately 18 in. (0.46 m) up to 10 ft (3.05 m). Therefore, there could be as few as one load or as many as six or seven loads between in-rack sprinklers that are spaced 10 ft (3.05 m) apart vertically.

FIGURE 16.3.4.1(h) In-Rack Sprinkler Arrangement, Class I, Class II, Class III, or

Class IV Commodities, Storage Height Over 25 ft (7.6 m) — Option 1.

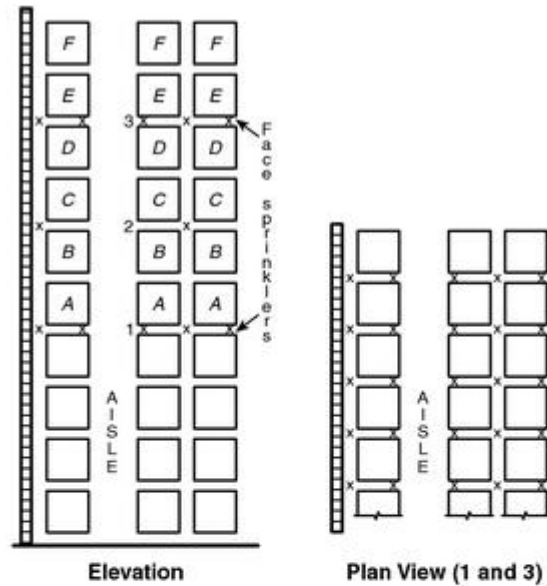

Notes:

1. Sprinklers labeled 1 (the selected array from Table 16.3.1.1) shall be required where loads labeled *A* or *B* represent top of storage.
2. Sprinklers labeled 1 and 2 shall be required where loads labeled *C* or *D* represent top of storage.
3. Sprinklers labeled 1 and 3 shall be required where loads labeled *E* or *F* represent top of storage.
4. For storage higher than represented by loads labeled *F*, the cycle defined by Notes 2 and 3 is repeated.
5. Symbol *x* indicates face and in-rack sprinklers.
6. Each square represents a storage cube measuring 4 ft to 5 ft (1.22 m to 1.53 m) on a side. Actual load heights can vary from approximately 18 in. (0.46 m) up to 10 ft (3.05 m). Therefore, there could be as few as one load or as many as six or seven loads between in-rack sprinklers that are spaced 10 ft (3.05 m) apart vertically.

FIGURE 16.3.4.1(i) In-Rack Sprinkler Arrangement, Class I, Class II, Class III, or Class IV Commodities, Storage Height Over 25 ft (7.6 m) — Option 2.

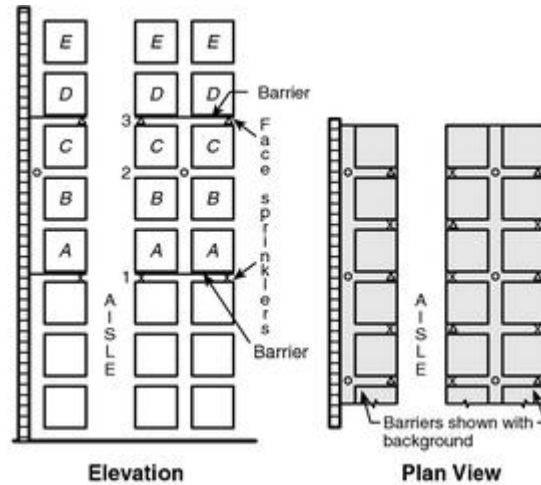

Notes:

1. Sprinklers labeled 1 (the selected array from Table 16.3.1.1) shall be required where loads labeled A or B represent top of storage.
2. Sprinklers labeled 1 and 2 and barrier labeled 1 shall be required where loads labeled C represent top of storage.
3. Sprinklers and barriers labeled 1 and 3 shall be required where loads labeled D or E represent top of storage.
4. For storage higher than represented by loads labeled E, the cycle defined by Notes 2 and 3 is repeated.
5. Symbol Δ or x indicates sprinklers on vertical or horizontal stagger.
6. Symbol \circ indicates longitudinal flue space sprinklers.
7. Each square represents a storage cube measuring 4 ft to 5 ft (1.22 m to 1.53 m) on a side. Actual load heights can vary from approximately 18 in. (0.46 m) up to 10 ft (3.05 m). Therefore, there could be as few as one load or as many as six or seven loads between in-rack sprinklers that are spaced 10 ft (3.05 m) apart vertically.

FIGURE 16.3.4.1.1(j) In-Rack Sprinkler Arrangement, Class I, Class II, Class III, or Class IV Commodities, Storage Height Over 25 ft (7.6 m) — Option 3.

16.3.4.1.1.1 In double-row racks without solid shelves and with a maximum of 10 ft (3.1 m) between the top of storage and the ceiling, in-rack sprinklers shall be installed in accordance with Table 16.3.1.1 and Figure 16.3.4.1.1(a) through Figure 16.3.4.1.1(j). The highest level of in-rack sprinklers shall be not more than 10 ft (3.1 m) below the top of storage. Where a single-row rack is mixed with double-row racks, Table 16.3.1.1 and Figure 16.3.4.1.1(a) through Figure 16.3.4.1.1(j) shall be used.

16.3.4.1.1.2 Figure 16.3.4.1.2(a) through Figure 16.3.4.1.2(c) shall be permitted to be used for the protection of the single-row racks.

16.3.4.1.2* Single-Row Racks. In single-row racks without solid shelves with storage height over 25 ft (7.6 m) and a maximum of 10 ft (3.1 m) between the top of storage and the ceiling, sprinklers shall be installed in accordance with Figure 16.3.4.1.2(a) through Figure 16.3.4.1.2(e). In single-row racks, where figures show in-rack sprinklers in transverse flue spaces centered between the rack faces, it shall be permitted to position these in-rack sprinklers in the transverse flue at any point between the load faces.

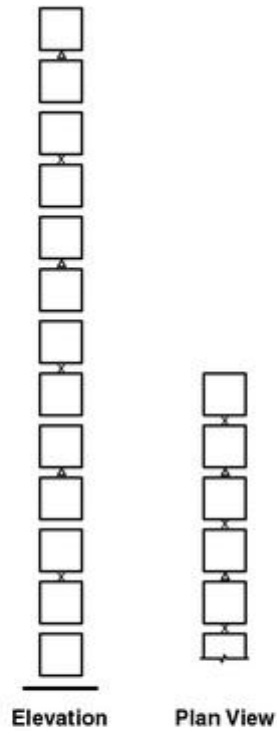

Notes:

1. For all storage heights, sprinklers shall be installed in every other tier and staggered as indicated.
2. Symbol Δ or x indicates sprinklers on vertical or horizontal stagger.
3. Each square represents a storage cube measuring 4 ft to 5 ft (1.22 m to 1.53 m) on a side. Actual load heights can vary from approximately 18 in. (0.46 m) up to 10 ft (3.05 m). Therefore, there could be as few as one load or as many as six or seven loads between in-rack sprinklers that are spaced 10 ft (3.05 m) apart vertically.

FIGURE 16.3.4.1.2(a) Class I, Class II, Class III, or Class IV Commodities, In-Rack Sprinkler Arrangement, Single-Row Racks, Storage Height Over 25 ft (7.6 m) — Option 1.

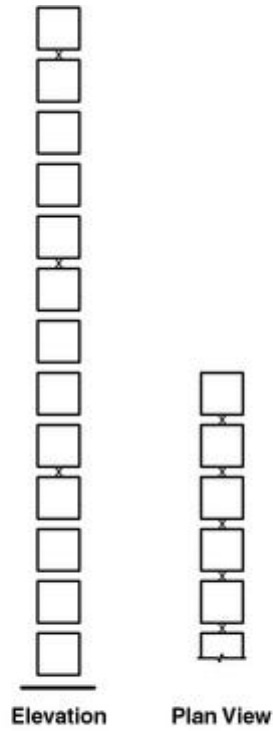

Note: Each square represents a storage cube measuring 4 ft to 5 ft (1.22 m to 1.53 m) on a side. Actual load heights can vary from approximately 18 in. (0.46 m) up to 10 ft (3.05 m). Therefore, there could be as few as one load or as many as six or seven loads between in-rack sprinklers that are spaced 10 ft (3.05 m) apart vertically.

FIGURE 16.3.4.1.2(b) Class I, Class II, or Class III Commodities, In-Rack Sprinkler Arrangement, Single-Row Racks, Storage Height Over 25 ft (7.6 m) — Option 1.

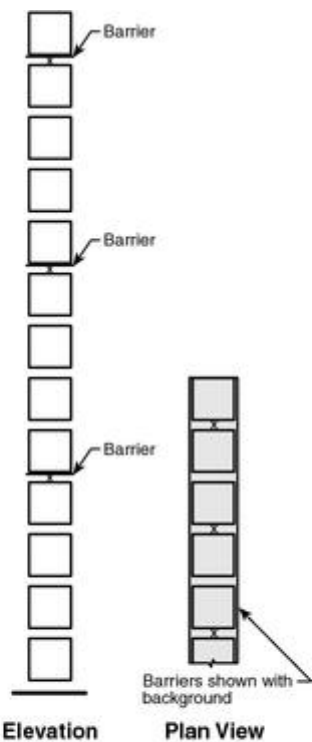

Note: Each square represents a storage cube measuring 4 ft to 5 ft (1.22 m to 1.53 m) on a side. Actual load heights can vary from approximately 18 in. (0.46 m) up to 10 ft (3.05 m). Therefore, there could be as few as one load or as many as six or seven loads between in-rack sprinklers that are spaced 10 ft (3.05 m) apart vertically.

FIGURE 16.3.4.1.2(c) Class I, Class II, or Class III Commodities, In-Rack Sprinkler Arrangement, Single-Row Racks, Storage Height Over 25 ft (7.6 m) — Option 2.

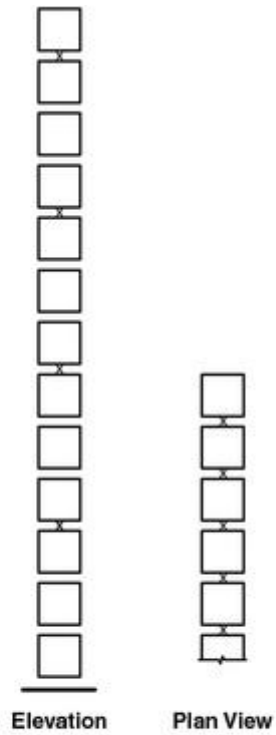

Note: Each square represents a storage cube measuring 4 ft to 5 ft (1.22 m to 1.53 m) on a side. Actual load heights can vary from approximately 18 in. (0.46 m) up to 10 ft (3.05 m). Therefore, there could be as few as one load or as many as six or seven loads between in-rack sprinklers that are spaced 10 ft (3.05 m) apart vertically.

FIGURE 16.3.4.1.2(d) Class I, Class II, Class III, or Class IV Commodities, In-Rack Sprinkler Arrangement, Single-Row Racks, Storage Height Over 25 ft (7.6 m) — Option 2.

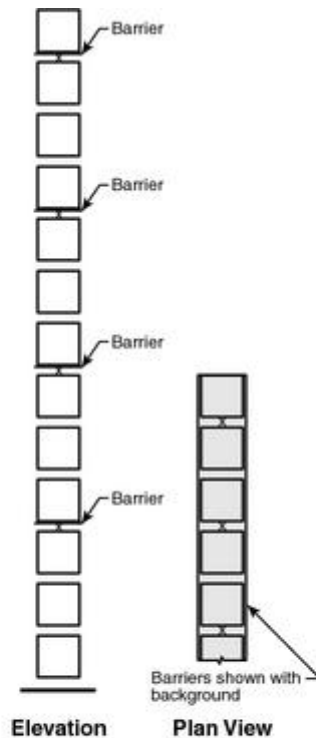

Note: Each square represents a storage cube measuring 4 ft to 5 ft (1.22 m to 1.53 m) on a side. Actual load heights can vary from approximately 18 in. (0.46 m) up to 10 ft (3.05 m). Therefore, there could be as few as one load or as many as six or seven loads between in-rack sprinklers that are spaced 10 ft (3.05 m) apart vertically.

FIGURE 16.3.4.1.2(e) Class I, Class II, Class III, or Class IV Commodities, In-Rack Sprinkler Arrangement, Single-Row Racks, Storage Height Over 25 ft (7.6 m) — Option 3.

16.3.4.1.3* In-Rack Sprinkler Location — Multiple-Row Racks for Rack Storage of Class I Through Class IV Commodities Stored Over 25 ft (7.6 m) in Height. In multiple-row racks with a maximum of 10 ft (3.1 m) between the top of storage and the ceiling, protection shall be in accordance with Table 16.3.1.2 and in-rack sprinklers shall be installed as indicated in Figure 16.3.4.1.3(a) through Figure 16.3.4.1.3(c). The highest level of in-rack sprinklers shall be not more than 10 ft (3.1 m) below maximum storage height for Class I, Class II, or Class III commodities or 5 ft (1.5 m) below the top of storage for Class IV commodities.

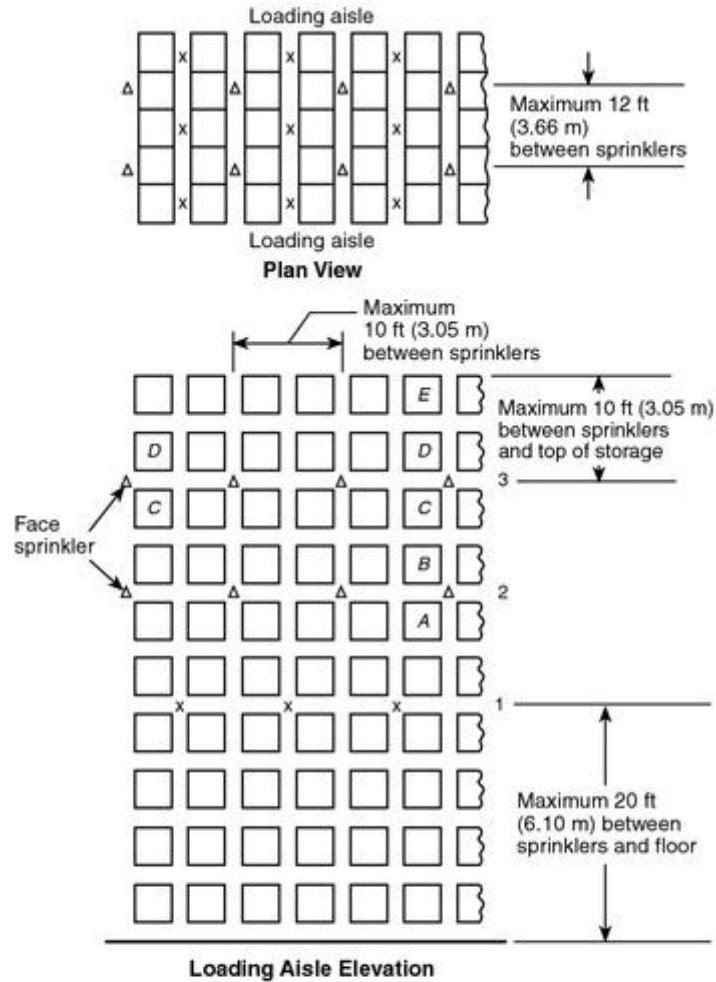

Notes:

1. Sprinklers labeled 1 shall be required if loads labeled *A* represent top of storage.
2. Sprinklers labeled 1 and 2 shall be required if loads labeled *B* or *C* represent top of storage.
3. Sprinklers labeled 1 and 3 shall be required if loads labeled *D* or *E* represent top of storage.
4. For storage higher than represented by loads labeled *E*, the cycle defined by Notes 2 and 3 is repeated, with stagger as indicated.
5. Symbol Δ or x indicates sprinklers on vertical or horizontal stagger.
6. Each square represents a storage cube measuring 4 ft to 5 ft (1.22 m to 1.53 m) on a side. Actual load heights can vary from approximately 18 in. (0.46 m) up to 10 ft (3.05 m). Therefore, there could be as few as one load or as many as six or seven loads between in-rack sprinklers that are spaced 10 ft (3.05 m) apart vertically.

FIGURE 16.3.4.1.3(a) In-Rack Sprinkler Arrangement — Multiple-Row Racks, Class I Commodities, Storage Height Over 25 ft (7.6 m).

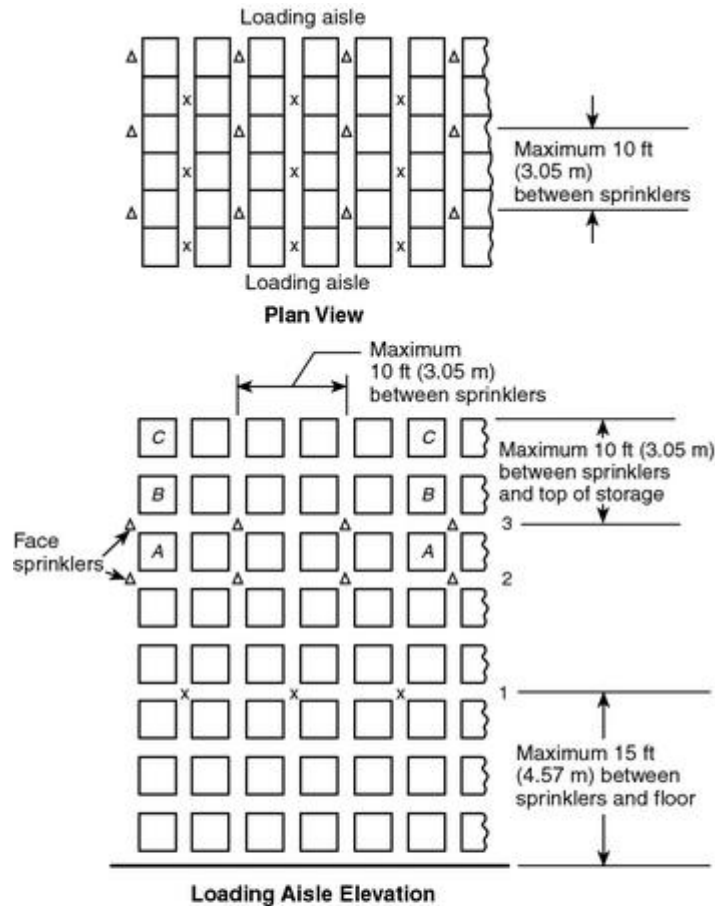

Notes:

1. Sprinklers labeled 1 and 2 shall be required if loads labeled *A* represent top of storage.
2. Sprinklers labeled 1 and 3 shall be required if loads labeled *B* or *C* represent top of storage.
3. For storage higher than represented by loads labeled *C*, the cycle defined by Notes 2 and 3 is repeated, with stagger as indicated.
4. Symbol Δ or *x* indicates sprinklers on vertical or horizontal stagger.
5. Each square represents a storage cube measuring 4 ft to 5 ft (1.22 m to 1.53 m) on a side. Actual load heights can vary from approximately 18 in. (0.46 m) up to 10 ft (3.05 m). Therefore, there could be as few as one load or as many as six or seven loads between in-rack sprinklers that are spaced 10 ft (3.05 m) apart vertically.

FIGURE 16.3.4.1.3(b) In-Rack Sprinkler Arrangement — Multiple-Row Racks, Class I, Class II, or Class III Commodities, Storage Height Over 25 ft (7.6 m).

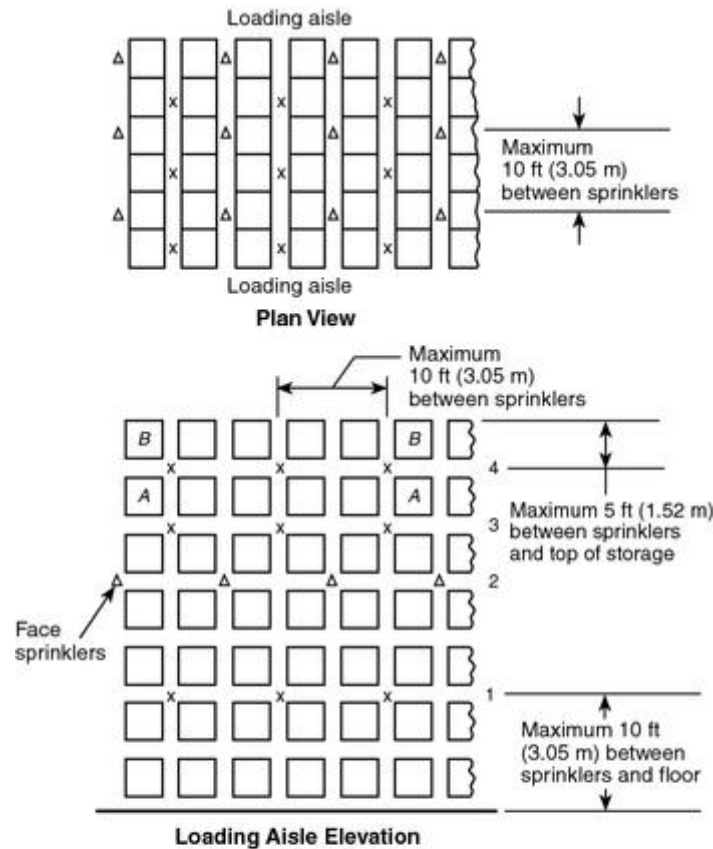

Notes:

1. Sprinklers labeled 1, 2, and 3 shall be required if loads labeled A represent top of storage.
2. Sprinklers labeled 1, 2, and 4 shall be required if loads labeled B represent top of storage.
3. For storage higher than represented by loads labeled B, the cycle defined by Notes 1 and 2 is repeated, with stagger as indicated.
4. Symbol Δ or x indicates sprinklers on vertical or horizontal stagger.
5. Each square represents a storage cube measuring 4 ft to 5 ft (1.22 m to 1.53 m) on a side. Actual load heights can vary from approximately 18 in. (0.46 m) up to 10 ft (3.05 m). Therefore, there could be as few as one load or as many as six or seven loads between in-rack sprinklers that are spaced 10 ft (3.05 m) apart vertically.

FIGURE 16.3.4.1.3(c) In-Rack Sprinkler Arrangement, Class I, Class II, Class III, or Class IV Commodities — Multiple-Row Racks, Storage Height Over 25 ft (7.6 m).

16.3.4.2 In-Rack Sprinkler Spacing for Rack Storage of Class I Through Class IV Commodities Stored Over 25 ft (7.6 m) in Height.

16.3.4.2.1 In-Rack Sprinkler Spacing. In-rack sprinklers shall be staggered horizontally and vertically where installed in accordance with Table 16.3.1.1, Figure 16.3.4.1.1(a) through Figure 16.3.4.1.1(j) and Figure 16.3.4.1.2(a) through Figure 16.3.4.1.2(e).

16.3.4.2.2 In-rack sprinklers for storage higher than 25 ft (7.6 m) in double-row racks shall be spaced horizontally and located in the horizontal space nearest the vertical intervals specified in Table 16.3.1.1 and Figure 16.3.4.1.1(a) through Figure 16.3.4.1.1(j).

16.3.4.2.3 In-Rack Sprinkler Spacing. Maximum horizontal spacing of sprinklers in multiple-row racks with storage higher than 25 ft (7.6 m) shall be in accordance with Figure Copyright NFPA

16.3.4.1.3(a) through Figure 16.3.4.1.3(c).

16.3.4.3 In-Rack Sprinkler Water Demand for Rack Storage of Class I Through Class IV Commodities Stored Over 25 ft (7.6 m) in Height. The water demand for sprinklers installed in racks shall be based on simultaneous operation of the most hydraulically remote sprinklers as follows:

- (1) Six sprinklers where only one level is installed in racks with Class I, Class II, or Class III commodities
- (2) Eight sprinklers where only one level is installed in racks with Class IV commodities
- (3) Ten sprinklers (five on each two top levels) where more than one level is installed in racks with Class I, Class II, or Class III commodities
- (4) Fourteen sprinklers (seven on each two top levels) where more than one level is installed in racks with Class IV commodities

16.3.4.3.1 In-Rack Sprinkler Discharge for Rack Storage of Class I Through Class IV Commodities Stored Over 25 ft (7.6 m) in Height. Sprinklers in racks shall discharge at a rate not less than 30 gpm (113.6 L/min) for all classes of commodities.

16.3.5 Special Design for Rack Storage of Class I Through Class IV Commodities Stored Over 25 ft (7.6 m) in Height.

16.3.5.1 Where high-expansion foam systems are used for storage over 25 ft (7.6 m) high up to and including 35 ft (10.7 m) high, they shall be used in combination with ceiling sprinklers. The maximum submergence time for the high-expansion foam shall be 5 minutes for Class I, Class II, or Class III commodities and 4 minutes for Class IV commodities.

Chapter 17 Protection of Plastic and Rubber Commodities That Are Stored on Racks

17.1 General.

17.1.1 This chapter shall apply to storage of plastic and rubber commodities stored in racks. The requirements of Chapter 12 shall apply unless modified by this chapter. *(See Section C.9.)*

17.1.2 Sprinkler Protection Criteria.

17.1.2.1 Plastic commodities shall be protected in accordance with Figure 17.1.2.1. This decision tree also shall be used to determine protection for commodities that are not entirely Group A plastics but contain such quantities and arrangements of Group A plastics that they are deemed more hazardous than Class IV commodities. The design criteria of 17.2.1 for single- and double-row rack storage of plastic commodities shall be applicable where aisles are 3.5 ft (1.07 m) or greater in width. Storage with aisles less than 3.5 ft (1.07 m) shall be protected as multiple-row rack storage. *(See Section C.21.)*

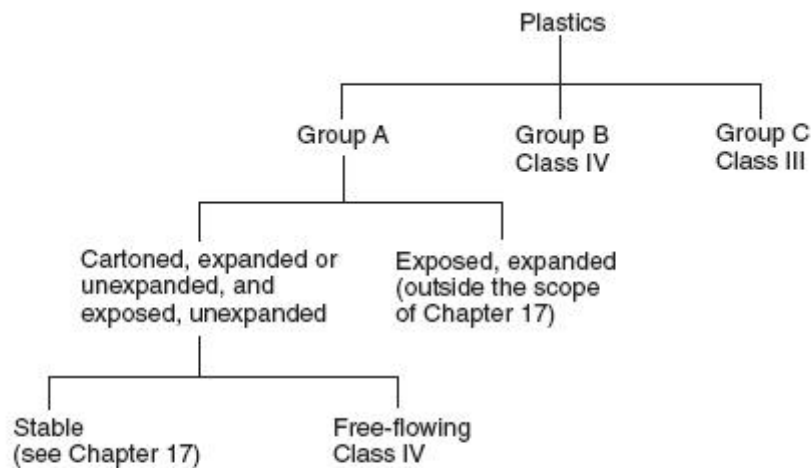

Note: Cartons that contain Group A plastic material shall be permitted to be treated as Class IV commodities under the following conditions:

- (1) There shall be multiple layers of corrugation or equivalent outer material that would significantly delay fire involvement of the Group A plastic.
- (2) The amount and arrangement of Group A plastic material within an ordinary carton would not be expected to significantly increase the fire hazard.

FIGURE 17.1.2.1 Decision Tree.

17.1.2.2 Group B plastics and free-flowing Group A plastics shall be protected the same as Class IV commodities.

17.1.2.3 Group C plastics shall be protected the same as Class III commodities.

17.1.2.4 Sprinkler protection criteria for the storage of materials on racks shall be in accordance with Section 17.2 for storage up to 25 ft (7.6 m), and Section 17.3 for storage over 25 ft (7.6 m).

17.1.2.5* Protection criteria for Group A plastics shall be permitted for the protection of the same storage height and configuration of Class I, II, III, and IV commodities.

17.1.3 Movable Racks. Rack storage in movable racks shall be protected in the same manner as multiple-row racks.

17.1.4 Fire Protection of Steel Columns — Columns Within Storage Racks. (See Section C.10.)

17.1.4.1 Where sprinkler protection of building columns within the rack structure or vertical rack members supporting the building are installed in lieu of fireproofing, sprinkler protection in accordance with one of the following shall be provided:

- (1) Sidewall sprinklers at the 15 ft (4.6 m) elevation, pointed toward one side of the steel column
- (2) Provision of ceiling sprinkler density for a minimum of 2000 ft² (186 m²) with ordinary 165°F (74°C) or high-temperature 286°F (141°C) rated sprinklers as shown

in Table 17.1.4.1 for storage heights above 15 ft (4.6 m), up to and including 20 ft (6.1 m)

- (3) Provision of large drop, specific application control mode or ESFR ceiling sprinkler protection
- (4) This protection shall not be required where storage in fixed racks is protected by in-rack sprinklers.

Table 17.1.4.1 Ceiling Sprinkler Densities for Protection of Steel Building Columns

Commodity Classification	Aisle Width			
	4 ft (1.2 m)		8 ft (2.4 m)	
	gpm/ft ²	(L/min)/m ²	gpm/ft ²	(L/min)/m ²
Class I	0.37	15.1	0.33	13.5
Class II	0.44	17.9	0.37	15.1
Class III	0.49	20	0.42	17.1
Class IV and Plastics	0.68	27.7	0.57	23.2

17.1.4.2 The flow from a column sprinkler(s) shall be permitted to be omitted from the sprinkler system hydraulic calculations.

17.1.5 Solid Shelving.

17.1.5.1 Where solid shelving in single-, double-, and multiple-row racks exceeds 20 ft² (1.86 m²) but does not exceed 64 ft² (5.95 m²) in area, sprinklers shall not be required below every shelf, but shall be installed at the ceiling and below shelves at intermediate levels not more than 6 ft (2 m) apart vertically. *(See Section C.11.)*

17.1.5.2 Where solid shelving in single-, double-, and multiple-row racks exceeds 64 ft² (5.95 m²) in area or where the levels of storage exceed 6 ft (2 m), sprinklers shall be installed at the ceiling and below each level of shelving.

17.1.5.3 In-rack sprinklers shall be horizontally spaced in accordance with 17.2.4 and 17.3.4.

17.1.5.4 Design criteria for combined ceiling and in-rack sprinklers shall be used for the storage configurations in 17.1.5.1 and 17.1.5.2.

17.1.6 Open-Top Combustible Containers. See Section C.12.

17.1.7 In-Rack Sprinklers.

17.1.7.1 The number of sprinklers and the pipe sizing on a line of sprinklers in racks shall be restricted only by hydraulic calculations and not by any piping schedule.

17.1.7.2 When in-rack sprinklers are necessary to protect a higher-hazard commodity that occupies only a portion of the length of a rack, in-rack sprinklers shall be extended a

minimum of 8 ft (2.44 m) or one bay, whichever is greater, in each direction along the rack on either side of the higher hazard. The in-rack sprinklers protecting the higher hazard need not be extended across the aisle.

17.1.7.3 Where a storage rack, due to its length, requires less than the number of in-rack sprinklers specified, only those in-rack sprinklers in a single rack need to be included in the calculation.

17.1.7.4* In-rack sprinklers shall be located at an intersection of transverse and longitudinal flues while not exceeding the maximum spacing rules. Where distances between transverse flues exceed the maximum allowable distances, sprinklers shall be installed at the intersection of the transverse and longitudinal flues and additional sprinklers shall be installed between transverse flues to meet the maximum distance rules. Where no transverse flues exist, in-rack sprinklers shall not exceed the maximum spacing rules.

17.1.8* Horizontal Barriers and In-Rack Sprinklers. Horizontal barriers used in conjunction with in-rack sprinklers to impede vertical fire development shall be constructed of sheet metal, wood, or similar material and shall extend the full length and depth of the rack. Barriers shall be fitted within 2 in. (51 mm) horizontally around rack uprights.

17.1.9 Flue Space Requirements for Storage Up to and Including 25 ft (7.6 m). In double-row and multiple-row racks without solid shelves, a longitudinal (back-to-back clearance between loads) flue space shall not be required. Nominal 6 in. (152.4 mm) transverse flue spaces between loads and at rack uprights shall be maintained in single-row, double-row, and multiple-row racks. Random variations in the width of flue spaces or in their vertical alignment shall be permitted. *(See Section C.13.)*

17.1.10 Flue Space Requirements for Storage Over 25 ft (7.6 m).

17.1.10.1 Nominal 6 in. (152.4 mm) transverse flue spaces between loads and at rack uprights shall be maintained in single-row, double-row, and multiple-row racks. Nominal 6 in. (152.4 mm) longitudinal flue spaces shall be provided in double-row racks. Random variations in the width of the flue spaces or in their vertical alignment shall be permitted.

17.1.10.2 In single-row, double-row, or multiple-row racks, a minimum 6 in. (152.4 mm) vertical clear space shall be maintained between the sprinkler deflectors and the top of a tier of storage. Face sprinklers in such racks shall be located a minimum of 3 in. (76 mm) from rack uprights and no more than 18 in. (460 mm) from the aisle face of storage. Longitudinal flue in-rack sprinklers shall be located at the intersection with the transverse flue space and with the deflector located at or below the bottom of horizontal load beams or above or below other adjacent horizontal rack members. Such in-rack sprinklers shall be a minimum of 3 in. (76 mm) radially from the side of the rack uprights.

17.2 Protection Criteria for Rack Storage of Plastics Commodities Stored Up to and Including 25 ft (7.6 m) in Height.

17.2.1 Control Mode Density-Area Sprinkler Protection Criteria for Single-, Double-, and Multiple-Row Racks for Plastics Commodities Stored Up to and Including 25 ft (7.6 m) in Height, with Clearances Up to and Including 10 ft (3.1 m).

17.2.1.1* For the storage of Group A plastics stored 5 ft (1.5 m) or less in height, the sprinkler design criteria for miscellaneous storage specified in Chapter 13 shall be used. The protection criteria in Chapter 13 shall be acceptable for storage of Group A plastic commodities up to and including 5 ft (1.5 m) in height. See Table 13.2.1 for specific Group A plastic storage height protection criteria.

17.2.1.2 Ceiling Sprinkler Water Demand. For Group A plastic commodities in cartons, encapsulated or nonencapsulated in single-, double-, and multiple-row racks, ceiling sprinkler water demand in terms of density [gpm/ft² (mm/min)] and area of operation [ft² (m²)] shall be selected from Figure 17.2.1.2(a) through Figure 17.2.1.2(f). Linear interpolation of design densities and areas of application shall be permitted between storage heights with the same clearances. No interpolation between clearances shall be permitted. (See Section C.22.)

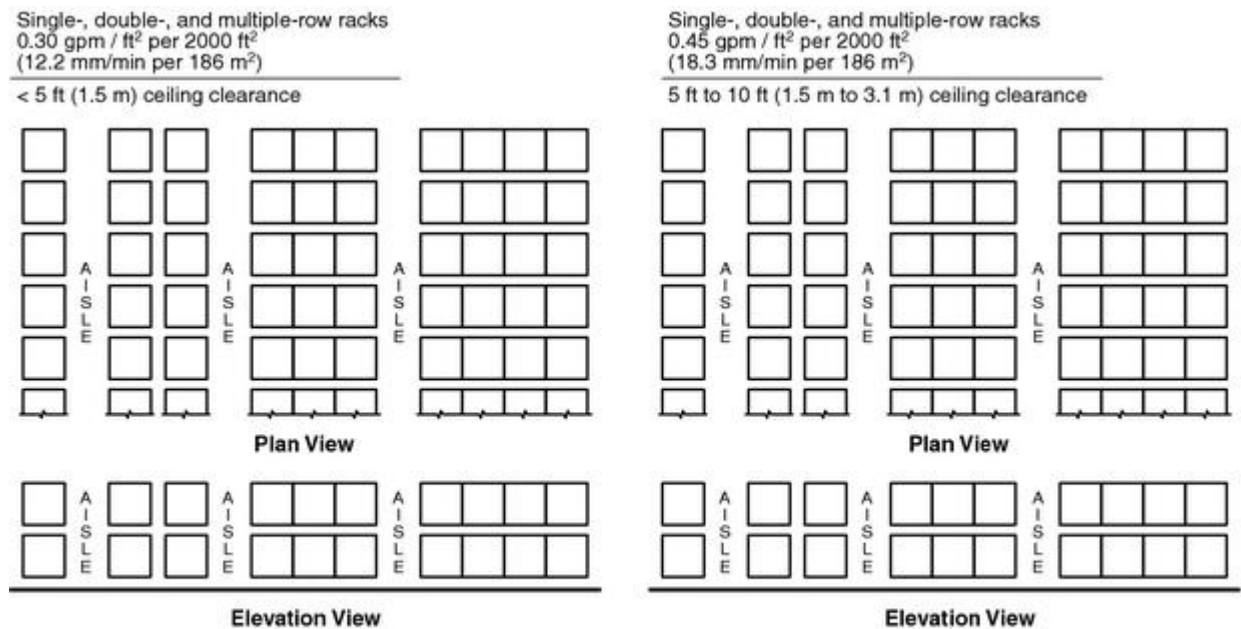

Note: Each square represents a storage cube measuring 4 ft to 5 ft (1.22 m to 1.52 m) on a side. Actual load heights can vary from approximately 18 in. (0.46 m) up to 10 ft (3.05 m). Therefore, there could be as few as one load or as many as six or seven loads between in-rack sprinklers that are spaced 10 ft (3.05 m) apart vertically.

FIGURE 17.2.1.2(a) 5 ft to 10 ft (1.5 m to 3 m) Storage; Up to 10 ft (3 m) Clearance to Ceiling.

Single- and double-row racks
 0.60 gpm / ft² per 2000 ft²
 (24.5 mm/min per 186 m²)

5 ft to 10 ft (1.5 m to 3.1 m)
 ceiling clearance
 See Note 2

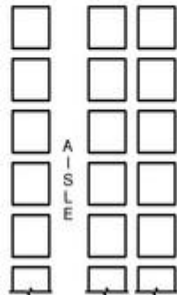

Plan View

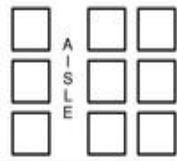

Elevation View

Multi-row racks
 0.60 gpm / ft² per 2000 ft²
 (24.5 mm/min per 186 m²)

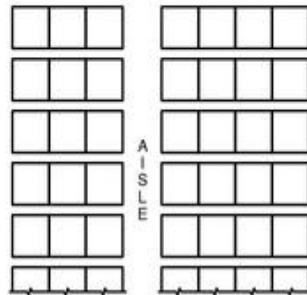

Plan View

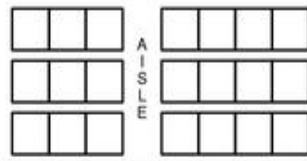

Elevation View

Single-, double-, and multiple-row racks
 0.30 gpm / ft² per 2000 ft²
 (12.2 mm/min per 186 m²)

5 ft to 10 ft (1.5 m to 3.1 m)
 ceiling clearance
 See Note 1

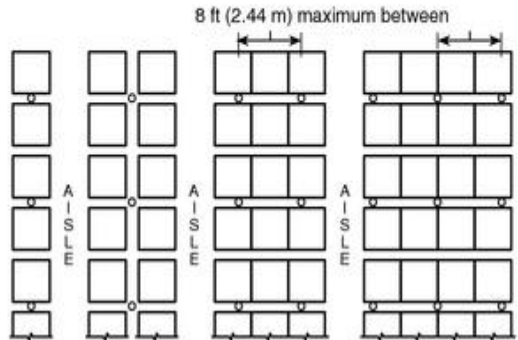

Plan View

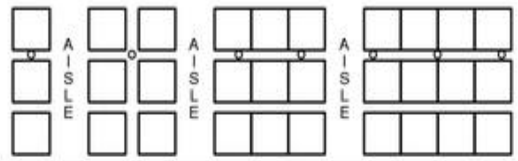

Elevation View

Notes:

1. Single level of in-rack sprinklers [$\frac{1}{2}$ in. or $\frac{17}{32}$ in. (12.7 mm or 13.5 mm) operating at 15 psi (1.03 bar) minimum] installed as indicated in the transverse flue spaces.
2. Where sprinklers listed for storage use are installed at the ceiling only and the ceiling height in the protected area does not exceed 22 ft (6.7 m) and a minimum clearance of 5 ft (1.53 m) and the storage height does not exceed 15 ft (4.6 m), the ceiling sprinkler discharge criteria shall be permitted to be reduced to 0.45 gpm/ft² per 2000 ft² (18.3 mm/min per 186 m²).
3. Each square represents a storage cube measuring 4 ft to 5 ft (1.22 m to 1.52 m) on a side. Actual load heights can vary from approximately 18 in. (0.46 m) up to 10 ft (3.05 m). Therefore, there could be as few as one load or as many as six or seven loads between in-rack sprinklers that are spaced 10 ft (3.05 m) apart vertically.

FIGURE 17.2.1.2(b) 15 ft (4.6 m) Storage; Up to 10 ft (1.5 m to 3.1 m) Clearance to Ceiling.

Single- and double-row racks
0.60 gpm / ft² per 2000 ft² (24.5 mm/min per 186 m²)

<5 ft (1.5 m) ceiling clearance

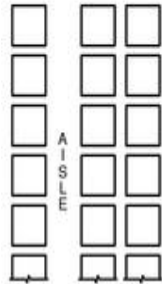

Plan View

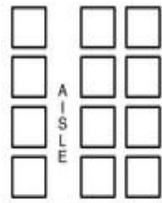

Elevation View

Single-, double-, and multiple-row racks
0.45 gpm / ft² per 2000 ft²
(18.3 mm/min per 186 m²)

<5 ft (1.5 m) ceiling clearance
See Note 1

8 ft (2.44 m) maximum between sprinklers

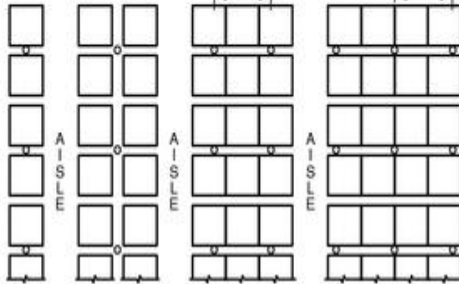

Plan View

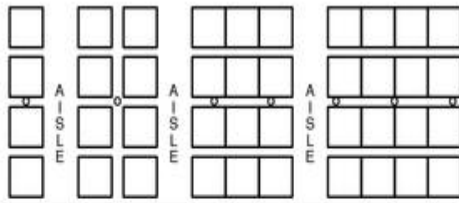

Elevation View

Single-, double-, and multiple-row racks
0.30 gpm / ft² per 2000 ft²
(12.2 mm/min per 186 m²)

<5 ft (1.5 m) ceiling clearance
See Note 2

8 ft (2.44 m) maximum between sprinklers

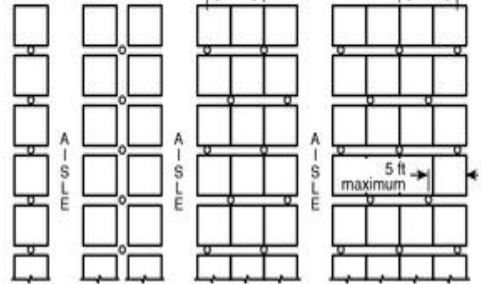

Plan View

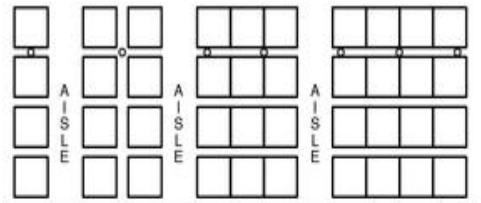

Elevation View

Notes:

1. Single level of in-rack sprinklers [$\frac{1}{2}$ in. or $1\frac{1}{2}$ in. (12.7 mm or 13.5 mm) operating at 15 psi (1.03 bar) minimum] installed as indicated in the transverse flue spaces.
2. Single level of in-rack sprinklers [$1\frac{1}{2}$ in. (13.5 mm) operating at 15 psi (1.03 bar) minimum or $\frac{1}{2}$ in. (12.7 mm) operating at 30 psi (2.07 bar) minimum] installed on 4 ft to 5 ft (1.25 m to 1.56 m) spacings located, as indicated, in the longitudinal flue space at the intersection of every transverse flue space.
3. Each square represents a storage cube measuring 4 ft to 5 ft (1.22 m to 1.52 m) on a side. Actual load heights can vary from approximately 18 in. (0.46 m) up to 10 ft (3.05 m). Therefore, there could be as few as one load or as many as six or seven loads between in-rack sprinklers that are spaced 10 ft (3.05 m) apart vertically.

FIGURE 17.2.1.2(c) 20 ft (6.1 m) Storage; <5 ft (1.5 m) Clearance to Ceiling.

0.45 gpm / ft² per 2000 ft²
 (18.3 mm/min per 186 m²)
 5 ft to 10 ft (1.5 m to 3.1 m) ceiling clearance
 See Notes 1, 2, and 5
 8 ft (2.44 m) maximum between sprinklers

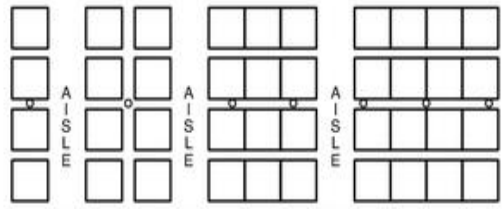
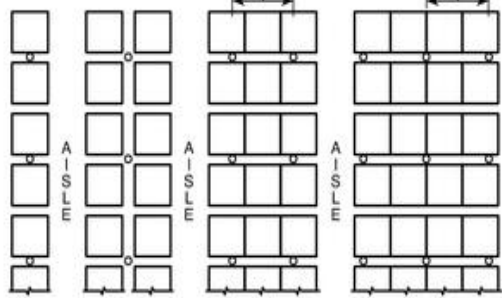

0.30 gpm / ft² per 2000 ft²
 (12.2 mm/min per 186 m²)
 5 ft to 10 ft (1.5 m to 3.1 m) ceiling clearance
 See Notes 2, 3, and 5
 8 ft (2.44 m) maximum between sprinklers

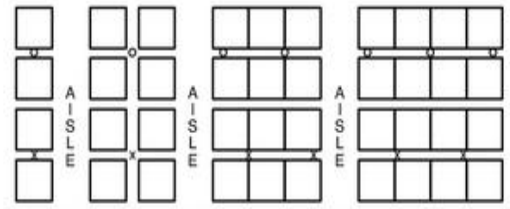
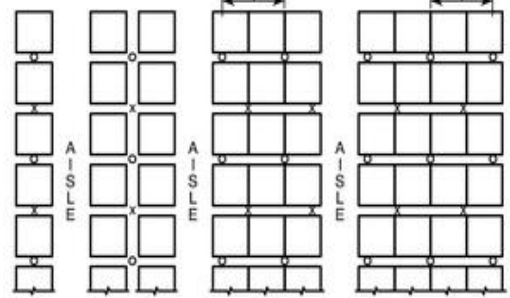

0.30 gpm / ft² per 2000 ft²
 (12.2 mm/min per 186 m²)
 5 ft to 10 ft (1.5 m to 3.1 m) ceiling clearance
 See Notes 2, 3, and 5
 8 ft (2.44 m) maximum between sprinklers

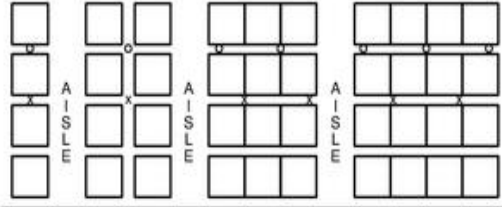
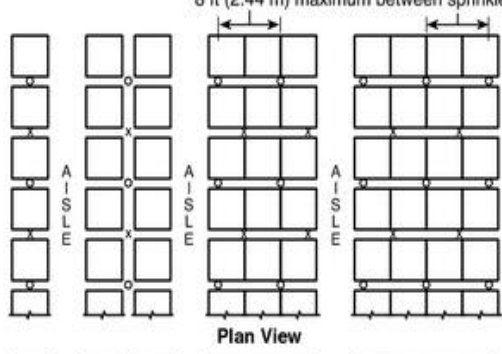

0.30 gpm / ft² per 2000 ft²
 (12.2 mm/min per 186 m²)
 5 ft to 10 ft (1.5 m to 3.1 m) ceiling clearance
 See Notes 2, 4, and 5
 8 ft (2.44 m) maximum between sprinklers

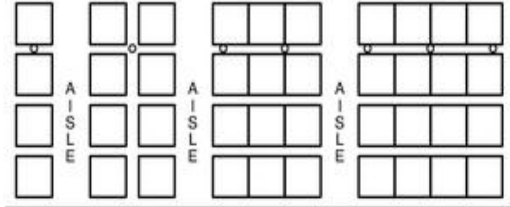
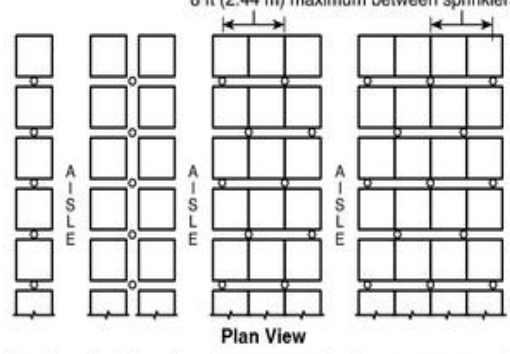

Notes:

1. Single level of in-rack sprinklers [$\frac{1}{2}$ in. or $\frac{1}{2}$ in. (12.7 mm or 13.5 mm) operating at 15 psi (1.03 bar) minimum] installed as indicated in the transverse flue spaces.
2. Ceiling only protection shall not be permitted for this storage configuration except where K-11.2, K-14, or K-16.8 spray sprinklers listed for storage use are installed. In-rack sprinklers shall not be required, provided the ceiling sprinkler discharge criterion is increased to 0.6 gpm/ft² (24 mm/min) over 2000 ft² (186 m²) and the ceiling height in the protected area does not exceed 27 ft (8.2 m).
3. Two levels of in-rack sprinklers [$\frac{1}{2}$ in. or $\frac{1}{2}$ in. (12.7 mm or 13.5 mm) operating at 15 psi (1.03 bar) minimum] installed as indicated and staggered in the transverse flue space.
4. Single level of in-rack sprinklers [$\frac{1}{2}$ in. (13.5 mm) operating at 15 psi (1.03 bar) or $\frac{1}{2}$ in. (12.7 mm) operating at 30 psi (2.07 bar) minimum] installed on 4 ft to 5 ft (1.22 m to 1.52 m) spacings located, as indicated, in the longitudinal flue space at the intersection of every transverse flue space.
5. Each square represents a storage cube measuring 4 ft to 5 ft (1.22 m to 1.52 m) on a side. Actual load heights can vary from approximately 18 in. (0.46 m) up to 10 ft (3.05 m). Therefore, there could be as few as one load or as many as six or seven loads between in-rack sprinklers that are spaced 10 ft (3.05 m) apart vertically.

FIGURE 17.2.1.2(d) 20 ft (6.1 m) Storage; 5 ft to 10 ft (1.5 m to 3.1 m) Clearance to Ceiling.

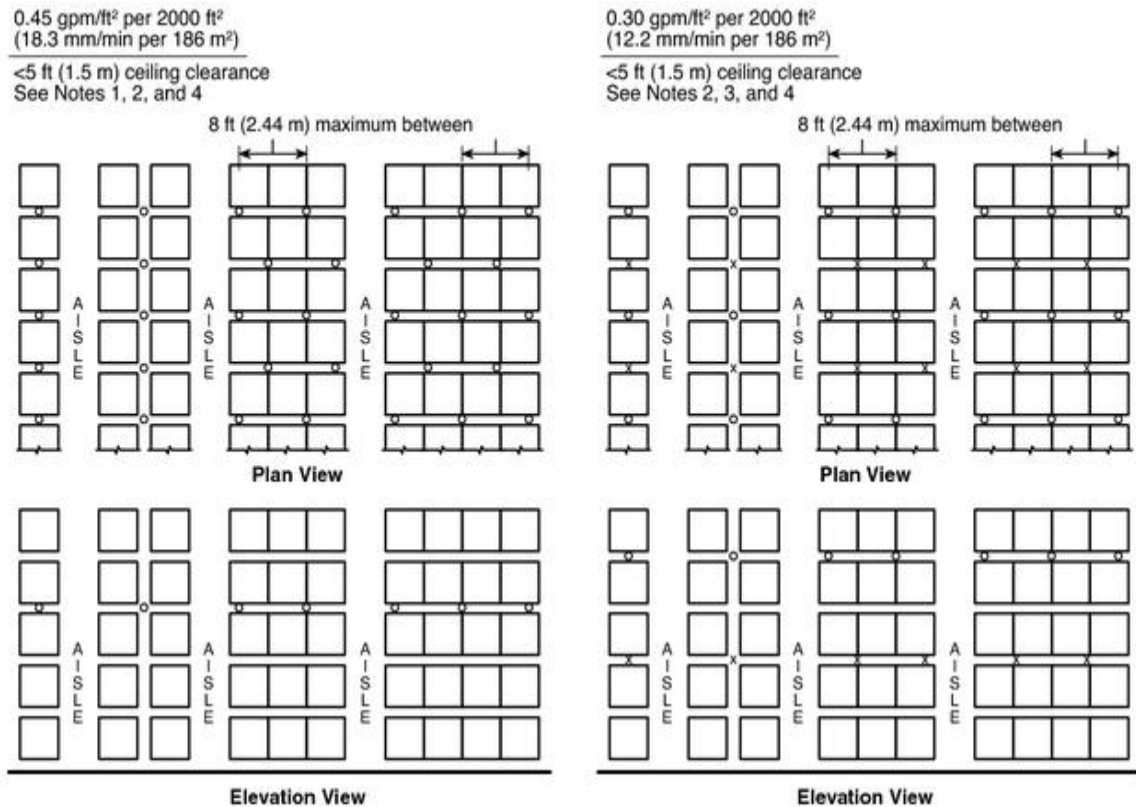

Notes:

1. Single level of in-rack sprinklers [$1\frac{1}{2}$ in. (13.5 mm) operating at 15 psi (1.03 bar) minimum or $\frac{1}{2}$ in. (12.7 mm) operating at 30 psi (2.07 bar) minimum] installed on 4 ft to 5 ft (1.22 m to 1.52 m) spacings located, as indicated, in the longitudinal flue space at the intersection of every transverse flue space.
2. Ceiling-only protection shall not be permitted for this storage configuration except where K-16.8 spray sprinklers listed for storage use are installed. In-rack sprinklers shall not be required, provided the ceiling sprinkler discharge criterion is increased to 0.8 gpm/ft² (32.6 mm/min) over 2000 ft² (186 m²) for wet systems and 4500 ft² (418 m²) for dry systems and the ceiling height in the protected area does not exceed 30 ft (9.1 m).
3. Two levels of in-rack sprinklers [$\frac{1}{2}$ in. or $1\frac{1}{2}$ in. (12.7 mm or 13.5 mm) operating at 15 psi (1.03 bar) minimum] installed as indicated and staggered in the transverse flue space.
4. Each square represents a storage cube measuring 4 ft to 5 ft (1.22 m to 1.52 m) on a side. Actual load heights can vary from approximately 18 in. (0.46 m) up to 10 ft (3.05 m). Therefore, there could be as few as one load or as many as six or seven loads between in-rack sprinklers that are spaced 10 ft (3.05 m) apart vertically.

FIGURE 17.2.1.2(e) 25 ft (7.6 m) Storage; <5 ft (1.5 m) Clearance to Ceiling. (See Note 2.)

0.30 gpm/ft² per 2000 ft²
(12.2 mm/min per 186 m²)

5 ft to 10 ft (1.5 m to 3.1 m) ceiling clearance
See Notes 1, 2, and 3

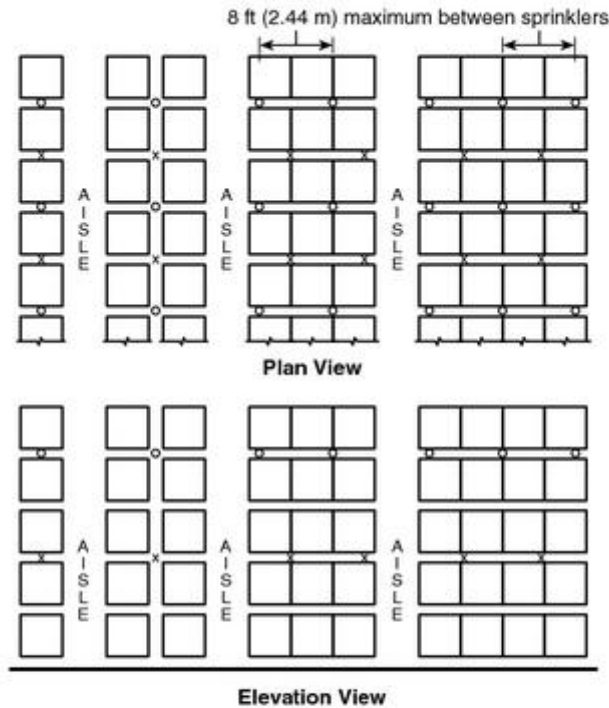

Notes:

1. Two levels of in-rack sprinklers [$\frac{1}{2}$ in. or $\frac{17}{32}$ in. (12.7 mm or 13.5 mm)] operating at 15 psi (1.03 bar) minimum] installed on 8 ft to 10 ft (2.4 m to 3.1 m) spacings located as indicated and staggered in the transverse flue space.
2. Ceiling-only protection shall not be permitted for this storage configuration except where K-16.8 spray sprinklers listed for storage use are installed. In-rack sprinklers shall not be required, provided the ceiling sprinkler discharge criterion is increased to 0.8 gpm/ft² (32.6 mm/min) over 2000 ft² (186 m²) for wet systems and 4500 ft² (418 m²) for dry systems and the ceiling height in the protected area does not exceed 30 ft (9.1 m).
3. Each square represents a storage cube measuring 4 ft to 5 ft (1.22 m to 1.52 m) on a side. Actual load heights can vary from approximately 18 in. (0.46 m) up to 10 ft (3.05 m). Therefore, there could be as few as one load or as many as six or seven loads between in-rack sprinklers that are spaced 10 ft (3.05 m) apart vertically.

FIGURE 17.2.1.2(f) 25 ft (7.6 m) Storage; 5 ft to 10 ft (1.5 m to 3.1 m) Clearance to Ceiling. (See Note 2.)

17.2.1.3 Single-, Double-, and Multiple-Row Racks Up to 10 ft (3.1 m) Storage with Up to 10 ft (3.1 m) Clearance. The protection strategies utilizing only ceiling sprinklers, as shown in Figure 17.2.1.2(a), shall be acceptable for single-, double-, and multiple-row rack storage.

17.2.1.4 Single- and Double-Row Rack Storage Greater Than 10 ft (3.1 m) Up to 15 ft (4.6 m) with Up to 10 ft (3.1 m) Clearance. The protection strategy utilizing only ceiling sprinklers, as shown in Figure 17.2.1.2(b), shall be acceptable only for single- and double-row rack storage.

17.2.1.5 Single- and Double-Row Rack Storage Greater Than 10 ft (3.1 m) Up to 15 ft

(4.6 m) with Clearance from 5 ft to 10 ft (1.5 m to 3.1 m), and Single- and Double-Row Rack Storage Up to 20 ft (6.1 m) with Less Than 5 ft (1.5 m) Clearance. The protection strategies utilizing only ceiling sprinklers, as shown in Figure 17.2.1.2(b) and Figure 17.2.1.2(c), shall be acceptable only for single- and double-row rack storage.

17.2.1.6 Multiple-Row Racks — 15 ft (4.6 m) Storage with Less Than 5 ft (1.5 m) Clearance. Where using the protection strategy utilizing only ceiling sprinklers, as shown in Figure 17.2.1.2(b), for multiple-row rack storage, the density to be used shall be 0.6 gpm/ft² (24.5 mm/min) over 2000 ft² (186 m²). The combination of ceiling and in-rack sprinklers specified in Figure 17.2.1.2(b) shall be permitted as an alternative.

17.2.1.7 Multiple-Row Racks — 15 ft (4.6 m) Storage with 10 ft (3.1 m) Clearance, and 20 ft (6.1 m) Storage with Up to 10 ft (3.1 m) Clearance. The protection strategies utilizing only ceiling sprinklers, as shown in Figure 17.2.1.2(b) through Figure 17.2.1.2(d), shall not be permitted for multiple-row rack storage. Only the specified combinations of ceiling and in-rack sprinklers shall be used.

17.2.1.8* The minimum water supply requirements for a hydraulically designed occupancy hazard fire control sprinkler system shall be determined by adding the hose stream allowance from Table 17.2.1.8 to the water supply for sprinklers determined in 17.2.1. This supply shall be available for the minimum duration specified in Table 17.2.1.8. *(See Section C.8.)*

Table 17.2.1.8 Hose Stream Allowance and Water Supply Duration Requirements for Rack Storage and Including 25 ft (7.6 m) in Height

Commodity Classification	Storage Height		Inside Hose	
	ft	m	gpm	L/min
Plastic	>5 up to 20	>1.5 up to 6.1	0, 50, or 100	0, 190, or 3
	>20 up to 25	>6.1 up to 7.6	0, 50, or 100	0, 190, or 3

17.2.2 Large Drop Sprinklers and Specific Application Control Mode Sprinklers for Rack Storage of Plastics Commodities Stored Up to and Including 25 ft (7.6 m) in Height.

17.2.2.1 Protection of single-, double-, and multiple-row rack storage without solid shelves for unexpanded plastic commodities shall be in accordance with Table 17.2.2.1(a) and Table 17.2.2.1(b).

Table 17.2.2.1(a) Large Drop Sprinkler Design Criteria for Single-, Double-, and Multiple-Row Rack Storage of Plastics Commodities Stored Up to and Including 25 ft (7.6 m) in Height

Commodity Classification	Maximum Storage Height	Maximum Ceiling/ Roof Height	Maximum Sprinkler Height	Minimum Sprinkler Height	Number of Sprinklers/M
					Pressurized
Plastic	>5 up to 20	>1.5 up to 6.1	0, 50, or 100	0, 50, or 100	0, 190, or 3
	>20 up to 25	>6.1 up to 7.6	0, 50, or 100	0, 50, or 100	0, 190, or 3

17.2.2.1 Protection of single-, double-, and multiple-row rack storage without solid shelves for unexpanded plastic commodities shall be in accordance with Table 17.2.2.1(a) and Table 17.2.2.1(b).

Table 17.2.2.1(a) Large Drop Sprinkler Design Criteria for Single-, Double-, and Multi Commodities Stored Up to and Including 25 ft (7.6 m)

Commodity Class	Nominal K-Factor	Maximum Storage Height		Maximum Ceiling/ Roof Height		Type of System	Number of Sprinklers/Minimum Pressure	
		ft	m	ft	m		/psi	
Cartoned or exposed unexpanded plastics	11.2 (161)	20	6.1	25	7.6	Wet	15/50	
						Dry	N/A	
Cartoned or exposed unexpanded plastics	11.2 (161)	20	6.1	30	9.1	Wet	30/50	
						Dry	N/A	
						Wet	20/75	
						Dry	N/A	
Cartoned or exposed unexpanded plastics	11.2 (161)	25	7.6	30	9.1	Wet	15/50 + 1 level of in-rack	
						Dry	N/A	
Cartoned or exposed unexpanded plastics	11.2 (161)	25	7.6	35	10.7	Wet	30/50 + 1 level of in-rack	
						Dry	N/A	
						Wet	20/75 + 1 level of in-rack	
						Dry	N/A	

Table 17.2.2.1(b) Specific Application Control Mode [16.8 K-factor (242)] Sprinkler Multiple-Row Racks Without Solid Shelves of Plastics Commodities Stored Up to and Including 25 ft (7.6 m)

Commodity Class	Maximum Storage Height		Maximum Building Height		Type of System	Number of Design Minimum Operating Pressure	
	ft	m	ft	m		10 psi (0.7 bar)	
Cartoned or exposed unexpanded plastics	25	7.6	30	9.1	Wet	—	

17.2.2.2 Where in-rack sprinklers are required by Table 17.2.2.1(a) and Table 17.2.2.1(b),

in-rack sprinkler spacing, design pressure, and hydraulic calculation criteria shall be in accordance with the requirements of 17.2.4 as applicable for the commodity.

17.2.2.3 Protection shall be provided as specified in Table 17.2.2.1(a) and Table 17.2.2.1(b) or appropriate NFPA standards in terms of minimum operating pressure and the number of sprinklers to be included in the design area.

17.2.2.4 Open Wood Joist Construction.

17.2.2.4.1 Where large drop K-11.2 (161) sprinklers are installed under open wood joist construction, their minimum operating pressure shall be 50 psi (3.4 bar).

17.2.2.4.2 Where each joist channel of open, wood joist construction is fully fire-stopped to its full depth at intervals not exceeding 20 ft (6.1 m), the lower pressures specified in Table 17.2.2.1(a) shall be permitted to be used.

17.2.2.5 The design area shall be a rectangular area having a dimension parallel to the branch lines at least 1.2 times the square root of the area protected by the number of sprinklers to be included in the design area. Any fractional sprinkler shall be included in the design area.

17.2.2.6 Hose stream allowance and water supply duration requirements shall be in accordance with those for extra hazard occupancies in Table 17.2.2.1(a) and Table 17.2.2.1(b).

17.2.2.7 Preaction Systems.

17.2.2.7.1 For the purpose of using Table 17.2.2.1(a) and Table 17.2.2.1(b), preaction systems shall be classified as dry pipe systems.

17.2.2.8 Building steel shall not require special protection where Table 17.2.2.1(a) or Table 17.2.2.1(b) is applied as appropriate for the storage configuration.

17.2.3* Early Suppression Fast-Response (ESFR) Sprinklers for Rack Storage of Plastics Commodities Stored Up to and Including 25 ft (7.6 m) in Height.

17.2.3.1 Protection of single-, double-, and multiple-row rack storage of cartoned or uncartoned unexpanded plastic and cartoned expanded plastic shall be in accordance with Table 17.2.3.1.

Table 17.2.3.1 ESFR Protection of Rack Storage Without Solid Shelves of Plastics Comr in Height

Storage Arrangement	Commodity	Maximum Storage Height		Maximum Ceiling/ Roof Height		Nominal K-Factor	Orientation	I (C)	
		ft	m	ft	m			p	

**Table 17.2.3.1 ESFR Protection of Rack Storage Without Solid Shelves of Plastics Com
in Height**

Storage Arrangement	Commodity	Maximum Storage Height		Maximum Ceiling/ Roof Height		Nominal K-Factor	Orientation	p
		ft	m	ft	m			
Single-row, double-row, and multiple-row rack (no open-top containers)	Cartoned unexpanded	20	6.1	25	7.6	14.0 (201)	Upright or pendent	5
						16.8 (242)	Upright/ Pendent	3
						22.4 (322)	Pendent	2
						25.2 (363)	Pendent	1
				30	9.1	14.0 (201)	Upright or pendent	5
						16.8 (242)	Upright/ Pendent	3
						22.4 (322)	Pendent	2
						25.2 (363)	Pendent	1
				35	10.7	14.0 (201)	Upright or pendent	7
						16.8 (242)	Upright/ Pendent	5
						22.4 (322)	Pendent	3
						25.2 (363)	Pendent	2
				40	12.2	14.0 (201)	Pendent	7
						16.8 (242)	Pendent	5
						22.4 (322)	Pendent	4
						25.2 (363)	Pendent	2
				45	13.7	14.0 (201)	Pendent	9
						16.8 (242)	Pendent	6
						22.4 (322)	Pendent	4

**Table 17.2.3.1 ESFR Protection of Rack Storage Without Solid Shelves of Plastics Comr
in Height**

Storage Arrangement	Commodity	Maximum Storage Height		Maximum Ceiling/ Roof Height		Nominal K-Factor	Orientation	p
		ft	m	ft	m			
						25.2 (363)	Pendent	4
				30	9.1	14.0 (201)	Upright or pendent	5
						16.8 (242)	Upright/ Pendent	3
						22.4 (322)	Pendent	2
						25.2 (363)	Pendent	1
						14.0	Upright or	6

**Table 17.2.3.1 ESFR Protection of Rack Storage Without Solid Shelves of Plastics Comr
in Height**

Storage Arrangement	Commodity	Maximum Storage Height		Maximum Ceiling/ Roof Height		Nominal K-Factor	Orientation	p
		ft	m	ft	m			
		25	7.6	32	9.8	(201)	pendent	
						16.8 (242)	Upright/ Pendent	4
				35	10.7	14.0 (201)	Upright or pendent	7
						16.8 (242)	Upright/ Pendent	5
						22.4 (322)	Pendent	3
						25.2 (363)	Pendent	2
						14.0 (201)	Pendent	7
						16.8 (242)	Pendent	5

**Table 17.2.3.1 ESFR Protection of Rack Storage Without Solid Shelves of Plastics Com
in Height**

Storage Arrangement	Commodity	Maximum Storage Height		Maximum Ceiling/ Roof Height		Nominal K-Factor	Orientation	p			
		ft	m	ft	m						
				40	12.2	22.4 (322)	Pendent	4			
						25.2 (363)	Pendent	2			
				45	13.7	14.0 (201)	Pendent	9			
						16.8 (242)	Pendent	6			
						22.4 (322)	Pendent	4			
						25.2 (363)	Pendent	4			
				Exposed unexpanded	20	6.1	25	7.6	14.0 (201)	Pendent	5
									16.8 (242)	Pendent	3
							30	9.1	14.0 (201)	Pendent	5
									16.8 (242)	Pendent	3
							35	10.7	14.0 (201)	Pendent	7
									16.8 (242)	Pendent	5
	40	12.2	14.0 (201)				Pendent	7			
			16.8 (242)				Pendent	5			
	45	13.7	14.0 (201)	Pendent	9						
			16.8 (242)	Pendent	6						
				30	9.1	14 (201)	Pendent	5			
						16.8 (242)	Pendent	3			

**Table 17.2.3.1 ESFR Protection of Rack Storage Without Solid Shelves of Plastics Com
in Height**

Storage Arrangement	Commodity	Maximum Storage Height		Maximum Ceiling/ Roof Height		Nominal K-Factor	Orientation	p			
		ft	m	ft	m						
		25	7.6	32	9.8	14.0 (201)	Pendent	6			
						16.8 (242)	Pendent	4			
				35	10.7	14.0 (201)	Pendent	7			
						16.8 (242)	Pendent	5			
				40	12.2	14.0 (201)	Pendent	7			
						16.8 (242)	Pendent	5			
						25.2 (363)	Pendent	5			
				45	13.7	14.0 (201)	Pendent	9			
						16.8 (242)	Pendent	6			
				Cartoned expanded	20	6.1	25	7.6	14.0 (201)	Upright or pendent	5
									16.8 (242)	Upright/ Pendent	3
							30	9.1	14.0 (201)	Upright or pendent	5
	16.8 (242)	Upright/ Pendent	3								
	25	7.6	30		9.1	14.0 (201)	Upright or pendent	5			
						16.8 (242)	Upright/ Pendent	3			
	32	9.8	14.0 (201)	Pendent	6						
			16.8 (242)	Upright/ Pendent	4						

17.2.3.1.1 ESFR protection as defined shall not apply to the following:

- (1) Rack storage involving solid shelves

(2) Rack storage involving combustible, open-top cartons or containers

17.2.3.2 ESFR sprinkler systems shall be designed such that the minimum operating pressure is not less than that indicated in Table 17.2.3.1 for type of storage, commodity, storage height, and building height involved.

17.2.3.3 The design area shall consist of the most hydraulically demanding area of 12 sprinklers, consisting of four sprinklers on each of three branch lines.

17.2.3.4 Where ESFR sprinklers are installed above and below obstructions, the discharge for up to two sprinklers for one of the levels shall be included with those of the other level in the hydraulic calculations.

17.2.4 In-Rack Sprinklers for Rack Storage of Plastics Commodities Stored Up to and Including 25 ft (7.6 m) in Height.

17.2.4.1 In-Rack Sprinkler Location for Rack Storage of Plastics Commodities Stored Up to and Including 25 ft (7.6 m) in Height. In-rack sprinklers shall be installed in accordance with Figure 17.2.1.2(a) through Figure 17.2.1.2(f).

17.2.4.2 In-Rack Sprinkler Spacing for Rack Storage of Plastics Commodities Stored Up to and Including 25 ft (7.6 m) in Height.

17.2.4.2.1 In-Rack Sprinkler Clearance. The minimum of 6 in. (152.4 mm) vertical clear space shall be maintained between the sprinkler deflectors and the top of a tier of storage.

17.2.4.2.2 The spacing of in-rack sprinklers shall be in accordance with Figure 17.2.1.2(a) through Figure 17.2.1.2(f).

17.2.4.3 In-Rack Sprinkler Water Demand for Rack Storage of Plastics Commodities Stored Up to and Including 25 ft (7.6 m) in Height. The water demand for sprinklers installed in racks shall be based on simultaneous operation of the most hydraulically remote sprinklers as follows:

- (1) Eight sprinklers where only one level is installed in racks
- (2) Fourteen sprinklers (seven on each top two levels) where more than one level is installed in racks

17.2.4.4 In-Rack Sprinkler Discharge Pressure for Rack Storage of Plastics Commodities Stored Up to and Including 25 ft (7.6 m) in Height. Sprinklers in racks shall discharge at not less than 15 psi (1 bar) for all classes of commodities. *(See Section C.19.)*

17.2.5 Special Design for Rack Storage of Plastics Commodities Stored Up to and Including 25 ft (7.6 m) in Height.

17.2.5.1 Slatted Shelves.

17.2.5.1.1* Slatted rack shelves shall be considered equivalent to solid rack shelves where the shelving is not considered open rack shelving or where the requirements of 17.2.5.1 are not met. *(See Section C.20.)*

17.2.5.1.2 A wet pipe system that is designed to provide a minimum of 0.6 gpm/ft² (24.5 mm/min) density over a minimum area of 2000 ft² (186 m²) or K-14.0 (201) ESFR sprinklers operating at a minimum of 50 psi (3.5 bar), K-16.8 (242) sprinklers operating at a minimum of 32 psi (1.7 bar), or K-25.2 (363) ESFR sprinklers operating at a minimum of 15 psi shall be permitted to protect single-row and double-row racks with slatted rack shelving racks where all of the following conditions are met:

- (1) Sprinklers shall be K-11.2 (161), K-14.0 (201), or K-16.8 (242) orifice spray sprinklers with a temperature rating of ordinary, intermediate, or high and shall be listed for storage occupancies or shall be K-14.0 (201), K-16.8 (242), or K-25.2 (363) ESFR.
- (2) The protected commodities shall be limited to Class I-IV, Group B plastics, Group C plastics, cartoned (expanded and unexpanded) Group A plastics, and exposed (unexpanded) Group A plastics.
- (3) Slats in slatted rack shelving shall be a minimum nominal 2 in. (38 mm) thick by maximum nominal 6 in. (140 mm) wide with the slats held in place by spacers that maintain a minimum 2 in. (51 mm) opening between each slat.
- (4) Where K-11.2 (161), K-14.0 (201), or K-16.8 (242) orifice sprinklers are used, there shall be no slatted shelf levels in the rack above 12 ft (3.7 m). Open rack shelving using wire mesh shall be permitted for shelf levels above 12 ft (3.7 m).
- (5) Transverse flue spaces at least 3 in. (76 mm) wide shall be provided at least every 10 ft (3.1 m) horizontally.
- (6) Longitudinal flue spaces at least 6 in. (152 mm) wide shall be provided for double-row racks. Longitudinal flue spaces shall not be required when ESFR sprinklers are used.
- (7) The aisle widths shall be at least 7½ ft (2.5 m).
- (8) The maximum roof height shall be 27 ft (8.2 m) or 30 ft where ESFR sprinklers are used.
- (9) The maximum storage height shall be 20 ft (6.1 m).
- (10) Solid plywood or similar materials shall not be placed on the slatted shelves so that they block the 2 in. (51 mm) spaces between slats, nor shall they be placed on the wire mesh shelves.

17.3 Protection Criteria for Rack Storage of Plastics Commodities Stored Over 25 ft (7.6 m) in Height.

17.3.1 Control Mode Density–Area Sprinkler Protection Criteria for Rack Storage of Plastics Commodities Stored Over 25 ft (7.6 m) in Height for Single-, Double-, and Multiple-Row Racks.

17.3.1.1* Ceiling Sprinkler Water Demand. For Group A plastic commodities in cartons, encapsulated or nonencapsulated, ceiling sprinkler water demand in terms of density [gpm/ft²

(mm/min)] and area of operation [ft² (m²)] shall be selected from Table 17.3.1.1.

Storage Height Above Top Level In-Rack Sprinklers		Ceiling Sprinklers Density	
ft	m	gpm/ft ²	mm/min
5 ft or less	1.5 m or less	0.30/2000	12.2/186 m ²
Over 5 ft up to 10 ft	Over 1.5 m up to 3.05 m	0.45/2000	18.3/186 m ²

17.3.1.2 Where a single-row rack is mixed with double-row racks, either Figure 17.3.1.2(a) or Figure 17.3.1.2(b) shall be used in accordance with the corresponding storage height.

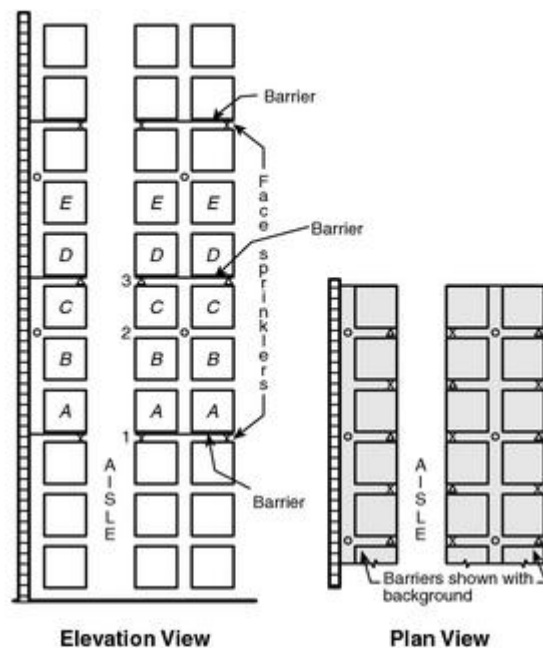

Notes:

1. Sprinklers and barriers labeled 1 shall be required where loads labeled A or B represent top of storage.
2. Sprinklers labeled 1 and 2 and barriers labeled 1 shall be required where loads labeled C represent top of storage.
3. Sprinklers and barriers labeled 1 and 3 shall be required where loads labeled D or E represent top of storage.
4. For storage higher than represented by loads labeled E, the cycle defined by Notes 2 and 3 is repeated.
5. Symbol Δ or x indicates face sprinklers on vertical or horizontal stagger.
6. Symbol o indicates longitudinal flue space sprinklers.
7. Each square represents a storage cube measuring 4 ft to 5 ft (1.22 m to 1.53 m) on a side. Actual load heights can vary from approximately 18 in. (0.46 m) up to 10 ft (3.05 m). Therefore, there could be as few as one load or as many as six or seven loads between in-rack sprinklers that are spaced 10 ft (3.05 m) apart vertically.

FIGURE 17.3.1.2(a) In-Rack Sprinkler Arrangement, Group A Plastic Commodities, Storage Height Over 25 ft (7.6 m) — Option 1.

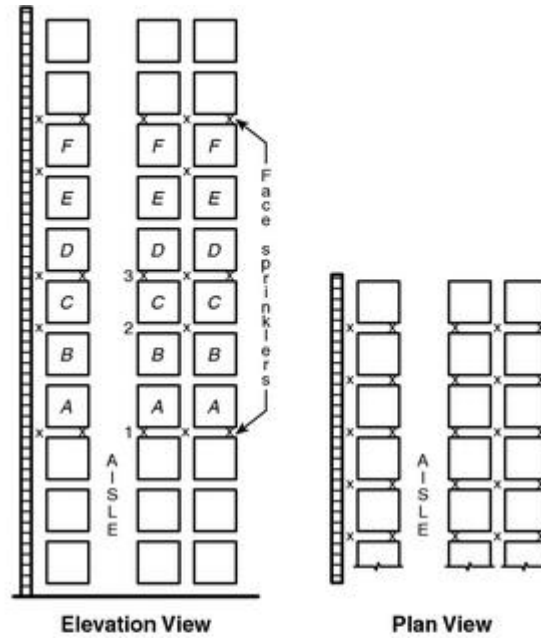

Notes:

1. Sprinklers labeled 1 shall be required where loads labeled *A* or *B* represent top of storage.
2. Sprinklers labeled 1 and 2 shall be required where loads labeled *C* represent top of storage.
3. Sprinklers labeled 1 and 3 shall be required where loads labeled *D* or *E* represent top of storage.
4. For storage higher than loads labeled *F*, the cycle defined by Notes 2 and 3 is repeated.
5. Symbol *x* indicates face and in-rack sprinklers.
6. Each square represents a storage cube measuring 4 ft to 5 ft (1.22 m to 1.53 m) on a side. Actual load heights can vary from approximately 18 in. (0.46 m) up to 10 ft (3.05 m). Therefore, there could be as few as one load or as many as six or seven loads between in-rack sprinklers that are spaced 10 ft (3.05 m) apart vertically.

FIGURE 17.3.1.2(b) In-Rack Sprinkler Arrangement, Group A Plastic Commodities, Storage Height Over 25 ft (7.6 m) — Option 2.

17.3.1.2.1 Figure 17.3.1.2.1(a) through Figure 17.3.1.2.1(c) shall be permitted to be used for the protection of the single-row racks.

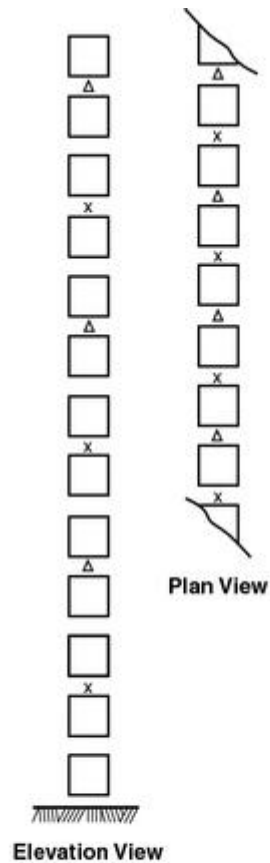

Note: Each square represents a storage cube measuring 4 ft to 5 ft (1.22 m to 1.53 m) on a side. Actual load heights can vary from approximately 18 in. (0.46 m) up to 10 ft (3.05 m). Therefore, there could be as few as one load or as many as six or seven loads between in-rack sprinklers that are spaced 10 ft (3.05 m) apart vertically.

FIGURE 17.3.1.2.1(a) In-Rack Sprinkler Arrangement, Group A Plastic Commodities, Single-Row Racks, Storage Height Over 25 ft (7.6 m) — Option 1.

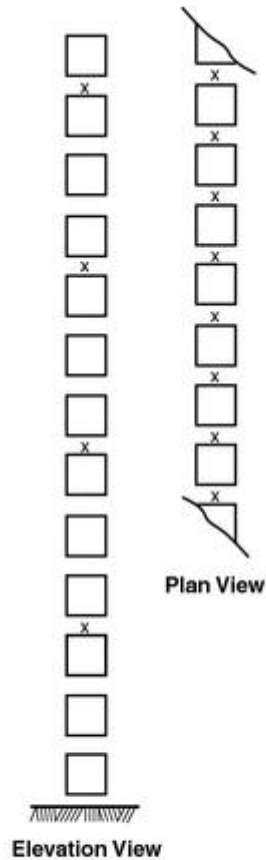

Note: Each square represents a storage cube measuring 4 ft to 5 ft (1.22 m to 1.53 m) on a side. Actual load heights can vary from approximately 18 in. (0.46 m) up to 10 ft (3.05 m). Therefore, there could be as few as one load or as many as six or seven loads between in-rack sprinklers that are spaced 10 ft (3.05m) apart vertically.

FIGURE 17.3.1.2.1(b) In-Rack Sprinkler Arrangement, Group A Plastic Commodities, Single-Row Racks, Storage Height Over 25 ft (7.6 m) — Option 2.

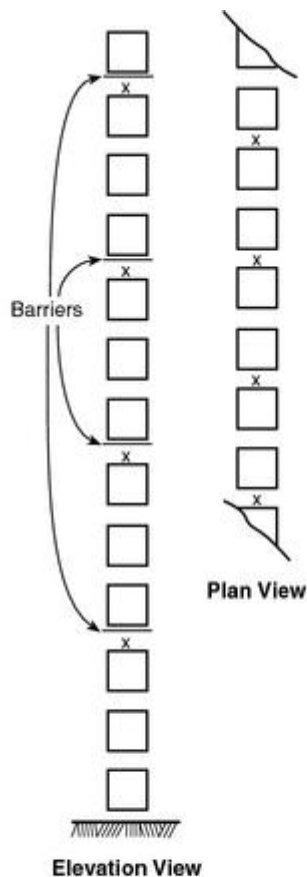

Note: Each square represents a storage cube measuring 4 ft to 5 ft (1.22 m to 1.53 m) on a side. Actual load heights can vary from approximately 18 in. (0.46 m) up to 10 ft (3.05 m). Therefore, there could be as few as one load or as many as six or seven loads between in-rack sprinklers that are spaced 10 ft (3.05 m) apart vertically.

FIGURE 17.3.1.2.1(c) In-Rack Sprinkler Arrangement, Group A Plastic Commodities, Single-Row Racks, Storage Height Over 25 ft (7.6 m) — Option 3.

17.3.1.3 The minimum water supply requirements for a hydraulically designed occupancy hazard fire control sprinkler system shall be determined by adding the hose stream allowance from Table 17.3.1.3 to the water supply for sprinklers determined in Section 17.3. This supply shall be available for the minimum duration specified in Table 17.3.1.3.

Table 17.3.1.3 Hose Stream Allowance and Water Supply Duration Requirements Commodities Stored Above 25 ft (7.6 m) in Height

Commodity Classification	Storage Height		Inside Hose		Total Cor Ot
	ft	m	gpm	L/min	gpm
Plastic	>25	>7.6	0, 50, 100	0, 190, 380	500

17.3.1.4 For Group A plastic commodities that are exposed and unexpanded, encapsulated

or unencapsulated, that are permitted to be protected in accordance with one of the in-rack options of 17.3.4.1.3, the ceiling sprinkler water demand in terms of density and area of operation shall be selected from Table 17.3.1.1.

17.3.2 Large Drop Sprinklers and Specific Application Control Mode Sprinklers for Rack Storage of Plastics Commodities Stored Over 25 ft (7.6 m) in Height. (Reserved)

17.3.3* Early Suppression Fast-Response (ESFR) Sprinklers for Rack Storage of Plastics Commodities Stored Over 25 ft (7.6 m) in Height.

17.3.3.1 Protection of single-, double-, and multiple-row rack storage of cartoned or uncartoned unexpanded plastic shall be in accordance with Table 17.3.3.1.

Table 17.3.3.1 ESFR Protection of Rack Storage Without Solid Shelves of Plastics Cor

Storage Arrangement	Commodity	Maximum Storage Height		Maximum Ceiling/ Roof Height		Nominal K-Factor	Orientation	p
		ft	m	ft	m			

Table 17.3.3.1 ESFR Protection of Rack Storage Without Solid Shelves of Plastics Cor

Storage Arrangement	Commodity	Maximum Storage Height		Maximum Ceiling/ Roof Height		Nominal K-Factor	Orientation	p
		ft	m	ft	m			
Single-row, Double-row, and Multiple-row Rack (No open-top containers)	Cartoned unexpanded	30	9.1	35	10.7	14.0 (201)	Upright or pendent	7
						16.8 (242)	Upright Pendent	5
						22.4 (322)	Pendent	3
						25.2 (363)	Pendent	2
				14.0 (201)	Pendent	7		
				16.8 (242)	Pendent	5		
				22.4 (322)	Pendent	4		
				25.2 (363)	Pendent	2		
				45	13.7	14.0 (201)	Pendent	9
						16.8 (242)	Pendent	6
						22.4 (322)	Pendent	4
						25.2 (363)	Pendent	4
		35	10.7	40	12.2	14.0 (201)	Pendent	7
						16.8 (242)	Pendent	5
						25.2 (363)	Pendent	2
				45	13.7	14.0 (201)	Pendent	9
						16.8 (242)	Pendent	6
						22.4 (322)	Pendent	4
						25.2 (322)	Pendent	4

Table 17.3.3.1 ESFR Protection of Rack Storage Without Solid Shelves of Plastics Cor

Storage Arrangement	Commodity	Maximum Storage Height		Maximum Ceiling/ Roof Height		Nominal K-Factor (201)	Orientation	p	
		ft	m	ft	m				
Exposed unexpanded		40	12.2	45	13.7	16.8 (242)	Pendent	6	
						22.4 (322)	Pendent	4	
						25.2 (322)	Pendent	4	
	30	9.1	40	12.2	35	10.7	14.0 (201)	Pendent	7
							16.8 (242)	Pendent	5
					14.0 (201)	Pendent	7		
					16.8 (242)	Pendent	5		
					25.2 (322)	Pendent	5		
					14.0 (201)	Pendent	9		
			45	13.7	16.8 (242)	Pendent	6		
						14.0 (201)	Pendent	7	
					40	12.2	16.8 (242)	Pendent	5
							25.2 (322)	Pendent	5
							14.0 (201)	Pendent	9
							16.8 (242)	Pendent	6
	35	10.7	40	12.2	45	13.7	14.0 (201)	Pendent	9
							16.8 (242)	Pendent	6
					25.2 (322)	Pendent	5		
			45	13.7	14.0 (201)	Pendent	9		
						16.8 (242)	Pendent	6	
14.0 (201)					Pendent	9			
40	12.2	45	13.7	14.0 (201)	Pendent	9			
				16.8 (242)	Pendent	6			

17.3.3.1.1 ESFR protection as defined shall not apply to the following:

- (1) Rack storage involving solid shelves
- (2) Rack storage involving combustible, open-top cartons or containers

17.3.3.2 ESFR sprinkler systems shall be designed such that the minimum operating pressure is not less than that indicated in Table 17.3.3.1 for type of storage, commodity, storage height, and building height involved.

17.3.3.3 The design area shall consist of the most hydraulically demanding area of 12 sprinklers, consisting of four sprinklers on each of three branch lines.

17.3.3.4 Where required by Table 17.3.3.1, one level of K-8.0 quick-response, ordinary-temperature in-rack sprinklers shall be installed at the tier level closest to but not exceeding ½ of the maximum storage height. In-rack sprinkler hydraulic design criteria shall be the most hydraulically remote eight sprinklers at 50 psi (3.4 bar). In-rack sprinklers shall be located at the intersection of the longitudinal and transverse flue space. Horizontal spacing shall not be permitted to exceed 5 ft (1.5 m) intervals.

17.3.3.5 Where ESFR sprinklers are installed above and below obstructions, the discharge for up to two sprinklers for one of the levels shall be included with those of the other level in the hydraulic calculations.

17.3.4 In-Rack Sprinklers for Rack Storage of Plastics Commodities Stored Over 25 ft (7.6 m) in Height.

17.3.4.1 In-Rack Sprinkler Location for Rack Storage of Plastics Commodities Stored Over 25 ft (7.6 m) in Height.

17.3.4.1.1 In double-row racks without solid shelves and with a maximum of 10 ft (3.1 m) between the top of storage and the ceiling, in-rack sprinklers shall be installed in accordance with Figure 17.3.1.2(a) or Figure 17.3.1.2(b). The highest level of in-rack sprinklers shall be not more than 10 ft (3.1 m) below the top of storage.

17.3.4.1.2 In single-row racks without solid shelves with storage height over 25 ft (7.6 m) and a maximum of 10 ft (3.1 m) between the top of storage and the ceiling, sprinklers shall be installed as indicated in Figure 17.3.1.2.1(a), Figure 17.3.1.2.1(b), or Figure 17.3.1.2.1(c).

17.3.4.1.3* In multiple-row racks without solid shelves with storage height over 25 ft (7.6 m) and a maximum of 10 ft (3.1 m) between the top of storage and the roof/ceiling, in-rack sprinklers shall be installed as indicated in Figure 17.3.4.1.3(a) through Figure 17.3.4.1.3(f).

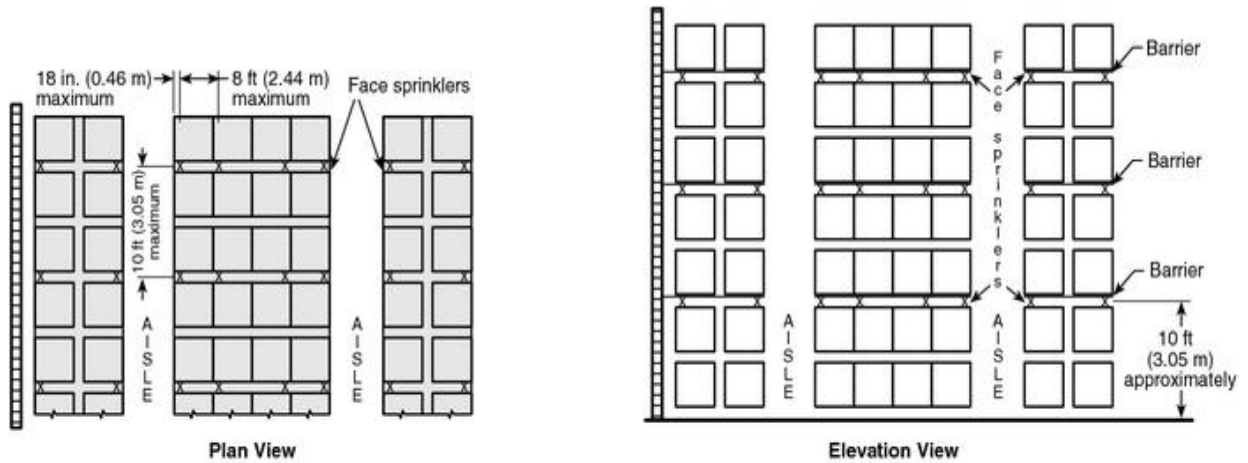

Note: Each square represents a storage cube measuring 4 ft to 5 ft (1.22 m to 1.52 m) on a side. Actual load heights can vary from approximately 18 in. (0.46 m) up to 10 ft (3.05 m). Therefore, there could be as few as one load or as many as six or seven loads between in-rack sprinklers that are spaced 10 ft (3.05 m) apart vertically.

FIGURE 17.3.4.1.3(a) In-Rack Sprinkler Arrangement, Cartoned Plastic and Uncartoned Unexpanded Plastic, Multiple-Row Racks, Storage Height Over 25 ft (7.6 m) — Option 1 [10 ft (3.05 m) Maximum Spacing].

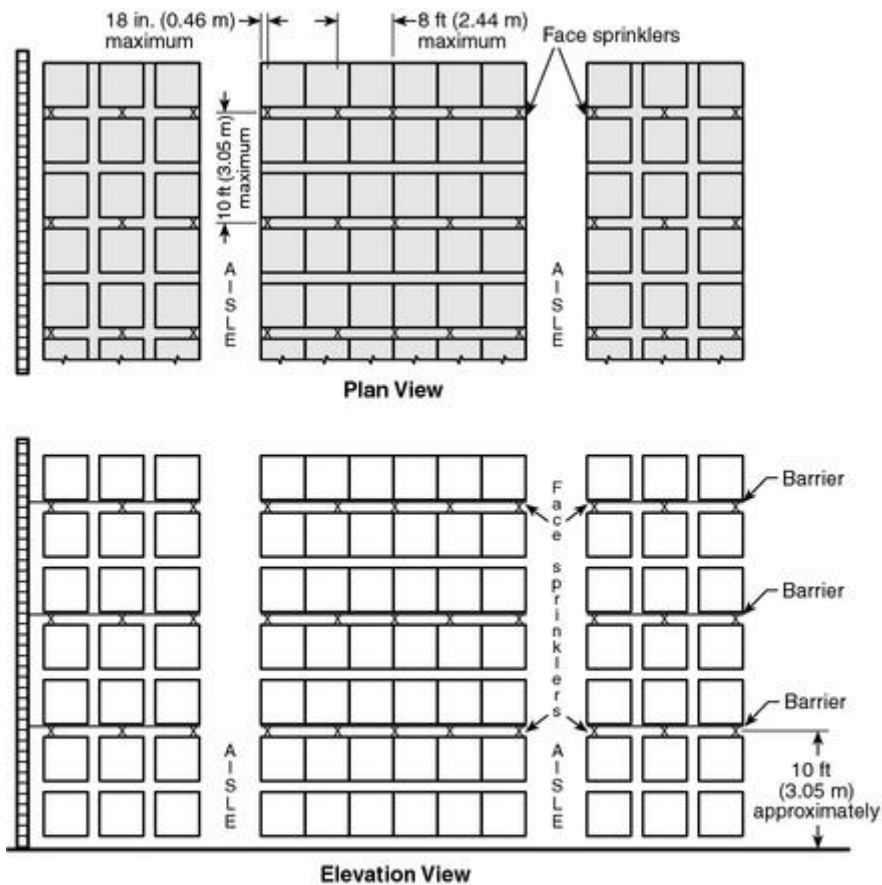

Note: Each square represents a storage cube measuring 4 ft to 5 ft (1.22 m to 1.53 m) on a side. Actual load heights can vary from approximately 18 in. (0.46 m) up to 10 ft (3.05 m). Therefore, there could be as few as one load or as many as six or seven loads between in-rack sprinklers that are spaced 10 ft (3.05 m) apart vertically.

FIGURE 17.3.4.1.3(b) In-Rack Sprinkler Arrangement, Cartoned Plastic and Uncartoned Unexpanded Plastic, Multiple-Row Racks, Storage Height Over 25 ft (7.6 m) — Option 2 [10 ft (3.05 m) Maximum Spacing].

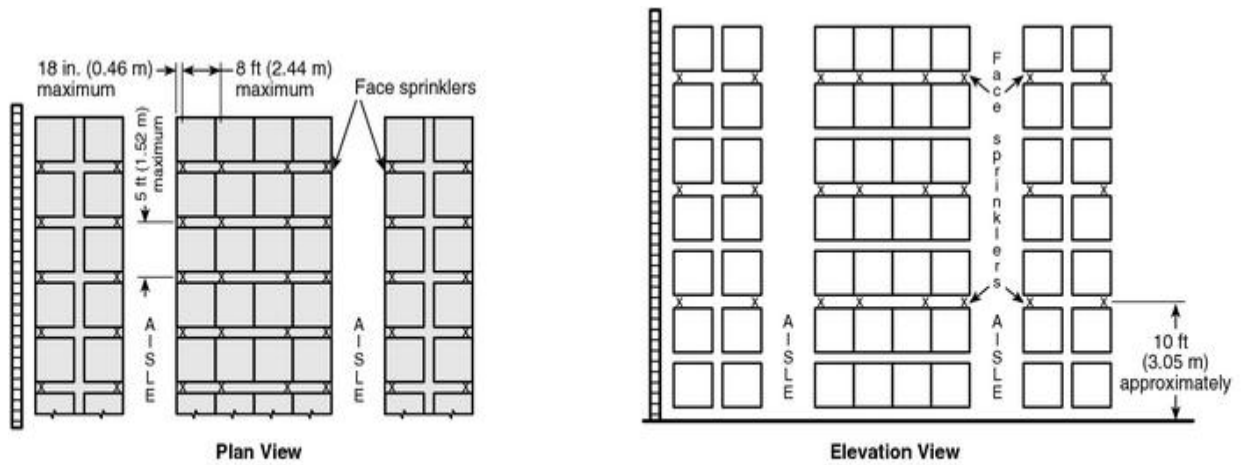

Note: Each square represents a storage cube measuring 4 ft to 5 ft (1.22 m to 1.52 m) on a side. Actual load heights can vary from approximately 18 in. (0.46 m) up to 10 ft (3.05 m). Therefore, there could be as few as one load or as many as six or seven loads between in-rack sprinklers that are spaced 10 ft (3.05 m) apart vertically.

FIGURE 17.3.4.1.3(c) In-Rack Sprinkler Arrangement, Cartoned Plastic and Uncartoned Unexpanded Plastic, Multiple-Row Racks, Storage Height Over 25 ft (7.6 m) — Option 1 [5 ft (1.52 m) Maximum Spacing].

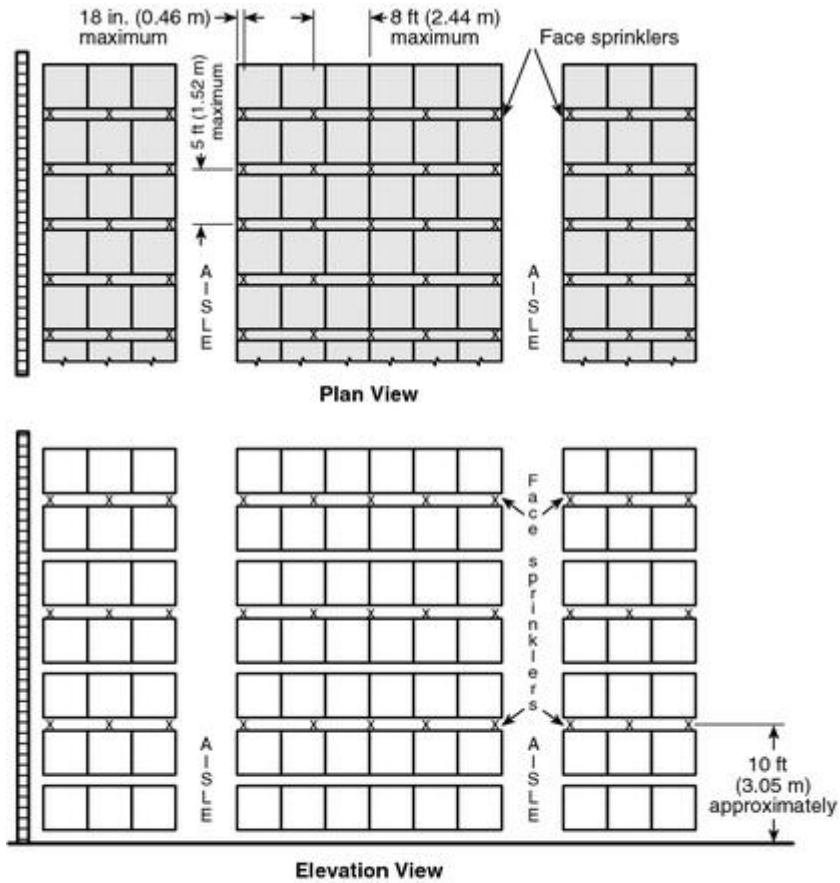

Note: Each square represents a storage cube measuring 4 ft to 5 ft (1.22 m to 1.52 m) on a side. Actual load heights can vary from approximately 18 in. (0.46 m) up to 10 ft (3.05 m). Therefore, there could be as few as one load or as many as six or seven loads between in-rack sprinklers that are spaced 10 ft (3.05 m) apart vertically.

FIGURE 17.3.4.1.3(d) In-Rack Sprinkler Arrangement, Cartoned Plastic and Uncartoned Unexpanded Plastic, Multiple-Row Racks, Storage Height Over 25 ft (7.6 m) — Option 2 [5 ft (1.52 m) Maximum Spacing].

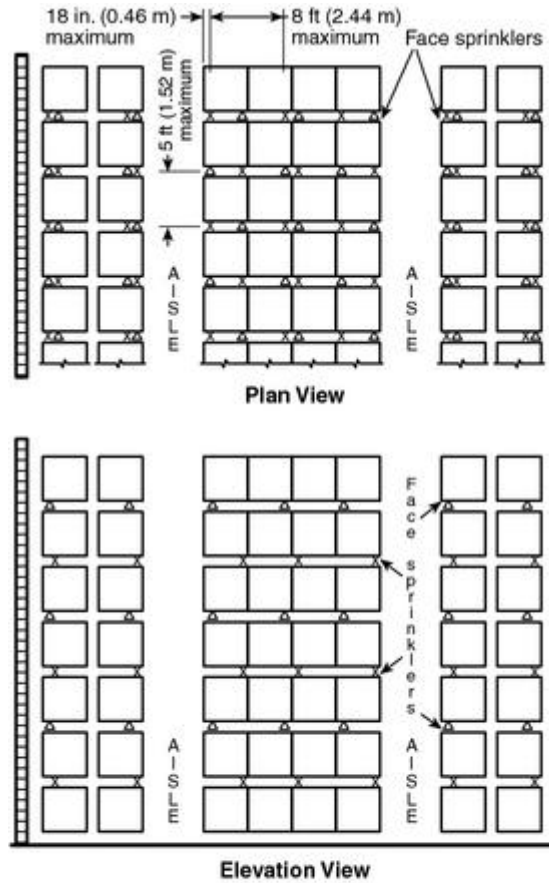

Note: Each square represents a storage cube measuring 4 ft to 5 ft (1.22 m to 1.53 m) on a side. Actual load heights can vary from approximately 18 in. (0.46 m) up to 10 ft (3.05 m). Therefore, there could be as few as one load or as many as six or seven loads between in-rack sprinklers that are spaced 10 ft (3.05 m) apart vertically.

FIGURE 17.3.4.1.3(e) In-Rack Sprinkler Arrangement, Cartoned Plastic and Uncartoned Unexpanded Plastic, Multiple-Row Racks, Storage Height Over 25 ft (7.6 m) — Option 3 [5 ft (1.52 m) Maximum Spacing].

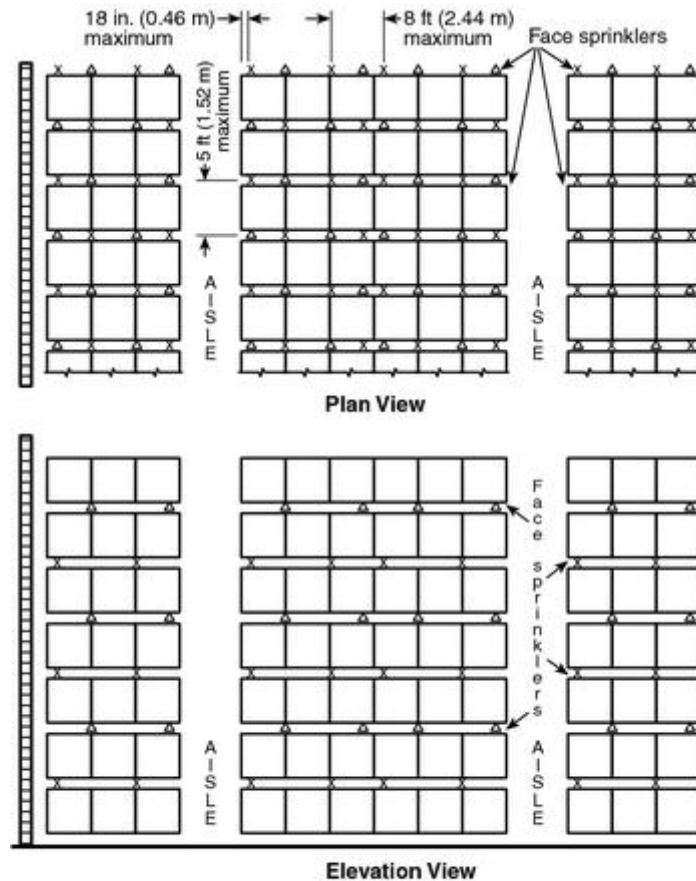

Note: Each square represents a storage cube measuring 4 ft to 5 ft (1.22 m to 1.53 m) on a side. Actual load heights can vary from approximately 18 in. (0.46 m) up to 10 ft (3.05 m). Therefore, there could be as few as one load or as many as six or seven loads between in-rack sprinklers that are spaced 10 ft (3.05 m) apart vertically.

FIGURE 17.3.4.1.3(f) In-Rack Sprinkler Arrangement, Cartoned Plastic and Uncartoned Unexpanded Plastic, Multiple-Row Racks, Storage Height Over 25 ft (7.6 m) — Option 4 [5 ft (1.52 m) Maximum Spacing].

17.3.4.1.4 In single-row and double-row racks without solid shelves with storage height over 25 ft (7.6 m) with aisles greater than 4 ft (1.2 m), in-rack sprinklers shall be located in accordance with Figure 17.3.4.1.4 and the ceiling sprinklers shall be designed for 0.45 gpm/ft² (18.3 mm/min) over a minimum design area of 2000 ft² (186 m²).

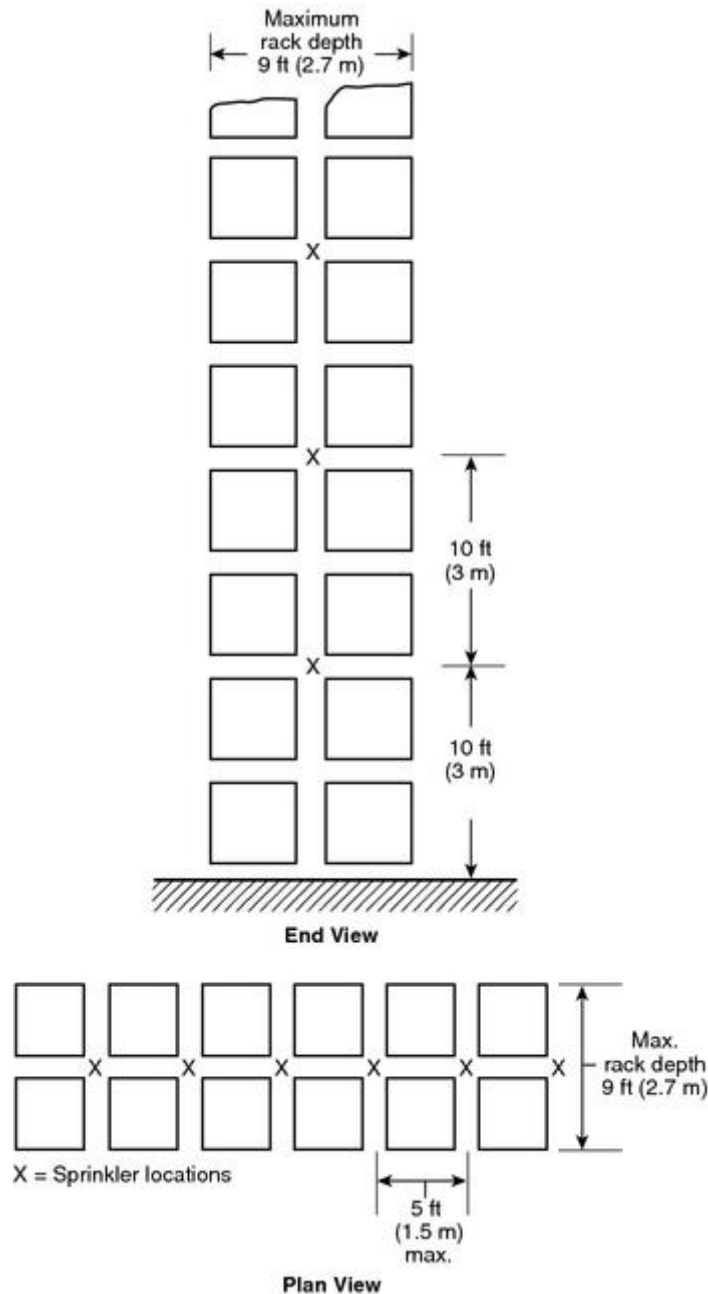

FIGURE 17.3.4.1.4 In-Rack Sprinkler Arrangement, Cartoned Expanded and Unexpanded Plastic and Uncartoned Unexpanded Plastic Commodities, Single- and Double-Row Racks, Storage Height Over 25 ft (7.6 m).

17.3.4.2 In-Rack Sprinkler Spacing for Rack Storage of Plastics Commodities Stored Over 25 ft (7.6 m) in Height.

17.3.4.2.1 In-rack sprinklers for storage higher than 25 ft (7.6 m) in double-row racks shall be spaced horizontally and shall be located in the horizontal space nearest the vertical intervals specified in Figure 17.3.1.2(a) or Figure 17.3.1.2(b).

17.3.4.2.2 The minimum of 6 in. (152.4 mm) vertical clear space shall be maintained

between the sprinkler deflectors and the top of a tier of storage.

17.3.4.3 In-Rack Sprinkler Water Demand for Rack Storage of Plastics Commodities Stored Over 25 ft (7.6 m) in Height. The water demand for sprinklers installed in racks shall be based on simultaneous operation of the most hydraulically remote sprinklers as follows:

- (1) Eight sprinklers where only one level is installed in racks
- (2) Fourteen sprinklers (seven on each top two levels) where more than one level is installed in racks

17.3.4.4 In-Rack Sprinkler Discharge Pressure for Rack Storage of Plastics Commodities Stored Over 25 ft (7.6 m) in Height. Sprinklers in racks shall discharge at not less than 30 gpm (113.6 L/min).

Chapter 18 Protection of Rubber Tire Storage

18.1 General.

The requirements of Chapter 12 shall apply unless modified by this chapter.

18.2 Columns Within Rubber Tire Storage.

18.2.1 Where fireproofing is not provided, steel columns shall be protected as follows:

- (1) Storage exceeding 15 ft through 20 ft (4.6 m through 6 m) in height — one sidewall sprinkler directed to one side of the column at a 15 ft (4.6 m) level
- (2) Storage exceeding 20 ft (6.1 m) in height — two sidewall sprinklers, one at the top of the column and the other at a 15 ft (4.6 m) level, both directed to the side of the column

18.2.2 The flow from a column sprinkler(s) shall be permitted to be omitted from the sprinkler system hydraulic calculations.

18.2.3 The protection specified in 18.2.1(1) and 18.2.1(2) shall not be required where storage in fixed racks is protected by in-rack sprinklers.

18.2.4 The protection specified in 18.2.1 shall not be required where ESFR or large drop sprinkler systems that are approved for rubber tire storage are installed.

18.2.5 The rate of water supply shall be sufficient to provide the required sprinkler discharge density over the required area of application plus provision for generation of high-expansion foam and in-rack sprinklers where used.

18.3 Water Supplies.

Total water supplies shall be in accordance with the following options:

- (1) A minimum of not less than 750 gpm (2835 L/min) for hose streams in addition to that required for automatic sprinklers and foam systems. Water supplies shall be

Copyright NFPA

capable of supplying the demand for sprinkler systems and hose streams for not less than 3 hours.

- (2) For on-floor storage up to and including 5 ft (1.5 m) in height, hose stream requirements shall be permitted to be 250 gpm (946 L/min) with a water supply duration of not less than 2 hours.
- (3) For ESFR and large drop sprinkler systems approved for rubber tire storage, duration and hose allowance shall be in accordance with Table 18.4(c) and Table 18.4(d).

18.4* Ceiling Systems.

Sprinkler discharge and area of application shall be in accordance with Table 18.4(a) for standard spray sprinklers. Large drop and ESFR sprinklers shall be in accordance with Table 18.4(c) and Table 18.4(d), respectively.

Table 18.4(a) Protection Criteria for Rubber Tire Storage Using Control Mode

Piling Method	Piling Height (ft)	Sprinkler Discharge Den (gpm/ft ²) (see Note 1)
(1) On-floor storage	Up to 5	0.19
(a) Pyramid piles, on-side	Over 5 to 12	0.30
(b) Other arrangements such that no horizontal channels are formed (see Note 2)	Over 12 to 18	0.60
(2) On-floor storage	Up to 5	0.19
Tires on-tread	Over 5 to 12	0.30
(3) Palletized portable rack storage	Up to 5	0.19
On-side or on-tread	Over 5 to 20	See Table 18.4(b)
	Over 20 to 30	0.30 plus high-expansion f
(4) Palletized portable rack storage on-side	Up to 5	0.19
	Over 5 to 20	See Table 18.4(b)
	Over 20 to 25	0.60 and 0.90 (see Note 3) or 0.75 with 1-hour fire-resist rating of roof and ceiling assembly
(5) Open portable rack storage, on-side or on-tread	Up to 5	0.19
	Over 5 to 12	0.60
	Over 12 to 20	0.60 and 0.90 (see Note 3) or 0.30 plus high-expansion f

Table 18.4(a) Protection Criteria for Rubber Tire Storage Using Control Mode

Piling Method	Piling Height (ft)	Sprinkler Discharge Den (gpm/ft ²) (see Note 1)
(6) Single-, double-, and multiple-row fixed rack storage on pallets, on-side, or on-tread without shelves	Up to 5	0.19
	Over 5 to 20	See Table 18.4(b) or 0.40 plus one level in-rack sprinklers or 0.30 plus high-expansion f
	Over 20 to 30	0.30 plus high-expansion f
(7) Single-, double-, and multiple-row fixed rack storage without pallets or shelves, on-side or on-tread	Up to 5	0.19
	Over 5 to 12	0.60
	Over 12 to 20	0.60 and 0.90 (see Note 3) or
		0.40 plus one level in-rack sprinklers or
	Over 20 to 30	0.30 plus high-expansion f

For SI units, 1 ft = 0.3048 m; 1 ft² = 0.0929 m²; 1 gpm/ft² = 40.746 mm/min.

Notes:

(1) Sprinkler discharge densities and areas of application are based on a maximum clearance of 10 ft (3.1 m) to maximum available height of storage. The maximum clearance is noted from actual testing and is not a definit

(2) Laced tires on-floor, vertical stacking on-side (typical truck tires), and off-road tires. Laced tires are not stc method due to the damage inflicted on the tire (i.e., bead).

(3) Water supply shall fulfill both requirements.

(4) Shelf storage of rubber tires shall be protected as solid rack shelving.

Table 18.4(b) Control Mode Density-Area Sprinklers System Density for Palletized Portable Rack Storage and Fixed Rack Storage of Rubber Tires with Pallets, Over 5 ft to 20 ft in Height

Storage Height	Sprinkler Temperature	
	High Temperature	Ordinary Temperature
>5 ft to 10 ft	0.32/2000	0.32/2000
>10 ft to 12 ft	0.39/2000	0.39/2600
>12 ft to 14 ft	0.45/2000	0.45/3200
>14 ft to 16 ft	0.5/2300	0.5/3700
>16 ft to 18 ft	0.55/2600	0.55/4400
>18 ft to 20 ft	0.6/3000	0.6/5000

**Palletized Portable Rack Storage and Fixed Rack Storage of Rubber
Tires with Pallets, Over 5 ft to 20 ft in Height**

Storage Height	Sprinkler Temperature	
	High Temperature	Ordinary Temperature

Table 18.4(c) Large Drop Sprinklers and Sprinkler Protection for

Piling Method	Pile Height	Number of Sprinklers and Minimum Operating Pressures (<i>see Note 2</i>)	Maxi
Rubber tire storage, on-side or on-tread, in palletized portable racks, or open portable racks, or fixed racks without solid shelves	Up to 25 ft (7.6 m)	15 sprinklers at 75 psi (5.2 bar) (<i>see Note 3</i>)	

Notes:

- (1) Wet systems only.
- (2) Sprinkler operating pressures and number of sprinklers in the design are based on tests in which the clear deflector and the maximum height of storage.
- (3) The design area shall consist of the most hydraulically demanding area of 15 sprinklers, consisting of five : include a minimum operating area of 1200 ft² (112 m²) and a maximum operating area of 1500 ft² (139 m²) a
- (4) Shelf storage of rubber tires shall be protected as solid rack shelving.

Table 18.4(d) Early Suppression Fast-Response (ESFR) Sprinklers for Protection of Rubber Tires

Piling Method	Pile Height	Maximum Building Height		Nominal K-factor	Orientation	Number of Sprinklers
		ft	m			
Rubber tire storage, on-side or on-tread, in palletized portable racks, open portable racks, or fixed racks without solid shelves	Up to 25 ft (7.6 m)	30	9.1	14.0 (201)	Upright or pendent	12 (see Notes)
				16.8 (242)	Upright/ Pendent	12 (see Notes)
				22.4 (322)	Pendent	12 (see Notes)
				25.2 (363)	Pendent	12 (see Notes)
Rubber tire storage, on-side, in palletized portable racks, open portable racks, or fixed racks without solid shelves	Up to 25 ft (7.6 m)	35	10.7	14.0 (201)	Upright or pendent	12 (see Notes)
				16.8 (242)	Pendent	12 (see Notes)
				22.4 (322)	Pendent	12 (see Notes)
				25.2 (363)	Pendent	12 (see Notes)
Laced tires in open portable steel racks	Up to 25 ft (7.6 m)	30	9.1	14.0 (201)	Pendent	20 (see Notes)
				16.8 (242)	Pendent	
Rubber tire storage, on-side, in palletized portable racks	Up to 25 ft (7.6 m)	40	12.2	14.0 (201)	Pendent	12
				16.8 (242)	Pendent	

Notes:

- (1) Wet systems only.
- (2) The shape of the design area shall be in accordance with 14.4.3 and 14.4.4.
- (3) Where used in this application, ESFR protection is expected to control rather than to suppress the fire.
- (4) The design area shall consist of the most hydraulically demanding area of 20 sprinklers, consisting of five : include a minimum operating area of 1600 ft² (149 m²).

18.5 In-Rack Sprinkler System Requirements for Protection of Rubber Tires.

18.5.1 In-rack sprinklers, where provided, shall be installed in accordance with Chapter 17, except as modified by 18.5.2 through 18.5.4.

18.5.2 The maximum horizontal spacing of sprinklers in rack shall be 8 ft (2.4 m).

18.5.3 Water demand for sprinklers installed in racks shall be based on simultaneous operation of the most hydraulically remote 12 sprinklers where only one level is installed in racks.

18.5.4 Sprinklers in racks shall discharge at not less than 30 psi (2.1 bar).

18.6 Reduced Discharge Density.

Where high-expansion foam systems are installed in accordance with NFPA 11, *Standard for Low-, Medium-, and High-Expansion Foam*, a reduction in sprinkler discharge density to one-half the density specified in Table 18.4(a) or 0.24 gpm/ft² (9.78 mm/min), whichever is higher, shall be permitted.

Chapter 19 Protection of Roll Paper

19.1* Protection of Roll Paper Storage.

19.1.1 General. The requirements of Chapter 12 shall apply unless modified by this chapter.

19.1.1.1 The water supply system for automatic fire protection systems shall be designed for a minimum duration of 2 hours.

19.1.1.1.1 For ESFR sprinklers, the water supply duration shall be 1 hour.

19.1.1.2 At least 500 gpm (1893 L/min) shall be added to the sprinkler demand for large and small hose stream allowance.

19.1.1.2.1 For ESFR sprinklers, the hose stream allowance shall be for 250 gpm (947 L/min).

19.1.1.3 The water supply design shall include the demand of the automatic sprinkler system plus the hose stream allowance plus, where provided, the high-expansion foam system.

19.1.1.4 Wet pipe systems shall be used in tissue storage areas.

19.1.1.5 Horizontal storage of heavyweight or mediumweight paper shall be protected as a closed array.

19.1.1.6 Mediumweight paper shall be permitted to be protected as heavyweight paper where wrapped completely on the sides and both ends, or where wrapped on the sides only with steel bands. Wrapping material shall be either a single layer of heavyweight paper with a basis weight of 40 lb (18.1 kg) or two layers of heavyweight paper with a basis weight of less than 40 lb (18.1 kg).

19.1.1.7 Lightweight paper or tissue paper shall be permitted to be protected as mediumweight paper where wrapped completely on the sides and both ends, or where wrapped on the sides only with steel bands. Wrapping material shall be either a single layer of heavyweight paper with a basis weight of 40 lb (18.1 kg) or two layers of heavyweight paper with a basis weight of less than 40 lb (18.1 kg).

19.1.1.8 For purposes of sprinkler system design criteria, lightweight class paper shall be

protected as tissue.

19.1.2* Protection Criteria for the Protection of Roll Paper Storage.

19.1.2.1 Control Mode Density–Area Sprinkler Protection Criteria for the Protection of Roll Paper Storage.

19.1.2.1.1 Storage of heavyweight or mediumweight classes of rolled paper up to 10 ft (3.1 m) in height shall be protected by sprinklers designed for ordinary hazard Group 2 densities.

19.1.2.1.2 Storage of tissue and lightweight classes of paper up to 10 ft (3.1 m) in height shall be protected by sprinklers in accordance with extra hazard Group 1 densities.

19.1.2.1.3 Sprinkler design criteria for storage of roll paper 10 ft (3.1 m) high and higher in buildings or structures with roof or ceilings up to 30 ft (9.1 m) shall be in accordance with Table 19.1.2.1.3(a) and Table 19.1.2.1.3(b).

Table 19.1.2.1.3(a) Control Mode Density–Area Sprinkler Protection Criteria for the Protection of Roll Paper Storage in Buildings or Structures with Roof or Ceilings Up to 30 ft (Discharge Densities)

Storage Height (ft)	Clearance (ft)	Heavyweight					Closed Array Banded or Unbanded	F
		Closed Array Banded or Unbanded	Standard Array		Open Array			
			Banded	Unbanded	Banded	Unbanded		
10	≤ 5	0.3/2000	0.3/2000	0.3/2000	0.3/2000	0.3/2000	0	
10	>5	0.3/2000	0.3/2000	0.3/2000	0.3/2000	0.3/2000	0	
15	≤ 5	0.3/2000	0.3/2000	0.3/2000	0.3/2500	0.3/3000	0.3/2000	0
15	>5	0.3/2000	0.3/2000	0.3/2000	0.3/3000	0.3/3500	0.3/2000	0
20	≤ 5	0.3/2000	0.3/2000	0.3/2500	0.45/3000	0.45/3500	0.3/2000	0.
20	>5	0.3/2000	0.3/2500	0.3/3000	0.45/3500	0.45/4000	0.3/2500	0.
25	≤ 5	0.45/2500	0.45/3000	0.45/3500	0.6/2500	0.6/3000	0.45/3000	0

Notes:

(1) Sprinkler protection requirements for tissue stored above 20 ft have not been determined.

(2) Densities or areas, or both, shall be permitted to be interpolated between any 5 ft storage height increment.

Table 19.1.2.1.3(b) Control Mode Density–Area Sprinkler Protection Criteria for the Protection of Roll Paper Storage in Buildings or Structures with Roof or Ceilings Up to 9.1 m (Discharge Densities)

Storage Height (m)	Clearance (m)	Heavyweight					Closed A Banded or Unbanded
		Closed Array Banded or Unbanded	Standard Array		Open Array		
			Banded	Unbanded	Banded	Unbanded	
3.1	≤ 1.5	12.2/185.8	12.2/185.8	12.2/185.8	12.2/185.8	12.2/185.8	12.2/18
3.1	>1.5	12.2/185.8	12.2/185.8	12.2/185.8	12.2/185.8	12.2/185.8	12.2/18
4.6	≤ 1.5	12.2/185.8	12.2/185.8	12.2/185.8	12.2/232.3	12.2/278.7	12.2/18

Table 19.1.2.1.3(b) Control Mode Density–Area Sprinkler Protection Criteria for the Structures with Roof or Ceilings Up to 9.1 m (Discharge Density)

Storage Height (m)	Clearance (m)	Heavyweight					Closed Array Banded or Unbanded
		Closed Array Banded or Unbanded	Standard Array		Open Array		
			Banded	Unbanded	Banded	Unbanded	
4.6	>1.5	12.2/185.8	12.2/185.8	12.2/185.8	12.2/278.7	12.2/322.2	12.2/18
6.1	≤1.5	12.2/185.8	12.2/185.8	12.2/232.3	18.3/278.7	18.3/325.2	12.2/18
6.1	>1.5	12.2/185.8	12.2/232.3	12.2/278.7	18.3/325.2	18.3/371.6	12.2/23
7.6	≤1.5	18.3/232.3	18.3/278.7	18.3/325.2	24.5/232.3	24.5/278.7	18.3/27

Notes:

- (1) Sprinkler protection requirements for tissue stored above 6.1 m have not been determined.
- (2) Densities or areas, or both, shall be permitted to be interpolated between any 1.5 m storage height increment.

19.1.2.1.4* High-temperature sprinklers shall be used for installations protecting roll paper stored 15 ft (4.6 m) or higher.

19.1.2.1.5 The protection area per sprinkler shall not exceed 100 ft² (9.3 m²) or be less than 70 ft² (6.5 m²).

19.1.2.1.6 Where high-expansion foam systems are installed in heavyweight class and mediumweight class storage areas, sprinkler discharge design densities can be reduced to not less than 0.24 gpm/ft² (9.8 mm/min) with a minimum operating area of 2000 ft² (186 m²).

19.1.2.1.7 Where high-expansion foam systems are installed in tissue storage areas, sprinkler discharge densities and areas of application shall not be reduced below those provided in Table 19.1.2.1.3(a) and Table 19.1.2.1.3(b).

19.1.2.2 Large Drop Sprinklers and Specific Application Control Mode Sprinklers for the Protection of Roll Paper Storage. Where automatic sprinkler system protection utilizes large drop sprinklers, hydraulic design criteria shall be as specified in Table 19.1.2.2. Design discharge pressure shall be 50 psi (3.4 bar). The number of sprinklers to be calculated is indicated based on storage height, clearance, and system type.

Table 19.1.2.2 Large Drop Sprinklers for the Protection of Roll Paper Storage

Storage Height		Clearance		System Type	Heavyweight					
					Closed Array	Standard Array		Open Array		Closed Array
ft	m	ft	m		Banded or Unbanded	Banded	Unbanded	Banded	Unbanded	Banded or Unbanded
20	6.1	<10	<3.1	W	15	15	15	15	NA	15
20	6.1	<10	<3.1	D	25	25	25	NA	NA	25
26	7.9	<34	<10.4	W	15	15	15	15	NA	NA
26	7.9	<34	<10.4	D	NA	NA	NA	NA	NA	NA

Table 19.1.2.2 Large Drop Sprinklers for the Protection of Roll Paper Storage

Storage Height		Clearance		System Type	Heavyweight					
					Closed Array	Standard Array		Open Array		Closed Array
ft	m	ft	m		Banded or Unbanded	Banded	Unbanded	Banded	Unbanded	Banded or Unbanded

W: Wet. D: Dry. NA: Not applicable.

Notes:

(1) For definition of storage height, see 3.9.2.

(2) Twenty-five large drop sprinklers @ 75 psi (5.2 bar) for closed or standard array; other arrays NA.

19.1.2.3 Early Suppression Fast-Response (ESFR) Sprinklers for the Protection of Roll Paper Storage. Where automatic sprinkler system protection utilizes ESFR sprinklers, hydraulic design criteria shall be as specified in Table 19.1.2.3. Design discharge pressure shall be applied to 12 operating sprinklers.

Table 19.1.2.3 ESFR Sprinklers for the Protection of Roll Paper Storage (Max

ESFR K-Factor	Orientation	System Type	Pressure		Building Height		Heavyweight					
							Closed		Standard		Open	
			psi	bar	ft	m	ft	m	ft	m	ft	m
14.0 (201)	Upright or pendent	wet	50	3.4	30	9.1	25	7.6	25	7.6	25	
16.8 (242)	Upright/Pendent	Wet	35	2.4								
22.4 (322)	Pendent	Wet	25	1.7								
25.2 (363)	Pendent	Wet	15	1.0								
14.0 (201)	Upright or pendent	Wet	75	5.2	35	10.7	30	9.1	30	9.1	30	
16.8 (242)	Upright/Pendent	Wet	52	3.6								
14.0 (201)	Pendent	Wet	75	5.2	40	12.2	30	9.1	30	9.1	30	
16.8 (242)	Pendent	Wet	52	3.6								
22.4 (322)	Pendent	Wet	40	2.8								
25.2 (363)	Pendent	Wet	25	1.7								
22.4 (322)	Pendent	Wet	50	3.4	45	13.7	30	9.1	30	9.1	30	

Table 19.1.2.3 ESRF Sprinklers for the Protection of Roll Paper Storage (Max

ESFR K-Factor	Orientation	System Type	Pressure		Building Height		Heavyweight					
							Closed		Standard		O	
			psi	bar	ft	m	ft	m	ft	m	ft	m
25.2 (363)	Pendent	Wet	50	3.4	45	13.7	50	9.1	50	9.1	50	

Chapter 20 Special Designs of Storage Protection

20.1 General.

The requirements of Chapter 12 shall apply unless modified by this chapter.

20.2* Plastic Motor Vehicle Components.

Plastic automotive components and associated packaging material shall be permitted to be protected in accordance with Table 20.2.

Table 20.2 K-25.2 (363) ESRF Sprinkler Design Criteria for Portable Racks (Close Automotive Components

Commodity	Maximum Storage Height		Maximum Ceiling/Roof Height		Type of System	Maximum Sprinkler Spacing ^b		Number of Des Sprinklers by Minimum Oper Pressure ^c	
	ft	m	ft	m		ft ²	m ²	psi	bar
Automotive components and associated packaging material	25	7.6	35	10.7	Wet	100	9.3	16 at 37 psi	16 at 2.5 bar

^aPortable rack array shall be tightly nested without any flue spaces.

^bSprinkler spacing can exceed 100 ft² (9.3 m²) where sprinklers are listed for larger spacing.

^cSystem hydraulic design shall also be capable of delivering a discharge density of 0.60 gpm/ft² over the most

^dMaximum deflector distance below ceiling shall be permitted to exceed 18 in.² where sprinklers are listed for

20.3* Sprinkler Design Criteria for Storage and Display of Class I Through Class IV Commodities, Cartoned Non-Expanded Group A Plastics, and Non-Expanded Exposed Group A Plastics in Retail Stores.

20.3.1 A wet pipe system designed to meet two separate design points — 0.6 gpm/ft² (24.4 mm/min) density over 2000 ft² (186 m²) and 0.7 gpm/ft² (28.5 mm/min) density for the four

Copyright NFPA

hydraulically most demanding sprinklers with 500 gpm (1893 L/min) hose stream allowance for a 2 hour duration — shall be permitted to protect single- and double-row slatted shelf racks when the following conditions are met:

- (1) An extended coverage sprinkler with a nominal K-factor of K-25.2 (363) listed for storage occupancies shall be provided.
- (2) Shelves shall be slatted using a 2 in. (50 mm) thick by maximum 6 in. (152 mm) wide slat held in place by spacers that maintain a minimum 2 in. (50 mm) opening between each slat.
- (3) There shall be no slatted shelf levels in the rack above nominal 12 ft (3.66 m) level. Wire mesh (greater than 50 percent opening) shall be permitted for shelf levels above 12 ft (3.66 m).
- (4) Solid plywood shelving (3½ ft × 8 ft 3 in.) (1.07 m by 2.51 m) shall be permissible over the wood slats at the 5 ft (1.52 m) level.
- (5) Perforated metal (open area of 40 percent or more) shall be permitted over the slatted shelves up to the 60 in. (1.52 m) level.
- (6) Other than what is allowed in this section, solid plywood or similar materials shall not be placed on the slatted shelves.
- (7) Solid veneered particleboard displays shall be permissible, provided that all flues are maintained and only one display is installed per bay.
- (8) Maximum roof height shall be 30 ft (9.14 m) in the protected area.
- (9) Maximum storage height shall be 22 ft (6.71 m).
- (10) Aisle widths shall be a minimum of 8 ft (2.44 m).
- (11) Minimum transverse flue spaces of 3 in. every 10 ft (76 mm every 3.05 m) horizontally shall be provided.
- (12) Minimum longitudinal flue spaces of 6 in. (152 mm) shall be provided for double-row racks.
- (13) Storage in the aisle shall be permissible, provided the aisle storage is no more than 4 ft (1.22 m) high and a minimum clear aisle of 4 ft (1.22 m) is maintained.

20.3.2 A wet pipe system designed to meet two separate design points — 0.425 gpm/ft² (17.3 mm/min) density over 2000 ft² (186 m²) and 0.50 gpm/ft² (20.4 mm/min) density for the four hydraulically most demanding sprinklers with 500 gpm (1893 L/min) hose stream allowance for a 2 hour duration — shall be permitted in solid steel cantilever style retail shelving racks (gondola racks) when the following conditions are met:

- (1) An extended coverage sprinkler with a nominal K-factor of K-25.2 (363) listed for storage occupancies shall be provided.
- (2) The storage height shall not exceed 12 ft (3.66 m).
- (3) The ceiling height shall not exceed 22 ft (6.71 m) in the protected area.

- (4) Gondola rack structure shall not exceed 48 in. (1.22 m) in aggregate depth or 78 in. (1.99 m) in height.
- (5) A minimum aisle of 5 ft (1.52 m) between storage shall be maintained.
- (6) Rack lengths shall be no more than 70 ft (21.3 m).

20.3.3 A wet system designed to meet two separate design points — 0.425 gpm/ft² (17.3 mm/min) density over 2000 ft² (186 m²) and 0.50 gpm/ft² (20.4 mm/min) density for the four hydraulically most demanding sprinklers with 500 gpm (1893 L/min) hose stream allowance for a 2 hour duration — shall be permitted in solid steel cantilever-style retail shelving racks (gondola racks) when the following conditions are met:

- (1) An extended coverage sprinkler with a nominal K-factor of K-25.2 (363) listed for storage occupancies shall be provided.
- (2) Storage height shall not exceed 15 ft (4.57 m).
- (3) Ceiling height shall not exceed 25 ft (7.62 m) in the protected area.
- (4) Gondola rack structure shall not exceed 60 in. (1.52 m) in aggregate depth or 8 ft (2.44 m) in height.
- (5) A perforated metal deck at the 8 ft (2.44 m) level shall be permissible with storage placed on top with or without flue spaces to a maximum height from floor of 15 ft (4.57 m).
- (6) Rack lengths shall not exceed 70 ft (21.3 m).
- (7) A minimum aisle space of 6 ft (1.83 m) shall be provided.

20.3.4 A wet pipe system designed to meet two separate design points — 0.45 gpm/ft² (17.3 mm/min) density over 2000 ft² (186 m²) and 0.55 gpm/ft² (22.4 mm/min) density for the four hydraulically most demanding sprinklers with 500 gpm (1893 L/min) hose stream allowance for a 2 hour duration — shall be permitted without the use of in-rack sprinklers when the following are met:

- (1) An extended coverage sprinkler with a nominal K-factor of K-25.2 (363) listed for storage occupancies shall be provided.
- (2) Storage height shall not exceed 15 ft (4.57 m).
- (3) Ceiling height shall not exceed 20 ft 6 in. (6.25 m).
- (4) Shelving structure shall not exceed 48 in. (1.22 mm) aggregate depth or 12 ft (3.66 m) in height.
- (5) Shelving shall be permitted to be made of solid particleboard.
- (6) A minimum aisle space of 3 ft (914 mm) shall be maintained.
- (7) Shelving length shall be a maximum of 70 ft (21.3 m).

20.3.5 A wet pipe system designed to meet two separate design points — 0.38 gpm/ft² (15.5 mm/min) density over 2000 ft² (186 m²) and 0.45 gpm/ft² (17.3 mm/min) density for

the four hydraulically most demanding sprinklers with 500 gpm (1893 L/min) hose stream allowance for a 2 hour duration — shall be permitted without the use of in-rack sprinklers in steel retail sales floor shelving racks where the following conditions are met:

- (1) An extended coverage sprinkler with a nominal K-factor of K-25.2 (363) listed for storage occupancies shall be provided.
- (2) Storage height shall not exceed 14 ft (4.27 m).
- (3) Ceiling height shall not exceed 20 ft (6.1 m).
- (4) Solid metal shelving shall be permissible up to the 72 in. (1.83 m) level and wire shelving shall be permissible up to the 10 ft (3.05 m) level.
- (5) The solid metal shelving shall not exceed 66 in. (1.68 m) in aggregate depth with a 6 in. (152 mm) longitudinal flue between two 30 in. (762 mm) deep shelves.
- (6) A minimum aisle space of 5 ft (1.52 m) shall be maintained.
- (7) A minimum longitudinal flue of 6 in. (152 mm) shall be maintained.
- (8) Rack length shall be a maximum of 70 ft (21.3 m).

20.3.6 A wet pipe system designed to meet two separate design points — 0.49 gpm/ft² (20 mm/min) density over 2000 ft² (186 m²) and 0.55 gpm/ft² (22.4 mm/min) density for the four hydraulically most demanding sprinklers with 500 gpm (1893 L/min) hose stream allowance for a 2 hour duration — shall be permitted without the use of in-rack sprinklers in retail solid shelved steel rack structure when the following conditions are met:

- (1) An extended coverage sprinkler with a nominal K-factor of K-25.2 (363) listed for storage occupancies shall be provided.
- (2) Storage height shall not exceed 16.5 ft (5.03 m).
- (3) Ceiling height shall not exceed 22 ft (6.71 m).
- (4) Shelving structure shall not exceed 51 in. (1.3 m) aggregate depth or 148 in. (3.76 m) in height.
- (5) The intersection of perpendicular steel racks shall be permissible as long as no storage is placed within the void space at the junction of the racks.
- (6) The top shelf shall be wire mesh.
- (7) A minimum aisle width of 4 ft (1.22 m) shall be maintained between shelf units and other displays.

20.4 Protection of Baled Cotton Storage.

20.4.1 General. The requirements of Chapter 12 shall apply unless modified by this chapter.

20.4.1.1 The total water supply available shall be sufficient to provide the recommended sprinkler discharge density over the area to be protected, plus a minimum of 500 gpm (1893 L/min) for hose streams.

20.4.1.2 Water supplies shall be capable of supplying the total demand for sprinklers and hose streams for not less than 2 hours.

20.4.2 Control Mode Density–Area Sprinkler Protection Criteria for Baled Cotton Storage.

20.4.2.1 For tiered or rack storage up to a nominal 15 ft (4.6 m) in height, sprinkler discharge densities and areas of application shall be in accordance with Table 20.4.2.1.

Table 20.4.2.1 Baled Cotton Storage Up to and Including 15 ft (4.6 m)

System Type	Baled Cotton Storage Up to and Including 15 ft		
	Tiered Storage	Rack Storage	Untiered Storage
Wet	0.25/3000	0.33/3000	0.15/3000
Dry	0.25/3900	0.33/3900	0.15/3900

20.4.2.2 Where roof or ceiling heights would prohibit storage above a nominal 10 ft (3.1 m), the sprinkler discharge density shall be permitted to be reduced by 20 percent of that indicated in Table 20.4.2.1 but shall not be reduced to less than 0.15 gpm/ft² (6.1 mm/min).

Chapter 21 Special Occupancy Requirements

21.1 General.

21.1.1 Application.

21.1.1.1 In addition to the requirements of Chapter 8, and Chapter 11 through 21 and Chapter 22, the following special occupancy requirements shall apply. All provisions of design criteria in this standard, including design area increases and reductions, shall also apply to these special occupancy requirements.

21.1.1.2 Where the requirements of the reference standard differ from the requirements of this standard, the reference standard shall take precedence.

21.1.2 Definitions. For terms not defined in Chapter 3, the definitions of the reference standard shall apply.

21.2 Flammable and Combustible Liquids.

21.2.1 Design Requirements. Sprinkler system discharge criteria for the protection of flammable and combustible liquids shall comply with NFPA 30, *Flammable and Combustible Liquids Code*.

21.2.2 Installation Requirements. (Reserved)

21.3 Aerosol Products.

21.3.1 Design Requirements. Sprinkler system discharge criteria for the protection of aerosol products shall comply with NFPA 30B, *Code for the Manufacture and Storage of Aerosol Products*.

21.3.2 Installation Requirements. (Reserved)

21.4 Standard for Spray Application Using Flammable or Combustible Materials.

21.4.1 Design Requirements.

21.4.1.1* The automatic sprinkler system shall be a wet pipe system, a dry pipe system, a preaction system, or an open-head deluge system, whichever is most appropriate for the portion of the spray operation being protected. [33:9.4.1]

21.4.1.2 The automatic sprinkler system shall be designed for Extra Hazard (Group 2) occupancies.

Exception:

For spray application of styrene cross-link thermoset resins, Section 17.3 of NFPA 33 shall apply.

[33:9.4.2]

21.4.1.3 The water supply shall be sufficient to supply all sprinklers likely to open in any one fire incident without depleting the available water for use in hose streams. [33:9.4.3]

21.4.1.4 Where sprinklers are installed to protect spray areas and mixing rooms only, water shall be permitted to be supplied from domestic water systems provided the domestic supply can meet the design criteria of 21.4.1.2. [33:9.4.4]

21.4.1.5 The sprinkler system for each spray area and mixing room shall be controlled by a separate, listed indicating valve(s), operable from the floor. [33:9.4.5]

21.4.1.6 Resin application areas shall be protected by an automatic sprinkler system that is designed for at least ordinary hazard (Group 2) occupancies. [33:17.3]

21.4.2 Installation Requirements.

21.4.2.1* Sprinklers protecting spray areas and mixing rooms shall be protected against overspray residue, either by location or covering, so that they will operate quickly in event of fire. [33:9.4.7]

21.4.2.2 Sprinklers shall be permitted to be covered only by cellophane bags having a thickness of 0.003 in. (0.08 mm) or less or by thin paper bags. These coverings shall be replaced frequently so that heavy deposits of residue do not accumulate. [33:9.4.7.1]

21.5 Solvent Extraction Plants.

21.5.1* Design Requirements.

21.5.2 Installation Requirements. (Reserved)

21.6 Installation and Use of Stationary Combustion Engines and Gas Turbines.

21.6.1* Design Requirements. Automatic sprinkler systems shall be designed to provide for a density of 0.3 gpm/ft² (12.2 L/min/m²) over the most remote 2500 ft² (230 m²). [37:11.4.5.1]

21.6.2 Installation Requirements.

21.6.2.1 Sprinklers shall be spaced at a 100 ft² (9 m²) maximum. [37:11.4.5.1.1]

21.6.2.2 System coverage shall be provided to all areas within the enclosure located within 20 ft (6 m) of the engine, lubricating oil system, or fuel system. [37:11.4.5.1.2]

21.6.2.3 Sprinklers and water spray nozzles shall not be directed at engine components that are susceptible to thermal shock or deformation. [37:11.4.5.2]

21.7 Nitrate Film.

21.7.1 Design Requirements.

21.7.1.1 Every room, except projection booths and rewinding rooms, where nitrate film is stored or handled in quantities greater than 51 lb (23 kg), or 10 standard rolls, shall be protected by an automatic sprinkler system that is designed in accordance with the requirements for Group II extra hazard occupancies. [40:5.1.2]

21.7.1.2 Water supplies for automatic sprinklers shall be based on 20 gpm (1.26 L/sec) per sprinkler for 20 minutes for the total number of sprinklers in one vault plus 25 percent of the sprinklers in the communicating fire area. [40:5.2.2]

21.7.2 Installation Requirements.

21.7.2.1 In areas or rooms where nitrate film is handled, the area that is protected per sprinkler shall not exceed 64 ft² (6 m²) with sprinklers and branch lines not being more than 8 ft (2.4 m) apart. [40:5.1.4]

21.7.2.2 Cabinet Protection. [40:6.2.5]

21.7.2.2.1 Cabinets having a capacity of more than 34 kg (75 lb), or 15 standard rolls, of film shall be provided with at least one automatic sprinkler head. [40:6.2.5.1]

21.7.2.2.2 Where cans are stored on more than one shelf, as shown in Figure 21.7.2.2.2 and as described in 6.2.6.2 or 6.2.6.3 of NFPA 40, *Standard for the Storage and Handling of Cellulose Nitrate Film*, one sprinkler shall be provided for each shelf. [40:6.2.5.2]

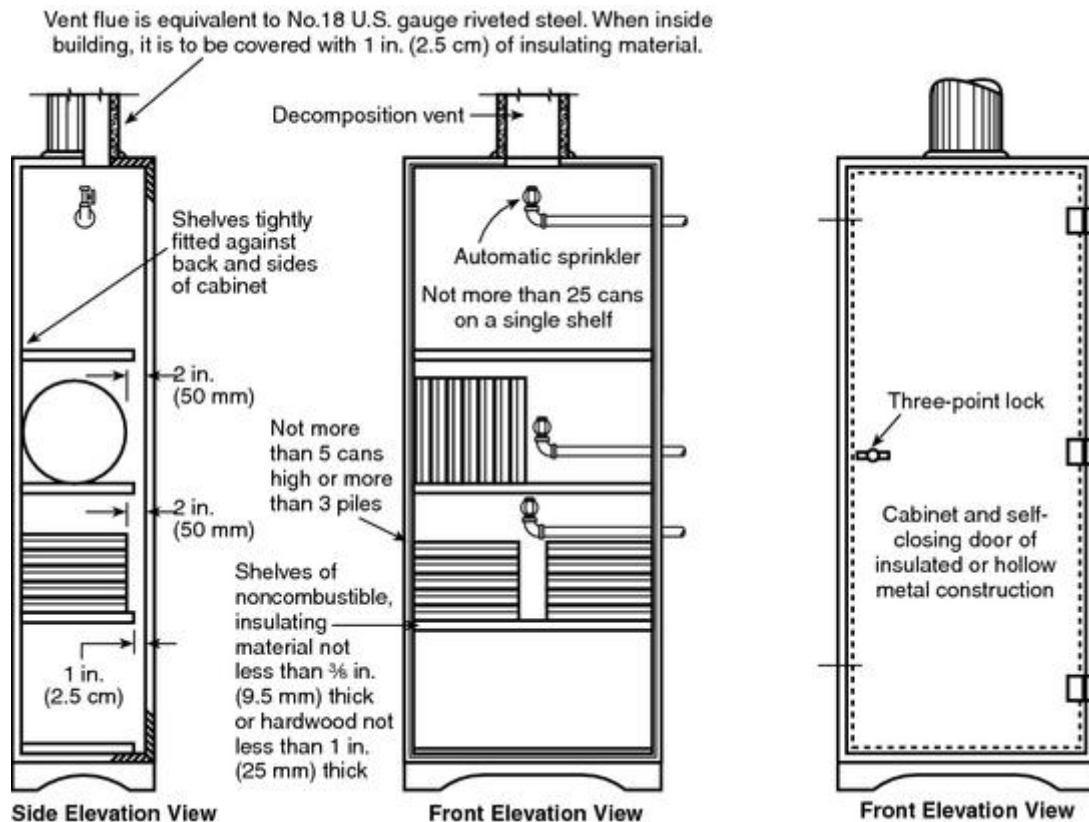

FIGURE 21.7.2.2.2 Standard Film Cabinet for Other Than Extended Term Storage Film. [40:Figure 6.2.1]

21.7.2.3* Vaults Other Than Extended Term Storage Vaults. [40:6.3] (See Figure A.21.7.2.3.)

21.7.2.3.1 Sprinkler protection utilizing regular automatic sprinklers or open sprinklers shall be calculated on the basis of one sprinkler for each 62.5 ft³ (1.8 m³) of the interior vault volume. [40:6.3.7.1]

21.7.2.3.2 The minimum number of sprinklers for a standard 750 ft³ (21 m³) vault shall be not less than 12. [40:6.3.7.2]

21.7.2.3.3* Sprinklers or nozzles shall be arranged to provide coverage over the tops and fronts of shelves. [40:6.3.7.3]

21.7.2.3.4 Where automatic sprinklers are used, barriers made of No. 24 U.S. gauge sheet steel or other acceptable noncombustible material shall be installed between each sprinkler. Barriers shall be fastened rigidly in place and shall extend from the ceiling down to 4 in. (100 cm) below the sprinkler deflectors. [40:6.3.7.4]

21.7.2.4 Extended Term Storage Vaults. (See Figure 21.7.2.4.)

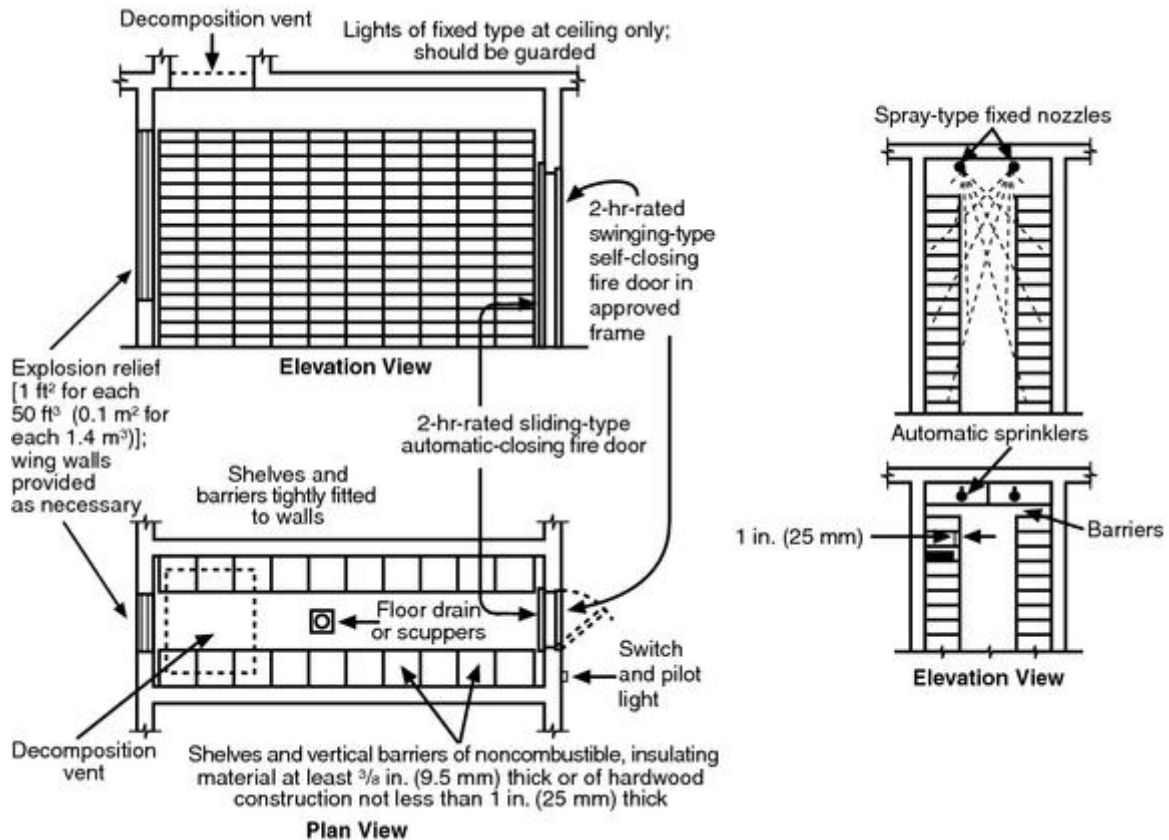

FIGURE 21.7.2.4 Extended Term Storage Vault. [40:Figure A.6.5]

21.7.2.4.1 Sprinklers shall be provided in a ratio of one head for each 63.6 ft³ (1.8 m³) of vault volume.

Exception:

Sprinkler systems in existing extended term storage vaults that were in compliance with the provisions of NFPA 40, Standard for the Storage and Handling of Cellulose Nitrate Film, at the time of installation shall be permitted to be continued in use. [40:6.5.6.1]

21.7.2.4.2 The minimum number of sprinkler heads for a 1000 ft³ (28 m³) vault shall be 15 sprinklers.

Exception:

Sprinkler systems in existing extended term storage vaults that were in compliance with the provisions of NFPA 40, Standard for the Storage and Handling of Cellulose Nitrate Film, at the time of installation shall be permitted to be continued in use. [40:6.5.6.2]

21.7.2.4.3 Directional sprinkler heads that will provide coverage into the face of the shelves shall be provided. [40:6.5.6.3]

21.7.2.5 Motion Picture Film Laboratories. In all cases, sprinklers shall be arranged so that not more than two machines are protected by any one sprinkler head. [40:9.2.5.2]

21.8 Storage of Pyroxylin Plastic.

Copyright NFPA

21.8.1 Design Requirements.

21.8.1.1 The water supply for automatic sprinklers shall be based on the number of sprinklers liable to be affected in any fire section between fire walls or fire-resistive partitions. It shall be assumed that any of the following numbers of sprinklers can be affected and the condition giving maximum flow used as a basis:

- (1) All sprinklers in a vault
- (2) All sprinklers in a tote box storeroom
- (3) Three-fourths of the sprinklers in a finished-stock storeroom
- (4) All sprinklers in a section of an isolated storage building [42:4.4.3.1]

21.8.1.2 The water supply for an automatic sprinkler system shall be based on a flow of 20 gpm (76 Lpm) per sprinkler for 20 minutes, with a minimum rate of flow of 500 gpm (1900 Lpm). Such flow shall be with an effective pressure at the top line of sprinklers of not less than 40 psi (276 kPa). [42:4.4.3.2]

21.8.2 Installation Requirements. See Figure 21.8.2(a) and Figure 21.8.2(b).

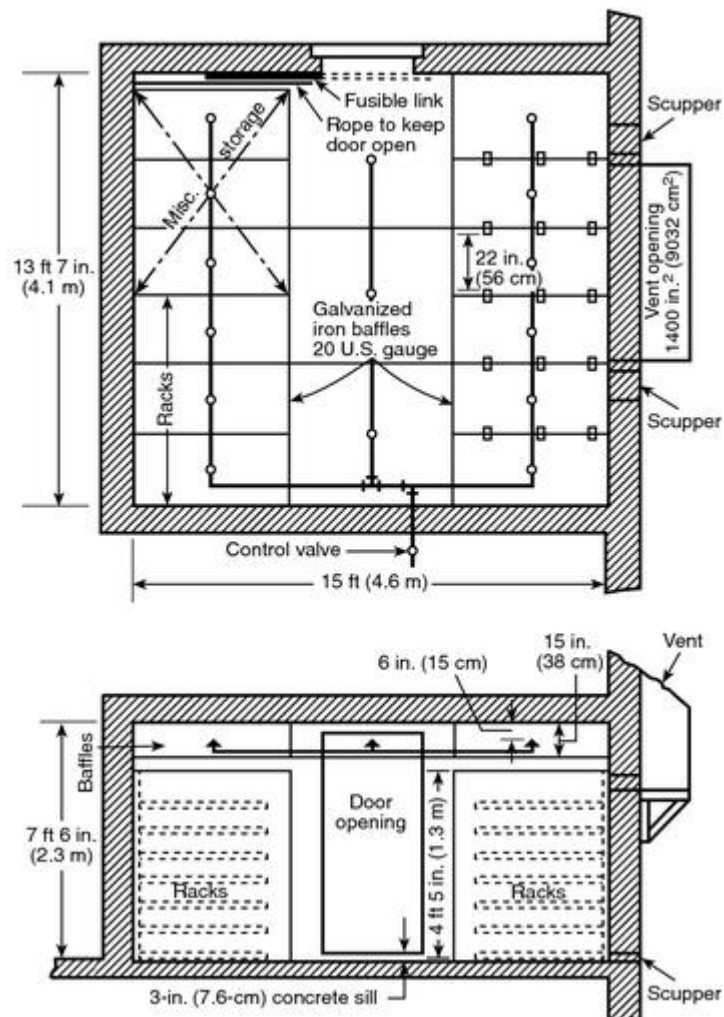

FIGURE 21.8.2(a) Raw Stock Storage Vault Showing General Arrangement of Sprinklers, Racks, and Baffles. [42:Figure 6.3.3.7(a)]

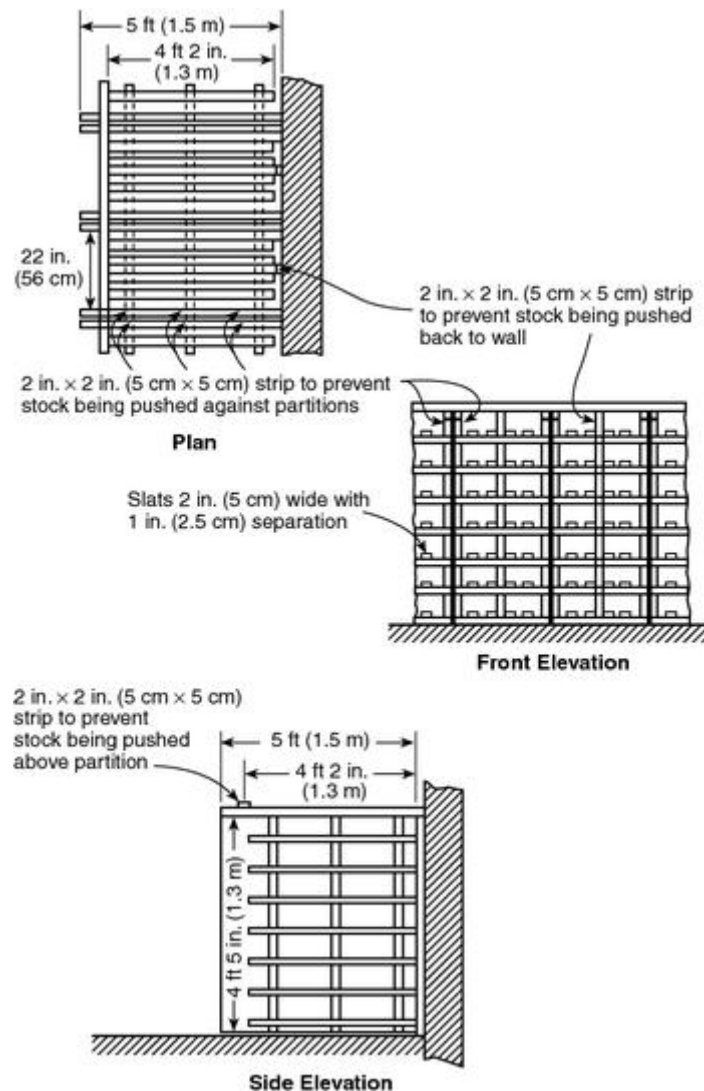

FIGURE 21.8.2(b) Details of Storage Racks in Raw Stock Storage Vault. [42:Figure 6.3.3.7(b)]

21.8.2.1 Where sprinkler systems are provided for isolated storage buildings per 5.4.3 of NFPA 42, *Code for the Storage of Pyroxylin Plastic*, sprinklers shall be spaced so that there is one sprinkler per 32 ft² (3 m²). [42:5.4.3]

21.8.2.2 Sprinklers in buildings used for storage of loose scrap shall be installed in the ratio of one sprinkler for each 1000 lb (454 kg) of storage.

Exception:

The ratio in 21.8.2.2 shall not apply if the scrap is in tanks or other receptacles kept filled with water. [42:5.4.4]

21.8.2.3 Cabinets holding over 50 lb (23 kg) of pyroxylin plastic shall be equipped with at

least one automatic sprinkler. If divided into two or more compartments, they shall have at least one automatic sprinkler in each compartment. [42:6.2.10]

21.8.2.4 Vaults Containing Pyroxylin Plastic.

21.8.2.4.1 Vaults shall be equipped with automatic sprinklers in a ratio of one sprinkler to each 834 lb (378 kg) of pyroxylin plastic or one sprinkler to each 125 ft³ (3.5 m³) of total vault space. [42:6.4.1]

21.8.2.4.2 A vault that is divided into two or more sections shall have at least one automatic sprinkler in each section. [42:6.4.2]

21.8.2.4.3 Cabinets holding over 50 lb (23kg) of pyroxylin plastic shall be equipped with at least one automatic sprinkler. If divided into two or more compartments, they shall have at least one automatic sprinkler in each compartment. [42:6.4.5]

21.8.2.5 Tote-Box Storeroom for Pyroxylin Plastic. Sprinkler protection provided for the tote box storeroom shall consist of one sprinkler in the center of the aisle immediately in front of the dividing partition between each pair of sections. Proper baffles shall be provided between heads. [42:6.7.9] *[See Figure 21.8.2.5(a) and Figure 21.8.2.5(b).]*

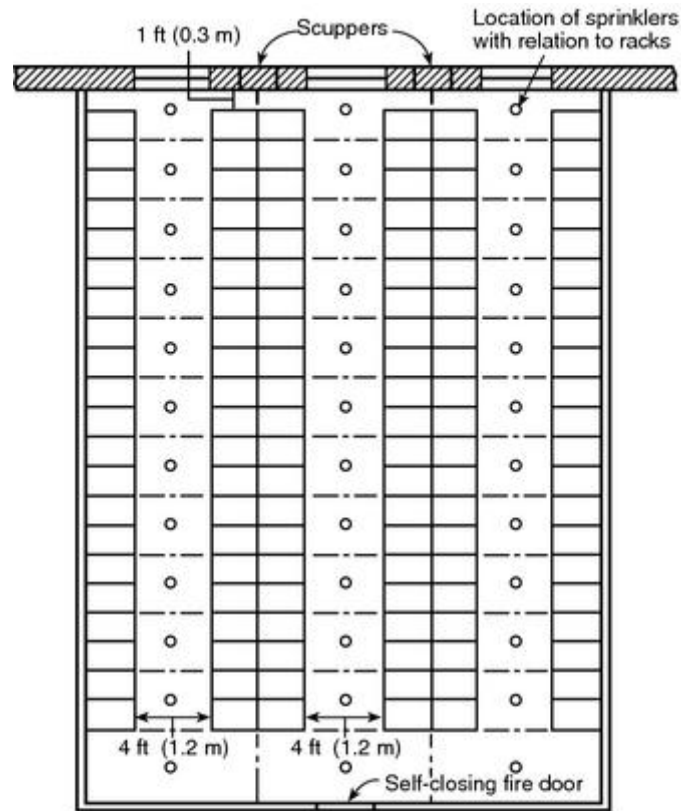

Plan

Total area of storeroom not to exceed 1000 ft² (93 m²)

Dimensions of racks, distance between baffles, and other dimensions will vary with the size of tote box

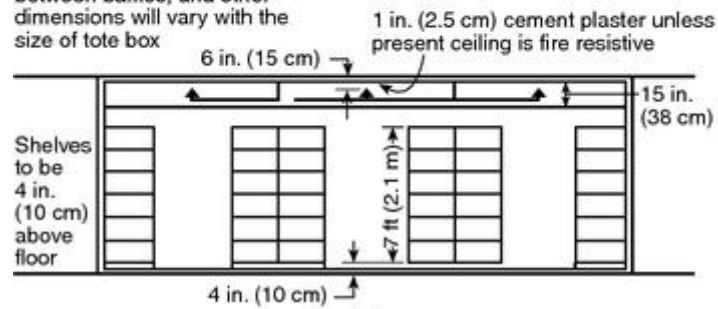

Elevation

FIGURE 21.8.2.5(a) Tote Box Storeroom Showing General Arrangement of Racks and Sprinklers. [42:Figure 6.7]

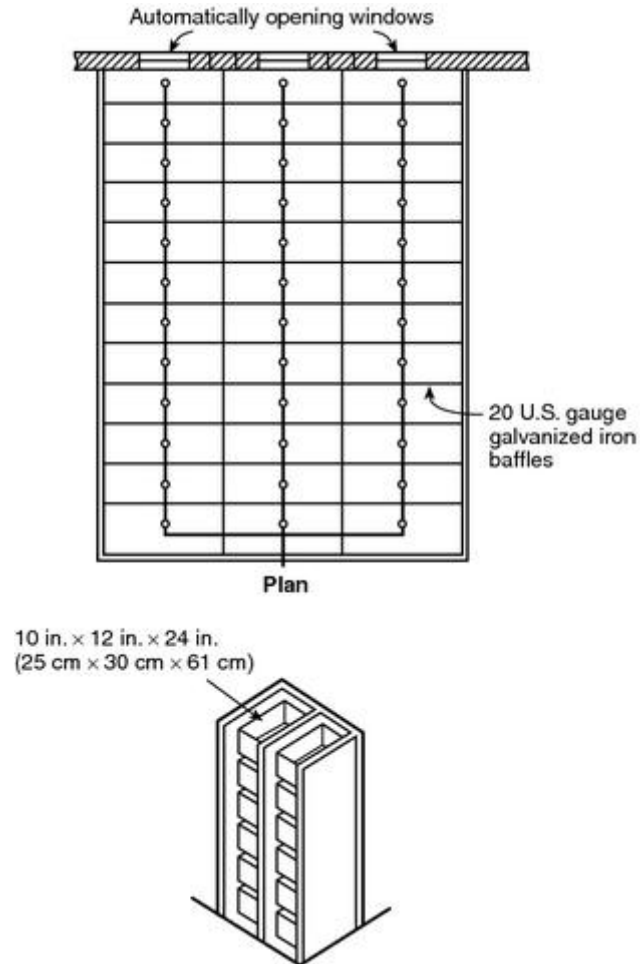

FIGURE 21.8.2.5(b) Tote Box Storeroom Showing Arrangement of Sprinklers and Baffles and Section of Tote Box Storage Rack. [42:Figure 6.7.7]

21.8.2.6 Finished Stock Storeroom for Pyroxylin Plastic. See Figure 21.8.2.6.

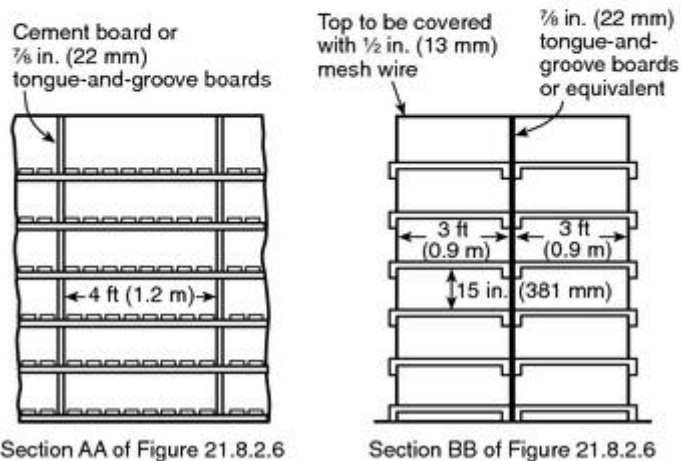
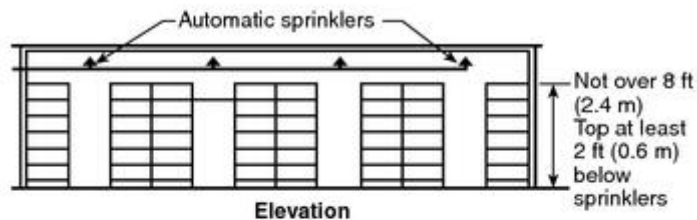
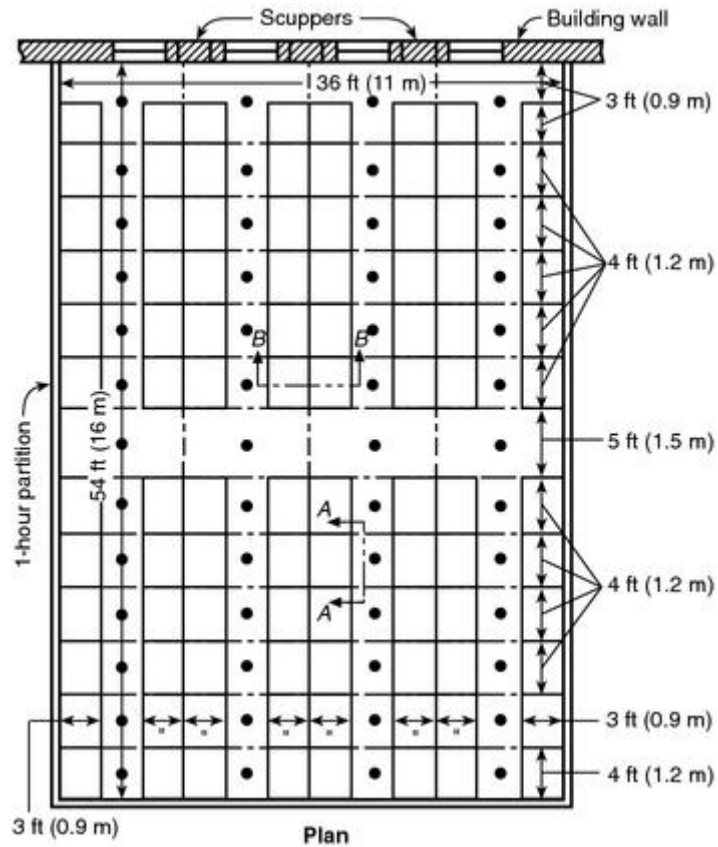

FIGURE 21.8.2.6 Finished-Stock Storeroom Showing General Arrangement of Racks.
 [42:Figure 6.8(a)]

21.8.2.6.1 Automatic sprinklers shall be installed with proper baffles between sprinklers in

the center of the aisle opposite each section. [42:6.8.7]

21.8.2.6.2 Special Rooms for Stock in Shipping Cases. The special room shall be protected by automatic sprinklers, with at least one sprinkler for each 64 ft² (6 m²). [42:6.9.4]

21.9 Laboratories Using Chemicals.

21.9.1 Design Requirements.

21.9.1.1 An automatic sprinkler system protection shall be required for all new laboratories in accordance with the following:

- (1) Automatic sprinkler system protection for Class A and Class B laboratories shall be in accordance with ordinary hazard (Group 2) occupancies.
- (2) Automatic sprinkler system protection for Class C and Class D laboratories shall be in accordance with ordinary hazard (Group 1) occupancies. [45:6.2.1.1]

21.9.2 Installation Requirements. (Reserved)

21.10 Oxygen-Fuel Gas Systems for Welding, Cutting, and Allied Processes.

21.10.1 Design Requirements.

21.10.1.1 The total gas capacity of acetylene or nonliquefied flammable gas in one storage area shall be permitted to be increased to 141.5 m³ (5000 ft³) in cylinder storage areas that are protected by an automatic sprinkler system and water supply designed in accordance with NFPA 13, *Standard for the Installation of Sprinkler Systems*, furnishing a sprinkler discharge density of at least (10 L/min)/m² [(0.25 gal/min)/ft²] over a minimum operating area of at least 297 m² (3000 ft²) with sprinklers located not more than 6.1 m (20 ft) above the floor where the cylinders are stored. [51:4.3.2]

21.10.2 Installation Requirements.

21.10.2.1 In buildings protected by an automatic sprinkler system and water supply designed in accordance with NFPA 13, *Standard for the Installation of Sprinkler Systems*, for an ordinary hazard or more hazardous occupancy, where the occupancy other than the cylinder storage is not more hazardous than ordinary hazard as defined in NFPA 13, the distance between storage areas shall be permitted to be reduced to 15.2 m (50 ft). If the occupancy in such protected buildings between the storage areas is free of combustible material, the distance shall be permitted to be reduced to 7.6 m (25 ft). [51:4.3.4]

21.11 Acetylene Cylinder Charging Plants.

21.11.1 Design Requirements.

21.11.1.1 Where an automatic sprinkler system is required per NFPA 51A, *Standard for Acetylene Cylinder Charging Plants*, it is permitted to be an extra hazard (Group 1) open or closed head sprinkler system. [51A:9.2.2]

21.11.2 Installation Requirements. (Reserved)

21.12 Storage, Use, and Handling of Compressed Gases and Cryogenic Fluids in Portable and Stationary Containers, Cylinders, and Tanks.

21.12.1 Design Criteria.

21.12.1.1 When sprinkler protection is provided for areas in which compressed gases or cryogenic fluids are stored or used, the system shall be designed for ordinary hazard, Group 2, with a minimum design area of 3000 ft² (278.7 m²). [55:6.10.2.1]

21.12.1.2 When sprinkler protection is provided for areas in which the flammable or pyrophoric compressed gases or cryogenic fluids are stored or used, the system shall be designed for extra hazard, Group 1, with a minimum design area of 2500 ft² (232.25 m²). [55:6.10.2.2]



21.12.2 Installation Requirements. (Reserved)

21.13 Utility LP-Gas Plants.

21.13.1 Design Requirements.

21.13.1.1 The design of fire water supply and distribution systems, if required by NFPA 59, *Utility LP-Gas Plant Code*, shall provide for the simultaneous supply of those fixed fire protection systems involved in the maximum single incident expected in the plant, including monitor nozzles, at their design flow and pressure. An additional supply of 1000 gal/min (63 L/sec) shall be available for hand hose streams for a period of not less than 2 hours. Manually actuated monitors shall be permitted to be used to augment hand hose streams. [59:13.4.2]

21.13.2 Installation Requirements. (Reserved)

21.14 Production, Storage, and Handling of Liquefied Natural Gas (LNG).

21.14.1 Design Requirements. The fire water supply and distribution systems, if required by NFPA 59A, *Standard for the Production, Storage, and Handling of Liquefied Natural Gas (LNG)*, shall simultaneously supply water to fixed fire protection systems, including monitor nozzles, at their design flow and pressure, involved in the maximum single incident expected in the plant plus an allowance of 1000 gpm (63 L/sec) for hand hose streams for not less than 2 hours. [59A:12.5.2]

21.14.2 Installation Requirements. (Reserved)

21.15 Protection of Information Technology Equipment.

21.15.1 Design Requirements. (Reserved)

21.15.2 Installation Requirements.

21.15.2.1 Sprinkler systems protecting information technology equipment areas shall be valved separately from other sprinkler systems. [75:8.1.3]

21.16 Standard on Incinerators, and Waste and Linen Handling Systems and

Equipment.

21.16.1 Design Requirements. (Reserved)

21.16.2 Installation Requirements.

21.16.2.1* Waste and Linen Chutes and Transport Systems. [82:5]

21.16.2.1.1 Gravity Linen Chute. [82:5.2.6.1]

21.16.2.1.1.1 Gravity chutes shall be protected internally by automatic sprinklers.
[82:5.2.6.1.1]

21.16.2.1.1.2 This protection requires that a sprinkler be installed at or above the top service opening of the chute. [82:5.2.6.1.2]

21.16.2.1.1.3 Chute Sprinkler Protection. Automatic sprinklers installed in gravity chute service openings shall be recessed out of the chute area through which the material travels.
[82:5.2.6.1.3]

21.16.2.1.1.4 In addition, a sprinkler shall be installed within the chute at alternate floor levels in buildings over two stories in height, with a mandatory sprinkler located at the lowest service level. [82:5.2.6.1.4]

21.16.2.1.2 Chute Room Automatic Sprinklers. Automatic sprinklers shall be installed in chute terminal rooms. [82:5.2.7.2]

21.16.2.1.3 Gravity Pneumatic Trash or Linen Conveying Systems. [82:5.4]

21.16.2.1.3.1 Chute Automatic Sprinklers. Where material is to be stored at the bottom of the chute and above the riser discharge damper (above the transport tee), automatic sprinklers shall be installed below the last service door on the chute. [82:5.4.2.3]

21.16.2.1.3.2 Automatic sprinklers shall be installed in chute discharge rooms.
[82:5.4.2.4.3]

21.16.2.2 Waste Compactors. [82:7]

21.16.2.2.1 All chute-fed compactors shall have an automatic special fine-water spray sprinkler with a minimum ½ in. (13 mm) orifice installed in the hopper of the compactor.
[82:7.2.1]

21.16.2.2.1.1 Sprinklers shall be ordinary temperature-rated sprinklers. [82:7.2.1.1]

21.16.2.2.1.2 A cycling (on-off), self-actuating, snap-action, heat-actuated sprinkler shall be permitted to be used, or the sprinkler shall be permitted to be controlled by a temperature sensor operating a solenoid valve [82:7.2.1.4]

21.16.2.2.2 Hand-fed compactors located within a building and not operated in conjunction with a chute shall not require installation of an automatic sprinkler in the hopper. [82:7.2.2]

21.17 Standard for Ovens and Furnaces.

21.17.1 Design Requirements. (Reserved)

21.17.2 Installation Requirements.

21.17.2.1 Where automatic sprinklers are provided, they shall be installed in accordance with NFPA 13, unless otherwise permitted by 21.17.2.2.

21.17.2.2 Where sprinklers that protect ovens only are installed and connection to a reliable fire protection water supply is not feasible, a domestic water supply connection shall be permitted to supply these sprinklers subject to the approval of the authority having jurisdiction. [**86:** 14.2.2]

21.17.2.3 Where sprinklers are selected for the protection of ovens, furnaces, or related equipment, the use of closed-head sprinkler systems shall be prohibited and only deluge sprinkler systems shall be used where the following condition exist:

- (1) In equipment where temperatures can exceed 625°F (329°C)
- (2) Where flash fire conditions can occur[**86:** 13.3.3]

21.18 Industrial Furnaces Using a Special Process Atmosphere.

21.18.1 Design Requirements. (Reserved)

21.18.2 Installation Requirements. Where sprinkler systems are provided per NFPA 86, *Standard for Ovens and Furnaces*, sprinklers shall be of extra high-temperature rating [325°F to 650°F (163°C to 343°C)] to avoid premature operation from localized flashing. [**86A:**18.1.2(b)]

21.19 Class A Hyperbaric Chambers.

21.19.1 Design Requirements.

21.19.1.1 In chambers that consist of more than one chamber compartment (lock), the design of the deluge system shall meet the requirements of 20.2.5.2 of NFPA 99, *Standard for Health Care Facilities*, when the chamber compartments are at different depths (pressures). [**99:**20.2.5.2.1]

21.19.1.2 The deluge system in different compartments (locks) shall operate independently or simultaneously. [**99:**20.2.5.2.2]

21.19.1.3 Fixed deluge systems shall not be required in chamber compartments that are used strictly as personnel transfer compartments (locks), and for no other purposes. [**99:**20.2.5.2.3]

21.19.1.4* Manual activation and deactivation deluge controls shall be located at the operator's console and in each chamber compartment (lock) containing a deluge system. [**99:**20.2.5.2.4]

21.19.1.5 Controls shall be designed to prevent unintended activation. [**99:**20.2.5.2.4.1]

21.19.1.6 Water shall be delivered from the fixed discharge nozzles as specified in 21.19.1.8 within 3 seconds of activation of any affiliated deluge control. [**99:**20.2.5.2.5]

21.19.1.7* Average spray density at floor level shall be not less than 2 gpm/ft² (81.5 L/min/m²) with no floor area larger than 10.76 ft² (1 m²) receiving less than 1 gpm/ft² (40.75 L/min/m²). [99:20.2.5.2.6]

21.19.1.8 There shall be water available in the deluge system to maintain the flow specified in 21.19.1.7 simultaneously in each chamber compartment (lock) containing the deluge system for 1 minute. [99:20.2.5.2.7]

21.19.1.9 The limit on maximum extinguishment duration shall be governed by the chamber capacity (bilge capacity also, if so equipped) and/or its drainage system. [99:20.2.5.2.7.1]

21.19.1.10 The deluge system shall have stored pressure to operate for at least 15 seconds without electrical branch power. [99:20.2.5.2.8]

21.19.2 Installation Requirements. (Reserved)

21.20 Life Safety Code.

21.20.1 Features of Fire Protection.

21.20.1.1 Design Requirements. (Reserved)

21.20.1.2 Installation Requirements.

21.20.1.2.1 Atriums. Glass walls and inoperable windows shall be permitted in lieu of the fire barriers where all the following are met:

- (1) Automatic sprinklers are spaced along both sides of the glass wall and the inoperable window at intervals not to exceed 72 in. (1830 mm).
- (2) The automatic sprinklers specified in 21.20.1.2.1(1) are located at a distance from the glass wall not to exceed 12 in. (305 mm) and arranged so that the entire surface of the glass is wet upon operation of the sprinklers.
- (3) The glass wall is of tempered, wired, or laminated glass held in place by a gasket system that allows the glass framing system to deflect without breaking (loading) the glass before the sprinklers operate.
- (4) The automatic sprinklers required by 21.20.1.2.1(1) are not required on the atrium side of the glass wall and the inoperable window where there is no walkway or other floor area on the atrium side above the main floor level. [101:8.6.7(1)(c)]

21.20.2 Special Structures and High-Rise Buildings.

21.20.2.1 Design Criteria.

21.20.2.1.1 High-rise buildings shall be protected throughout by an approved, supervised automatic sprinkler system in accordance with NFPA 101, *Life Safety Code*, Section 9.7. A sprinkler control valve and a waterflow device shall be provided for each floor. [101:11.8.2.1]

21.20.3 New Assembly Occupancies. (Reserved)

21.20.4 Existing Assembly Occupancies. (Reserved)

21.20.5 New Educational Occupancies. (Reserved)

21.20.6 Existing Educational Occupancies. (Reserved)

21.20.7 New Day-Care Occupancies. (Reserved)

21.20.8 Existing Day-Care Occupancies. (Reserved)

21.20.9 New Health Care Occupancies. (Reserved)

21.20.10 Existing Health Care Occupancies. (Reserved)

21.20.11 New Ambulatory Health Care Occupancies. (Reserved)

21.20.12 Existing Ambulatory Health Care Occupancies. (Reserved)

21.20.13 New Detention and Correctional Occupancies. (Reserved)

21.20.14 Existing Detention and Correctional Occupancies. (Reserved)

21.20.15 One- and Two-Family Dwellings. (Reserved)

21.20.16 Lodging or Rooming Houses.

21.20.16.1 Design Requirements. (Reserved)

21.20.16.2 Installation Requirements.

21.20.16.2.1 In buildings sprinklered in accordance with NFPA 13, closets that contain equipment such as washers, dryers, furnaces, or water heaters shall be sprinklered regardless of size. [**101:26.3.6.3.5**]

21.20.16.2.2 In existing lodging or rooming houses, sprinkler installations shall not be required in closets not exceeding 24 ft² (2.2 m²) and in bathrooms not exceeding 55 ft² (5.1 m²). [**101:26.3.6.3.6**]

21.20.17 New Hotels and Dormitories.

21.20.17.1 Design Requirements. (Reserved)

21.20.17.2 Installation Requirements.

21.20.17.2.1 The provisions for draft stops and closely spaced sprinklers in NFPA 13 shall not be required for openings complying with NFPA *101, Life Safety Code*, 8.6.8.2, where the opening is within the guest room or guest suite. [**101:28.3.5.4**]

21.20.17.2.2 Listed quick-response or listed residential sprinklers shall be used throughout guest rooms and guest room suites. [**101:28.3.5.6**]

21.20.18 Existing Hotels and Dormitories.

21.20.18.1 Design Requirements. (Reserved)

21.20.18.2 Installation Requirements.

21.20.18.2.1 In guest rooms and in guest room suites, sprinkler installations shall not be

Copyright NFPA

required in closets not exceeding 24 ft² (2.2 m²) and in bathrooms not exceeding 55 ft² (5.1 m²). [101:29.3.5.5]

21.20.19 New Apartment Buildings.

21.20.19.1 Design Requirements. (Reserved)

21.20.19.2 Installation Requirements.

21.20.19.2.1 In buildings sprinklered in accordance with NFPA 13, closets less than 12 ft² (1.1 m²) in area in individual dwelling units shall not be required to be sprinklered. Closets that contain equipment such as washers, dryers, furnaces, or water heaters shall be sprinklered regardless of size. [101:30.3.5.4]

21.20.19.2.2 Listed quick-response or listed residential sprinklers shall be used throughout all dwelling units. [101:30.3.5.6]

21.20.19.2.3 The draft stop and closely spaced sprinkler requirements of NFPA 13 shall not be required for convenience openings complying with NFPA 101, 8.6.8.2, where the convenience opening is within the dwelling unit. [101:30.3.5.5]

21.20.20 Existing Apartment Buildings.

21.20.20.1 Design Requirements. (Reserved)

21.20.20.2 Installation Requirements.

21.20.20.2.1 In individual dwelling units, sprinkler installation shall not be required in closets not exceeding 24 ft² (2.2 m²) and in bathrooms not exceeding 55 ft² (5.1 m²). Closets that contain equipment such as washers, dryers, furnaces, or water heaters shall be sprinklered regardless of size. [101:31.3.5.4]

21.20.20.2.2 The draft stop and closely spaced sprinkler requirements of NFPA 13 shall not be required for convenience openings complying with NFPA 101, 8.6.8.2, where the convenience opening is within the dwelling unit. [101:31.3.5.5]

21.20.21 New Residential Board and Care Occupancies. (Reserved)

21.20.22 Existing Residential Board and Care Occupancies.

21.20.22.1 Design Requirements. (Reserved)

21.20.22.2 Installation Requirements.

21.20.22.2.1 Standard response sprinklers shall be permitted for use in hazardous areas in accordance with NFPA 101, 33.2.3.2. [101:33.2.2.2.4]

21.20.22.2.2 In prompt and slow evacuation facilities, where an automatic sprinkler system is in accordance with NFPA 13 sprinklers shall not be required in closets not exceeding 24 ft² (2.2 m²) and in bathrooms not exceeding 55 ft² (5.1 m²), provided that such spaces are finished with lath and plaster or materials providing a 15-minute thermal barrier. [101:33.2.3.5.2.3]

21.20.23 New Mercantile Occupancies.

21.20.23.1 Design Requirements. (Reserved)

21.20.23.2 Installation Requirements.

21.20.23.2.1 Protection of Vertical Openings. Any vertical opening shall be protected in accordance with NFPA *101*, Section 8.6, except under the following conditions:

- (1) In Class A or Class B mercantile occupancies protected throughout by an approved, supervised automatic sprinkler system in accordance with NFPA *101*, 9.7.1.1(1), unprotected vertical openings shall be permitted at one of the following locations:
 - (a) Between any two floors
 - (b) Among the street floor, the first adjacent floor below, and adjacent floor (or mezzanine) above
- (2) In Class C mercantile occupancies, unprotected openings shall be permitted between the street floor and the mezzanine.
- (3) The draft stop and closely spaced sprinkler requirements of NFPA 13 shall not be required for unenclosed vertical openings permitted in NFPA *101*, 36.3.1(1) and (2). [101:36.3.1]

21.20.23.2.2 Rooms housing building service equipment, janitor closets, and service elevators shall be permitted to open directly onto exit passageways, provided that the following criteria are met:

- (1) The required fire resistance rating between such rooms or areas and the exit passageway shall be maintained in accordance with NFPA *101*, 7.1.3.2.
- (2) Such rooms or areas shall be protected by an approved, supervised automatic sprinkler system in accordance with NFPA *101*, 9.7.1.1(1) but the exceptions in NFPA 13 allowing the omission of sprinklers from such rooms shall not be permitted. [101:36.4.4.6.2]

21.20.24 Existing Mercantile Occupancies.

21.20.24.1 Design Requirements. (Reserved)

21.20.24.2 Installation Requirements.

21.20.24.2.1 Protection of Vertical Openings. Any vertical opening shall be protected in accordance with NFPA *101*, Section 8.6, except under the following conditions:

- (1) In Class A or Class B mercantile occupancies protected throughout by an approved, supervised automatic sprinkler system in accordance with NFPA *101*, 9.7.1.1(1), unprotected vertical openings shall be permitted at one of the following locations:
 - (a) Between any two floors
 - (b) Among the street floor, the first adjacent floor below, and adjacent floor (or mezzanine) above
- (2) In Class C mercantile occupancies, unprotected openings shall be permitted between

the street floor and the mezzanine.

- (3) The draft stop and closely spaced sprinkler requirements of NFPA 13 shall not be required for unenclosed vertical openings permitted in NFPA 101, 37.3.1(1) and (2).
[101:37.3.1]

21.20.24.2.2 Rooms housing building service equipment, janitor closets, and service elevators shall be permitted to open directly onto exit passageways, provided that the following criteria are met:

- (1) The required fire resistance rating between such rooms or areas and the exit passageway shall be maintained in accordance with NFPA 101, 7.1.3.2.
- (2) Such rooms or areas shall be protected by an approved, supervised automatic sprinkler system in accordance with NFPA 101, 9.7.1.1(1) but the exceptions in NFPA 13 allowing the omission of sprinklers from such rooms shall not be permitted.
[101:37.4.4.6.2]

21.20.25 New Business Occupancies.

21.20.25.1 Design Requirements. (Reserved)

21.20.25.2 Installation Requirements. (Reserved)

21.20.26 Existing Business Occupancies.

21.20.26.1 Design Requirements. (Reserved)

21.20.26.2 Installation Requirements. (Reserved)

21.20.27 Industrial Occupancies. (Reserved)

21.20.27.1 Design Criteria.

21.20.27.1.1 Special Provisions — High-Rise Buildings. The automatic sprinkler requirements of NFPA 101, 11.8.2.1, shall be required for new high-rise industrial occupancies, except for general low hazard or special-purpose industrial occupancies.
[101:40.4]

21.20.28 Storage Occupancies. (Reserved)

21.21 Fixed Guideway Transit Systems.

21.21.1 Design Requirements. (Reserved)

21.21.2 Installation Requirements. (Reserved)

21.22 Motion Picture and Television Production Studio Soundstages and Approved Production Facilities.

21.22.1 Design Requirements.

21.22.1.1 The requirements of NFPA 13 prohibiting obstruction to sprinkler discharge shall not be applicable if approved mitigation techniques are employed. [140:5.2.3.1]

21.22.1.2 The requirements of NFPA 13 prohibiting obstruction to sprinkler discharge shall not be applicable if the building sprinkler system meets the design criteria for extra hazard Group 2. [140:5.2.3.2]

21.22.2 Installation Requirements. (Reserved)

21.23 Animal Housing Facilities.

21.23.1 Design Requirements.

21.23.1.1 (Reserved)

21.23.2 Installation Requirements. (Reserved)

21.23.2.1 Quick-response sprinklers shall be utilized throughout the animal housing facility. [150:9.2.3]

21.24 Water Cooling Towers.

21.24.1 Design Requirements.

21.24.1.1 Types of Systems.

21.24.1.1.1* Because the counterflow tower design lends itself to either closed- or open-head systems, the following systems shall be permitted to be used:

- (1) Wet-pipe
- (2) Dry-pipe
- (3) Preaction
- (4) Deluge [214:5.2.2.1]

21.24.1.1.2* The open-head deluge system shall be used in crossflow towers to maximize the water distribution and heat detection activation. [214:5.2.2.2]

21.24.1.2 Minimum Rate of Application. [241:5.2.3]

21.24.1.2.1 Under the fan decks of counterflow towers, the rate of application of water shall be 0.5 gpm/ft² (20.4 mm/min), including fan opening. [214:5.2.3.1]

21.24.1.2.2 Under the fan decks of crossflow towers, the rate of application of water shall be 0.33 gpm/ft² (13.45 mm/min), including fan opening. [214:5.2.3.2]

21.24.1.2.3 Over the fill areas of crossflow towers, the rate of application of water shall be 0.5 gpm/ft² (20.4 mm/min). [214:5.2.3.3]

21.24.1.3 Extended Fan Decks. On towers having extended fan decks that completely enclose the distribution basin, the discharge outlets protecting the fill area shall be located over the basin, under the extension of the fan deck. [214:5.2.4.3]

21.24.1.3.1 These discharge outlets shall be open directional spray nozzles or other approved spray devices arranged to discharge 0.35 gpm/ft² (14.26 mm/min) directly on the distribution basin and 0.15 gpm/ft² (6.11 mm/min) on the underside of the fan deck

extension. [214:5.2.4.3.1]

21.24.1.3.2 On towers having extended fan decks that do not completely enclose the hot-water basin, outlets protecting the fill shall be located under the distribution basin in accordance with 5.2.4.2.2 of NFPA 214, *Standard on Water-Cooling Towers*.

[214:5.2.4.3.2]

21.24.1.4 Combustible Fan Decks. For deluge systems using directional spray nozzles in the pendent position, provisions shall be made to protect the underside of a combustible fan deck at a minimum of 0.15 gpm/ft² (6.11 mm/min), which shall be included as part of the application rate specified in 5.2.3 of NFPA 214, *Standard on Water-Cooling Towers*.

[214:5.2.4.4]

21.24.1.5 Water Basin Covers. On film-filled towers that have solid, hot-water basin covers over the complete basin, the discharge outlets protecting the fill area shall be permitted to be located under the basin covers.

21.24.1.5.1 These discharge outlets shall be open directional spray nozzles or other approved devices arranged to discharge 0.50 gpm/ft² (20.4 mm/min) into the distribution basin horizontally, with some of the spray splashing up and on the underside of the water basin covers. [214:5.2.4.5.1]

21.24.1.6 Exterior Protection. Systems for exterior protection shall be designed with the same attention and care as interior systems. [214:5.2.10.2]

21.24.1.6.1 Pipe sizing shall be based on hydraulic calculations. [214:5.2.10.2.1]

21.24.1.6.2 Water supply and discharge rate shall be based on a minimum 0.15 gpm/ft² (6.11 mm/min) for all protected surfaces. [214:5.2.10.2.2]

21.24.1.7 Sprinkler System Water Supply.

21.24.1.7.1 Deluge Systems.

21.24.1.7.1.1* Where all cells of a cooling tower are protected by a single deluge system, the water supply shall be adequate to supply all discharge outlets on that system.

[214:5.6.1.1]

21.24.1.7.1.2 Where two or more deluge systems are used to protect a cooling tower and fire-resistant partitions are not provided between the deluge systems, the water supply shall be adequate to supply all discharge outlets in the two most hydraulically demanding adjacent systems. [214:5.6.1.2]

21.24.1.7.1.3* Where two or more deluge systems are separated by fire-resistant partitions, the water supply shall be adequate to supply all discharge outlets in the single most hydraulically demanding system. [214:5.6.1.3]

21.24.1.7.2 Wet, Dry, and Preaction Systems.

21.24.1.7.2.1* Where each cell of the cooling tower is separated by a fire-resistant partition, the water supply shall be adequate to supply all discharge outlets in the hydraulically most demanding single cell. [214:5.6.2.1]

21.24.1.7.2.2* Where fire-resistant partitions are not provided between each cell of a cooling tower, the water supply shall be adequate to supply all discharge outlets in the two most hydraulically demanding adjoining cells. [214:5.6.2.2]

21.24.1.7.3 Hose Streams. Water supplies shall be sufficient to include a minimum of 500 gpm (1892.5 L/min) for hose streams in addition to the sprinkler requirements. [214:5.6.3]

21.24.1.7.4 Duration. An adequate water supply of at least a 2-hour duration shall be provided for the combination of the water supply specified in 5.6.1 or 5.6.2 of NFPA 214, *Standard on Water-Cooling Towers*, plus the hose stream demand specified in 21.24.1.7.3. [214:5.6.4]

21.24.2 Installation Requirements.

21.24.2.1* Counterflow Towers. [214:5.2.4.1]

21.24.2.1.1 The discharge outlets shall be located under the fan deck and fan opening. [214:5.2.4.1.1]

21.24.2.1.2 Except under the fan opening, all discharge outlets shall have deflector distances installed in accordance with Section 8.5. [214:5.2.4.1.2]

21.24.2.1.3 Closed-head discharge outlets for dry pipe and preaction systems shall be installed in the upright position only. [214:5.2.4.1.3]

21.24.2.2* Crossflow Towers. [214:5.2.4.2]

21.24.2.2.1 The discharge outlets protecting the plenum area shall be located under the fan deck and in the fan opening. [214:5.2.4.2.1]

21.24.2.2.2 Discharge outlets protecting the fill shall be located under the distribution basin on either the louver or drift eliminator side, discharging horizontally through the joist channels. [214:5.2.4.2.2]

21.24.2.2.3 Towers with an air travel dimension longer than the maximum allowable for the discharge device being used shall have discharge devices placed on both sides of the fill area in each joist channel. [214:5.2.4.2.3.1]

21.24.2.2.4 The pressure at each discharge device shall be adequate to provide protection for half of the length of the fill measured along the air travel. [214:5.2.4.2.3.2]

21.24.2.2.5 Where joist channels are wider than 2 ft (0.6 m), more than one discharge device shall be required per joist channel. [214:5.2.4.2.4.1]

21.24.2.2.6 If the discharge device being used is listed for the width of the joist channel being protected, one discharge device per joist channel shall be permitted to be used. [214:5.2.4.2.4.2]

21.24.2.3* Extended Fan Decks. On towers having extended fan decks that completely enclose the distribution basin, the discharge outlets protecting the fill area shall be located over the basin, under the extension of the fan deck. [214:5.2.4.3]

21.24.2.4 Combustible Fan Decks. For deluge systems using directional spray nozzles in

the pendent position, provisions shall be made to protect the underside of a combustibile fan deck at a minimum rate of 0.15 gpm/ft² (6.11 mm/min), which shall be included as part of the application rate specified in 21.24.1.2. [214:5.2.4.4]

21.24.2.5* Water Basin Covers. On film-filled towers that have solid, hot-water basin covers over the complete basin, the discharge outlets protecting the fill area shall be permitted to be located under the basin covers. [214:5.2.4.5]

21.24.2.6 Valves. [214:5.2.6]

21.24.2.6.1 Shutoff valves and automatically operated water control valves, if provided, shall be located as follows:

- (1) Outside the fire-exposed area
- (2) As close to the cooling tower as possible to minimize the amount of pipe to the discharge device
- (3) Where they will be accessible during a fire emergency [214:5.2.6.1.2]

21.24.2.6.2 Manual Release Valve. [214:5.2.6.2]

21.24.2.6.2.1 Remote manual release valves, where required, shall be conspicuously located and accessible during a fire emergency. [214:5.2.6.2.1]

21.24.2.6.2.2 Where remote manual release valves are not required, an inspector's test valve shall be provided for each pilot-head-operated system. [214:5.2.6.2.2]

21.24.2.7 Strainers. Strainers shall be required for systems utilizing discharge devices with waterways of less than 0.375 in. (9.5 mm) diameter. [214:5.2.7]

21.24.2.8 Heat Detectors. Where deluge or preaction systems are used, heat detectors shall be installed and shall be selected from either of the types in 5.2.8.1 or 5.2.8.2 of NFPA 214, *Standard on Water-Cooling Towers*. [214:5.2.8]

21.24.2.8.1 In mechanical-draft towers, pilot line detectors shall be located under the fan deck at the circumference of the fan opening and under the fan opening where necessary to comply with the spacing requirements in 21.24.2.8.1.1. (*For extended fan decks, see 5.2.8.2.3 in NFPA 214, Standard on Water-Cooling Towers.*) [214:5.2.8.1.2.1(A)]

21.24.2.8.1.1 Pilot line detectors shall be spaced not more than 8 ft (2.4 m) apart in any direction including the fan opening. Temperature ratings shall be selected in accordance with operating conditions, but shall be no less than intermediate. [214:5.2.8.1.2.1(B)]

21.24.2.8.2 On towers having extended fan decks that completely enclose the distribution basin, electrical heat detectors shall be located under the fan deck extension in accordance with standard, indoor-spacing rules for the type detectors used in accordance with *NFPA 72, National Fire Alarm Code*. [214:5.2.8.2.3]

21.24.2.8.2.1 Where the fan deck extension is 16 ft (4.9 m) or less and this dimension is the length of the joist channel, then only one row of detectors centered on and at right angles to the joist channels shall be required. Spacing between detectors shall be in accordance with *NFPA 72, National Fire Alarm Code*. [214:5.2.8.2.3.1]

21.24.2.8.2.2 On towers having extended fan decks that do not completely enclose the hot-water basin, electrical heat detectors shall not be required under the fan deck extension. [214:5.2.8.2.3.2]

21.24.2.8.3 Where electrical heat detectors are inaccessible during tower operation, an accessible test detector shall be provided for each detection zone. [214:5.2.8.3]

21.24.2.8.4 Electrical heat detector components exposed to corrosive vapors or liquids shall be protected by materials of construction or by protective coatings applied by the equipment manufacturer. [214:5.2.8.4]

21.24.2.9 Protection for Fan Drive Motor. [214:5.2.9]

21.24.2.9.1 A water discharge outlet activated by a pilot line detector or a listed electrical heat detector shall be provided over each fan drive motor when the motor is located so that it is not within the protected area of the tower. [214:5.2.9.1]

21.24.2.9.2 Provision shall be made to interlock the fan motors with the fire protection system so that the cooling tower fan motors are stopped in the cell(s) for which the system is actuated. [214:5.2.9.2]

21.24.2.9.3 Where the continued operation of the fans is vital to the process, a manual override switch shall be permitted to be provided to reactivate the fan when it is determined that there is no fire. [214:5.2.9.3]

21.24.2.10 Corrosion Protection. [214:5.3]

21.24.2.10.1 Piping, fittings, hangers, braces, and attachment hardware including fasteners shall be hot-dip galvanized steel per ASTM A 153A/ 153M, *Standard Specification for Zinc Coating (Hot Dip) on Iron and Steel Hardware*, or other materials having a superior corrosion resistance. [214:5.3.1]

21.24.2.10.1.1 Exposed pipe threads and bolts on fittings shall be protected against corrosion. [214:5.3.1.1]

21.24.2.10.1.2 All other components shall be corrosion resistant or protected against corrosion by a coating. [214:5.3.1.2]

21.24.2.10.2* Wax-type coatings shall not be used on devices without fusible elements. [214:5.3.2]

21.24.2.10.3* Special care shall be taken in the handling and installation of wax-coated or similar sprinklers to avoid damaging the coating. [214:5.3.3]

21.24.2.10.3.1 Corrosion-resistant coatings shall not be applied to the sprinklers by anyone other than the manufacturer of the sprinklers. [214:5.3.3.1]

21.24.2.10.3.2 In all cases, any damage to the protective coating occurring at the time of installation shall be repaired at once using only the coating of the manufacturer of the sprinkler in an approved manner, so that no part of the sprinkler will be exposed after the installation has been completed. [214:5.3.3.2]

21.25 Standard for the Construction and Fire Protection of Marine Terminals, Piers, and Wharves.

21.25.1 Design Requirements.

21.25.1.1* For terminal buildings that do not meet the requirements of 21.25.1.2, automatic sprinkler systems shall be designed based upon the design criteria for the protection of Group A plastics. [307:5.4.2.1]

21.25.1.2 With the approval of the authority having jurisdiction, the requirements of 21.25.1.1 shall not apply to buildings used exclusively for the handling or storage of specific cargoes and commodities that are defined as commodity classes less than Group A plastics by this standard. [307:5.4.2.2]

21.25.1.3 Buildings consistent with 21.25.1.2 shall be protected in accordance with the design criteria for the applicable commodity as required by this standard. [307:5.4.2.3]

21.25.1.4 Buildings used for the storage of hazardous materials shall be protected in accordance with this standard and the applicable codes and standards for the type of hazardous material being stored. [307:5.4.2.4]

21.25.2 Installation Requirements.

21.25.2.1 Piers and Wharves with Combustible Substructure.

21.25.2.1.1 Where there is danger of damage to sprinkler equipment by floating objects, physical barriers shall be provided to exclude such objects. [307:4.3.3.1.2.2]

21.25.2.1.2 The installation requirements in 21.25.2.1.2.1, 21.25.2.1.2.1(A), and 21.25.2.1.2.1(B) are also required.

21.25.2.1.2.1* Upward Projecting Sprinklers. Where narrow horizontal channels or spaces are caused by caps, stringers, ties, and other structural members and where the standard upright sprinkler does not project sufficient water upward to extinguish or control fires on the underside of the pier or wharf deck, a sprinkler that projects water upward to wet the overhead shall be used.

(A) Location, spacing, and deflector position shall be governed by the discharge pattern of the sprinkler and the structure being protected.

(B) The following design and installation guides shall apply where pendent sprinklers in the upright position or old-style sprinklers are to be utilized:

- (1) The maximum coverage per sprinkler head shall be limited to 80 ft² (7.5 m²).
- (2) Where spacing or arrangement of stringers constitutes typical open-joint construction directly supporting the deck, sprinkler branch lines shall be installed between the bents at right angles to the stringers and shall meet the following requirements:
 - (a) Spacing between branch lines shall not exceed 10 ft (3 m).

- (b) Sprinklers on branch lines shall be staggered and spaced not to exceed 8 ft (2.5 m) on center.
- (3)* Where crisscross construction is involved, closer spacing of sprinklers shall be permitted as necessary to provide wetting of the entire structure.
- (4) The deflectors of sprinklers on lines under stringers shall be located not less than 4 in. (100 mm) nor more than 10 in. (250 mm) below the bottom plane of the stringer, and not more than 18 in. (450 mm) below the underside of the pier or wharf deck.
- (5)* The sprinkler system shall be hydraulically designed in accordance with the requirements of this standard and shall meet the following requirements:
 - (a) Sprinkler orifice shall be ½ in. (12.7 mm) and shall discharge at a minimum pressure of 12.5 psi (85 kPa).
 - (b) Design area shall be based upon the largest area between firestops plus an additional area embracing at least two branch lines on opposite sides of the firestop.
 - (c) Minimum design area shall be not less than 5000 ft² (465 m²).
- (6) The temperature rating of the sprinkler shall not exceed 165°F (74°C).
- (7) The maximum area to be protected by any one system shall be limited to 25,000 ft² (2325 m²).

• [307:4.3.3.1.3.1]

21.26 Cleanrooms.

21.26.1 Design Requirements.

21.26.1.1* Automatic sprinklers for cleanrooms or clean zones shall be hydraulically designed for a density of 0.20 gpm/ft² (8.15 L/min · m²) over a design area of 3000 ft² (278.8 m²). [318:4.1.2.1]

21.26.1.2 Automatic sprinkler protection shall be designed and installed in the plenum and interstitial space above cleanrooms for a density of 0.20 gpm/ft² (8.15 L/min · m²) over a design area of 3000 ft² (278.8 m²). [318:4.1.2.5]

21.26.1.2.1 Automatic sprinklers shall be permitted to be omitted if the construction and occupancy of these spaces are noncombustible. [318:4.1.2.5.1]

21.26.1.3* Sprinklers installed in duct systems shall be hydraulically designed to provide 0.5 gpm (1.9 L/min) over an area derived by multiplying the distance between the sprinklers in a horizontal duct by the width of the duct. [318:4.1.2.6.2]

21.26.1.3.1 Minimum discharge shall be 20 gpm (76 L/min) per sprinkler from the five hydraulically most remote sprinklers. [318:4.1.2.6.2.1]

21.26.2 Installation Requirements.

21.26.2.1 Wet pipe automatic sprinkler protection shall be provided throughout facilities

containing cleanrooms and clean zones. [318:4.1.1]

21.26.2.2* Approved quick-response sprinklers shall be utilized for sprinkler installations within down-flow airstreams in cleanrooms and clean zones. [318:4.1.2.2]

21.26.2.3* Sprinklers installed in ductwork shall be spaced a maximum of 20 ft (6.1 m) apart horizontally and 12 ft (3.7 m) apart vertically. [318:4.1.2.6.2.2]

21.26.2.4 A separate indicating control valve shall be provided for sprinklers installed in ductwork. [318:4.1.2.6.3]

21.26.2.5 The sprinklers shall be accessible for periodic inspection and maintenance. [318:4.1.2.6.6]

21.27 Aircraft Hangars.

21.27.1 Design Requirements. Sprinkler systems installed in aircraft hangars shall comply with NFPA 409, *Standard on Aircraft Hangars*.

21.27.2 Installation Requirements. Sprinkler systems installed in aircraft hangars shall comply with NFPA 409, *Standard on Aircraft Hangars*.

21.28 Standard on Airport Terminal Buildings, Fueling Ramp Drainage, and Loading Walkways.

21.28.1 Design Requirements.

21.28.1.1 Passenger handling areas shall be classified as ordinary hazard Group 1 occupancy for the purpose of sprinkler system design. [415:4.5.1.3]

21.28.1.2* Baggage, package, and mail handling areas shall be classified as ordinary hazard Group 2 occupancy for the purpose of sprinkler system design. [415:4.5.1.4]

21.28.1.3 Other areas of the airport terminal building shall be classified based on the occupancy of the area. [415:4.5.1.5]

21.28.2 Installation Requirements. (Reserved)

21.29 Aircraft Engine Test Facilities.

21.29.1 Design Requirements.

21.29.1.1* In engine test cells, the minimum design discharge density shall be 0.5 gpm/ft² (0.34 L/sec/m²) of protected area. [423:7.6.3]

21.29.1.2 In engine test cells, water supplies shall be capable of meeting the largest demand at the design rate plus hose stream demand for a period of 30 minutes. [423:7.6.4]

21.29.1.2.1 Hose stream demand shall be a minimum of 250 gpm (16 L/sec). [423:7.6.4.1]

21.29.1.2.2 The hydraulic calculation and the water supply shall be based on the assumption that all sprinklers in the test cell are operating simultaneously. [423:7.6.4.2]

21.29.2 Installation Requirements. (Reserved)

21.30 Code for the Storage of Liquid and Solid Oxidizers.

21.30.1 Design Requirements.

21.30.1.1* Sprinkler Protection for Class 1 Oxidizers. For the purpose of applying the requirements of NFPA 13, Class 1 oxidizers shall be designated as follows:

- (1) Class 1 oxidizers in noncombustible or combustible containers (paper bags or noncombustible containers with removable combustible liners) shall be designated as a Class I commodity.
- (2) Class 1 oxidizers contained in fiber drums, wooden or fiber boxes or barrels, or noncombustible containers in combustible packaging shall be designated as a Class II commodity
- (3) Class 1 oxidizers contained in plastic containers shall be designated as a Class III commodity. [430:5.3.2]

21.30.1.2 Sprinkler Protection for Class 2 Oxidizers.

21.30.1.2.1 Sprinkler protection for Class 2 oxidizers shall be designed in accordance with Table 21.30.1.2.1. [430:6.4.1]

Table 21.30.1.2.1 Ceiling Sprinkler Protection for Class 2 Oxidizers in Palletized or I						
Type of Storage	Ceiling Sprinklers				Area of Applica	
	Storage Height		Density			
	ft	m	gpm/ft ²	L/min/m ²	ft ²	
Palletized or bulk	8	2.4	0.20	8	3750	
Palletized or bulk	12	3.7	0.35	14	3750	
Rack	12	3.7	0.20	8	3750	
Rack	16	4.9	0.30	12	2000	

[430: Table 6.4.1]

21.30.1.2.2 Ceiling sprinklers shall be high-temperature sprinklers. [430:6.4.3]

21.30.1.2.3 Storage Protection with In-Rack Sprinklers.

21.30.1.2.3.1 In-rack sprinklers shall be quick response with an ordinary temperature rating and have a K-factor of not less than K = 8.0. [430:6.4.4.1]

21.30.1.2.3.2 In-rack sprinklers shall be designed to provide 25 psi (172 kPa) for the six most hydraulically remote sprinklers on each level. [430:6.4.4.2]

21.30.1.2.3.3 The in-rack sprinklers shall be 8 ft to 10 ft (2.4 m to 3.0 m) spacings in the longitudinal flue space at the intersection of the transverse flue spaces. [430:6.4.4.3]

21.30.1.3 Sprinkler Protection for Class 3 Oxidizers.

21.30.1.3.1 Class 3 Oxidizers Less Than 2300 lb (1043 kg). Sprinkler design criteria for buildings that require sprinkler protection having total quantities of Class 3 oxidizers less than the 2300 lb (1043 kg) shall be in accordance with the requirements of 21.30.1.3.2. [430:7.4.1]

21.30.1.3.2 Facilities that require sprinkler protection having total quantities of Class 3 oxidizers greater than 200 lb (91 kg) but less than 2300 lb (1043 kg) shall follow the sprinkler design criteria in accordance with Table 21.30.1.3.2. [430: 7.4.1.1]

Table 21.30.1.3.2 Sprinkler Protection of Class 3 Oxidizers Stored in Total Quantities Greater Than 200 lb (91 kg) but Less Than 2300 lb (1043 kg)

	Shelf	Bulk or Pile	B
Maximum storage height	6 ft (1.8 m)	5 ft (1.5 m)	1
Maximum ceiling height	25 ft (7.6 m)	25 ft (7.6 m)	2
Aisles — pile separation	4 ft (1.2 m) min clear aisles	4 ft (1.2 m) min clear aisles	8 ft (2.4 m)
Ceiling design criteria	0.45 gpm/2000 ft ²	0.35 gpm/5000 ft ² or 0.6 gpm/2000 ft ²	0.65
In-rack sprinklers	NP	NP	
Hose stream demand	500 gpm	500 gpm	
Duration	120 minutes	120 minutes	1

NP: Not permitted.
[430: Table 7.4.1.1]

21.30.1.3.3 Sprinkler protection required by 21.30.1.3.3 shall be in accordance with the requirements of Table 21.30.1.3.3. [430:7.4.2.1]

Table 21.30.1.3.3 Sprinkler Protection of Class 3 Oxidizers Stored in Total Quantities Greater Than or Equal to 2300 lb (1043 kg)

	Bulk or Pile	Rack
Maximum storage height	10 ft (3 m)	10 ft (3 m)
Maximum ceiling height	25 ft (7.6 m)	NP
Aisles — pile separation	8 ft (2.4 m) min clear aisles	8 ft (2.4 m) min clear aisles
Ceiling design criteria	0.65 gpm/5000 ft ²	Predominant for other commodities but not less than ordinary hazard Group II
In-rack sprinklers	NP	See 7.4.2.2 of NFPA 430
Hose stream demand	500 gpm	500 gpm
Duration	120 minutes	120 minutes

NP: Not permitted.
[430: Table 7.4.2.1]

21.30.1.4 Sprinkler Protection for Class 4 Oxidizers. Sprinkler protection for Class 4

oxidizers shall be installed on a deluge sprinkler system to provide water density of 0.35 gpm/ft² (14.4 L/min/m²) over the entire storage area. [430:8.4.1]

21.30.2 Installation Requirements.

21.30.2.1* Dry Pipe and Preaction Sprinkler Systems.

21.30.2.1.1 Dry pipe and double-interlock preaction (DIPA) sprinkler systems shall not be permitted for protection of buildings or areas containing oxidizers. [430:4.11.3.1]

21.30.2.1.2 Dry pipe and DIPA systems shall be permitted for protection of Class 1 oxidizers in Type I through Type IV building construction and Class 2 and 3 oxidizers in detached storage in Type I and Type II construction as specified in *NFPA 5000, Building Construction and Safety Code*. [430:4.11.3.2]

21.30.2.1.3 Dry pipe and DIPA sprinkler systems shall be permitted in mercantile occupancies when the oxidizers are stored in open air environments, such as retail garden centers and buildings without exterior walls. For Class 3 oxidizers, the location shall be approved by the fire chief. [430:4.11.3.3]

21.30.2.2 Fire Protection Water Supplies.

21.30.2.2.1 The water supply shall be capable of providing not less than 750 gpm (2840 L/min) where protection is by means of hose streams, or 500 gpm (1890 L/min) for hose streams in excess of the automatic sprinkler water demand. [430:4.11.4.2]

21.30.2.2.2 Duration of the water supply shall be a minimum of 2 hours. [430:4.11.4.3]

21.30.2.3 Special In-Rack Sprinkler Protection for Class 3 Oxidizers. In-rack automatic sprinklers shall be provided under each horizontal barrier and arranged in accordance with 21.30.2.3.2 through 21.30.2.3.9. [430:7.4.2.2.3]

21.30.2.3.1 Where required by Table 21.30.1.3.3, special in-rack sprinkler protection shall be as shown in Figure 21.30.2.3.1. [430:7.4.2.2.1]

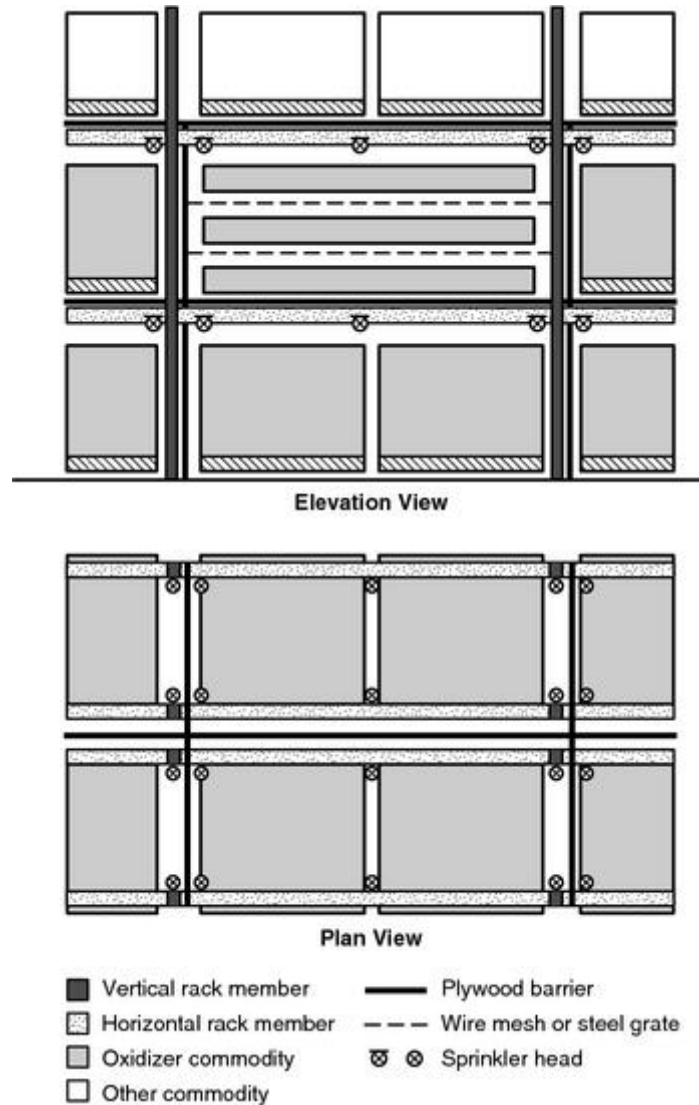

FIGURE 21.30.2.3.1 Arrangement of Barriers and In-Rack Sprinklers for Special Fire Protection Provisions. [430: Figure 7.4.2.2.1]

21.30.2.3.2 For double-row racks, two lines of in-rack sprinklers shall be provided between the face of the rack and the longitudinal vertical barrier located in the center of the rack. [430:7.4.2.2.3.1]

21.30.2.3.3 For single-row racks, two lines of in-rack sprinklers shall be provided between each rack face. [430:7.4.2.2.3.2]

21.30.2.3.4 Three in-rack sprinklers shall be provided on each in-rack sprinkler line. [430:7.4.2.2.3.3]

21.30.2.3.4.1 Two sprinklers on each line shall be spaced approximately 1½ in. (38.1 mm) from each transverse vertical barrier. [430:7.4.2.2.3.3(A)]

21.30.2.3.4.2 One in-rack sprinkler on each in-rack sprinkler line shall be located approximately equidistant between the transverse vertical barriers. [430:7.4.2.2.3.3(B)]

21.30.2.3.5 In-rack sprinklers shall be upright or pendent type with the fusible element located no more than 6 in. (152.4 mm) from the horizontal barrier. [430:7.4.2.2.3.4]

21.30.2.3.6 The stock shall be maintained at least 6 in. (152.4 mm) below the sprinkler deflector. [430:7.4.2.2.3.5]

21.30.2.3.7 In-rack sprinklers shall be $K = 8.0$, quick response, ordinary temperature rated. [430:7.4.2.2.3.6]

21.30.2.3.8 The in-rack sprinkler system shall be designed to supply six sprinklers on each line with a total of 12 sprinklers operating at gauge pressure of 25 psi (172 kPa). [430:7.4.2.2.3.7]

21.30.2.3.9 The design of the in-rack sprinkler system shall be independent of, and is not required to be balanced with, ceiling sprinkler systems. [430:7.4.2.2.3.8]

21.31 Storage of Organic Peroxide Formulations.

21.31.1 Design Requirements.

21.31.1.1 Where automatic sprinkler systems are required per NFPA 432, *Code for the Storage of Organic Peroxide Formulations*, they shall provide the following discharge densities:

- (1) Class I — 0.5 gpm/ft² (20.4 L/min · m²)
 - (2) Class II — 0.4 gpm/ft² (16.3 L/min · m²)
 - (3) Class III — 0.3 gpm/ft² (12.2 L/min · m²)
 - (4) Class IV — 0.25 gpm/ft² (10.2 L/min · m²)
- [432:4.8.2]

21.31.1.2 The system shall be designed to provide the required density over a 3000 ft² (280 m²) area for areas protected by a wet pipe sprinkler system or 3900 ft² (360 m²) for areas protected by a dry pipe sprinkler system. The entire area of any building of less than 3000 ft² (280 m²) shall be used as the area of application. [432:4.8.2.1]

21.31.1.3 Sprinkler System Water Supply. Where required, supplies for automatic sprinklers, water fire hydrants, and so forth, shall be capable of supplying the anticipated demand for at least 90 minutes. [432:4.8.3]

21.31.1.4 Detached Storage of Class I Organic Peroxide Formulations. Sprinkler protection for Class I organic peroxide formulations in quantities exceeding 2000 lb (907 kg) in detached storage shall be of the deluge type. [432:7.5.2]

21.31.2 Installation Requirements. (Reserved)

21.32 Advanced Light Water Reactor Electric Generating Plants.

21.32.1 Design Requirements.

21.32.1.1* Sprinkler System Water Supply. The fire water supply shall be calculated on

the basis of the largest expected flow rate for a period of 2 hours, but shall not be less than 300,000 gal (1,135,500 L), and the following criteria also shall apply:

- (1) The flow rate shall be based on 500 gpm (1892.5 L/min) for manual hose streams plus the largest design demand of any sprinkler or fixed water spray system.
- (2) The fire water supply shall be capable of delivering the design demand specified in 21.32.1.1(1) with the hydraulically least demanding portion of fire main loop out of service. [804:9.2.1]

21.32.1.2 Yard Mains. The underground yard fire main loop shall be installed to furnish anticipated water requirements, and the following criteria also shall be met:

- (1) The type of pipe and water treatment shall be design considerations, with tuberculation as one of the parameters.
- (2) Means for inspecting and flushing the systems shall be provided. [804:9.4.1]

21.32.1.3 Cable Tunnels. [804:10.4.2]

21.32.1.3.1 Automatic sprinkler systems shall be designed for a density of 0.3 gpm/ft² (12.2 L/min · m²) for the most remote 100 linear ft (30.5 m) of cable tunnel up to the most remote 2500 ft² (232.2 m²). [804:10.4.2.2.2]

21.32.1.3.2 Deluge sprinkler systems or deluge spray systems shall meet the following criteria:

- (1) They shall be zoned to limit the area of protection to that which the drainage system can handle with any two adjacent systems actuated.
- (2) They shall be hydraulically designed with each zone calculated with the largest adjacent zone flowing. [804:10.4.2.2.4]

21.32.1.4 Cable Spreading Room. The cable spreading room shall have an automatic fixed water-based suppression system, and the following criteria also shall be met:

- (1) The location of sprinklers or spray nozzles shall protect cable tray arrangements to ensure water coverage for areas that could present exposure fire hazards to the cable raceways.
- (2) Automatic sprinkler systems shall be designed for a density of 0.30 gpm/ft² (12.2 L/min · m²) over the most remote 2500 ft² (232.2 m²). [804:10.4.1.1]

21.32.1.5* Beneath Turbine Generator Operating Floor. All areas beneath the turbine generator operating floor shall be protected by an automatic sprinkler or foam-water sprinkler system meeting the following criteria:

- (1) The sprinkler system beneath the turbine generator shall be designed around obstructions from structural members and piping.
- (2) The sprinkler system shall be designed to a minimum density of 0.3 gpm/ft² (12.2 L/min · m²) over a minimum application of 5000 ft² (464.5 m²). [804:10.8.2.1]

21.32.1.6* Turbine Generator Bearings.

21.32.1.6.1 Lubricating oil lines above the turbine operating floor shall be protected with an automatic sprinkler system to a minimum density of 0.30 gpm/ft² (12.2 L/min · m²) that covers those areas subject to oil accumulation, including the area within the turbine lagging (skirt). [804:10.8.4]

21.32.1.6.2 Where shaft-driven ventilation systems are used, an automatic preaction sprinkler system providing a density of 0.3 gpm/ft² (12.2 L/min · m²) over the entire area shall be provided. [804:10.8.7(2)]

21.32.1.7 Standby Emergency Diesel Generators and Combustion Turbines. Sprinkler and water spray protection systems shall be designed for a 0.25 gpm/ft² (10.19 L/min · m²) density over the entire area. [804:10.9.3(2)]

21.32.1.8 Fire Pump Room/House. If sprinkler and water spray systems are provided for fire pump houses, they shall be designed for a minimum density of 0.25 gpm/ft² (10.19 L/min · m²) over the entire fire area. [804:10.22.2]

21.32.1.9 Oil-Fired Boilers. Sprinkler and water spray systems shall be designed for a minimum density of 0.25 gpm/ft² (10.19 L/min · m²) over the entire area. [804:10.24.3]

21.32.2 Installation Requirements.

21.32.2.1 Yard Mains, Hydrants, and Building Standpipes. [804:9.4]

21.32.2.1.1 Approved visually indicating sectional control valves such as post-indicator valves shall be provided to isolate portions of the main for maintenance or repair without simultaneously shutting off the supply to both primary and backup fire suppression systems. [804:9.4.2]

21.32.2.1.2* Sectional control valves shall permit maintaining independence of the individual loop around each unit, and the following criteria also shall be met:

- (1) For such installations, common water supplies shall also be permitted to be utilized.
- (2) For multiple-reactor sites with widely separated plants [approaching 1 mi (1.6 km) or more], separate yard fire main loops shall be used. [804:9.4.4]

21.32.2.1.3 Sprinkler systems and manual hose station standpipes shall have connections to the plant underground water main so that a single active failure or a crack in a moderate-energy line can be isolated so as not to impair both the primary and backup fire suppression systems unless otherwise permitted by the following:

- (1) Alternatively, headers fed from each end shall be permitted inside buildings to supply both sprinkler and standpipe systems, provided steel piping and fittings meeting the requirements of ASME B31.1, *Power Piping*, are used for the headers (up to and including the first valve) supplying the sprinkler systems where such headers are part of the seismically analyzed hose standpipe system.
- (2) Where provided, such headers shall be considered an extension of the yard main system.
- (3) Each sprinkler and standpipe system shall be equipped with an outside screw and

yoke (OS&Y) gate valve or other approved shutoff valve. [804:9.4.7]

21.32.2.2 Cable Concentrations. The location of sprinklers or spray nozzles shall protect cable tray arrangements and possible transient combustibles to ensure water coverage for areas that could present exposure fire hazards to the cable raceways. [804:10.4.2.2.3]

21.32.2.3 Turbine Building. Deluge sprinkler systems or deluge spray systems shall meet the following criteria:

- (1) They shall be zoned to limit the area of protection to that which the drainage system can handle with any two adjacent systems actuated.
- (2) They shall be hydraulically designed with each zone calculated with the largest adjacent zone flowing. [804:10.4.2.2.4]

21.33 Light Water Nuclear Power Plants.

21.33.1 Design Requirements. A fire protection water supply of reliability, quantity, and duration shall be provided by one of the two following methods:

- (1) A fire protection water supply of not less than two separate 300,000 gal (1,135,500 L) supplies shall be provided.
- (2) The 2-hour fire flow rate for 2 hours shall be calculated, and the following criteria shall be met:
 - (a) The flow rate shall be based on 500 gpm (1892.5 L/min) for manual hose streams plus the largest design demand of any sprinkler or fixed water spray system(s) in the power block as determined in accordance with NFPA 13 or NFPA 15, *Standard for Water Spray Fixed Systems for Fire Protection*.
 - (b) The fire water supply shall be capable of delivering this design demand with the hydraulically least demanding portion of fire main loop out of service. [805:5.5.1]

21.33.2 Installation Requirements. (Reserved)

21.34 Electric Generating Plants and High Voltage Direct Current Converter Stations. [NFPA 850]

21.34.1* Design Requirements.

21.34.2* Installation Requirements.

21.35 Hydroelectric Generating Plants. [NFPA 851]

21.35.1* Design Requirements.

21.35.2* Installation Requirements.

21.36 Code for the Protection of Cultural Resource Properties — Museums, Libraries, and Places of Worship. [NFPA 909]

21.36.1* Design Requirements.

21.36.1.1* Standard-response sprinklers shall be permitted for use in light-hazard areas. [909:12.4.4.2]

21.36.1.2 System Design for Museums, Libraries, and Their Collections in Compact Storage.

21.36.1.2.1* The design shall recognize the nature of the hazard from a fire that originates in a compact mobile storage unit, where fuel loads are invariably large and fire growth is significantly different from that in other kinds of storage. [909:16.4.8.1.3]

21.36.1.2.2* The automatic fire suppression system, the compact storage system, and the storage compartmentalization features shall be designed to limit fire damage in accordance with the facility's fire safety objectives. [909:16.4.8.1.4.1]

21.36.1.2.3 Design calculations shall include the number and size of the storage modules, the separation provided between the modules end-to-end and back-to-back, and the type of materials being stored. [909:16.4.8.1.4.2]

21.36.1.2.4 Where the automatic suppression is provided by automatic fire sprinkler systems, the systems shall be wet pipe, single interlock pre-action or single noninterlock pre-action systems. [909:16.4.8.1.4.3]

21.36.1.2.5 Dry pipe or double-interlock pre-action systems shall not be installed in compact storage areas. [909:16.4.8.1.4.4]

21.36.1.2.6 Where compact storage is installed in an existing storage area, the existing automatic fire detection and fire suppression systems shall be modified as required to accommodate the increased fire loading. [909:16.4.8.2]

21.36.2 Installation Requirements. (Reserved)

Chapter 22 Plans and Calculations

22.1* Working Plans.

22.1.1* Working plans shall be submitted for approval to the authority having jurisdiction before any equipment is installed or remodeled.

22.1.2 Deviation from approved plans shall require permission of the authority having jurisdiction.

22.1.3 Working plans shall be drawn to an indicated scale, on sheets of uniform size, with a plan of each floor, and shall show those items from the following list that pertain to the design of the system:

- (1) Name of owner and occupant.
- (2) Location, including street address.

- (3) Point of compass.
- (4) Full height cross section, or schematic diagram, including structural member information if required for clarity and including ceiling construction and method of protection for nonmetallic piping.
- (5) Location of partitions.
- (6) Location of fire walls.
- (7) Occupancy class of each area or room.
- (8) Location and size of concealed spaces, closets, attics, and bathrooms.
- (9) Any small enclosures in which no sprinklers are to be installed.
- (10) Size of city main in street and whether dead end or circulating; if dead end, direction and distance to nearest circulating main; and city main test results and system elevation relative to test hydrant (*see A.23.1.8*).
- (11) Other sources of water supply, with pressure or elevation.
- (12) Make, type, model, and nominal K-factor of sprinklers including sprinkler identification number.
- (13) Temperature rating and location of high-temperature sprinklers.
- (14) Total area protected by each system on each floor.
- (15) Number of sprinklers on each riser per floor.
- (16) Total number of sprinklers on each dry pipe system, preaction system, combined dry pipe-preaction system, or deluge system.
- (17) Approximate capacity in gallons of each dry pipe system.
- (18) Pipe type and schedule of wall thickness.
- (19) Nominal pipe size and cutting lengths of pipe (or center-to-center dimensions). Where typical branch lines prevail, it shall be necessary to size only one typical line.
- (20) Location and size of riser nipples.
- (21) Type of fittings and joints and location of all welds and bends. The contractor shall specify on drawing any sections to be shop welded and the type of fittings or formations to be used.
- (22) Type and locations of hangers, sleeves, braces, and methods of securing sprinklers when applicable.
- (23) All control valves, check valves, drain pipes, and test connections.
- (24) Make, type, model, and size of alarm or dry pipe valve.
- (25) Make, type, model, and size of preaction or deluge valve.
- (26) Kind and location of alarm bells.

- (27) Size and location of standpipe risers, hose outlets, hand hose, monitor nozzles, and related equipment.
- (28) Private fire service main sizes, lengths, locations, weights, materials, point of connection to city main; the sizes, types and locations of valves, valve indicators, regulators, meters, and valve pits; and the depth that the top of the pipe is laid below grade.
- (29) Piping provisions for flushing.
- (30) Where the equipment is to be installed as an addition to an existing system, enough of the existing system indicated on the plans to make all conditions clear.
- (31) For hydraulically designed systems, the information on the hydraulic data nameplate.
- (32) A graphic representation of the scale used on all plans.
- (33) Name and address of contractor.
- (34) Hydraulic reference points shown on the plan that correspond with comparable reference points on the hydraulic calculation sheets.
- (35) The minimum rate of water application (density or flow or discharge pressure), the design area of water application, in-rack sprinkler demand, and the water required for hose streams both inside and outside.
- (36) The total quantity of water and the pressure required noted at a common reference point for each system.
- (37) Relative elevations of sprinklers, junction points, and supply or reference points.
- (38) If room design method is used, all unprotected wall openings throughout the floor protected.
- (39) Calculation of loads for sizing and details of sway bracing.
- (40) The setting for pressure-reducing valves.
- (41) Information about backflow preventers (manufacturer, size, type).
- (42) Information about antifreeze solution used (type and amount).
- (43) Size and location of hydrants, showing size and number of outlets and if outlets are to be equipped with independent gate valves. Whether hose houses and equipment are to be provided, and by whom, shall be indicated. Static and residual hydrants that were used in flow tests shall be shown.
- (44) Size, location, and piping arrangement of fire department connections.
- (45) Ceiling/roof heights and slopes not shown in the full height cross section.
- (46) Edition year of NFPA 13 that the sprinkler system is designed to.

22.1.4* A signed copy of the owner's certificate and the working plan submittal shall include the manufacturer's installation instructions for any specially listed equipment, including

descriptions, applications, and limitations for any sprinklers, devices, piping, or fittings.

22.1.5* Working Plans for Automatic Sprinkler Systems with Non-Fire Protection Connections. Special symbols shall be used and explained for auxiliary piping, pumps, heat exchangers, valves, strainers, and the like, clearly distinguishing these devices and piping runs from those of the sprinkler system. Model number, type, and manufacturer's name shall be identified for each piece of auxiliary equipment.

22.2 Water Supply Information.

22.2.1 Water Supply Capacity Information. The following information shall be included:

- (1) Location and elevation of static and residual test gauge with relation to the riser reference point
- (2) Flow location
- (3) Static pressure, psi (bar)
- (4) Residual pressure, psi (bar)
- (5) Flow, gpm (L/min)
- (6) Date
- (7) Time
- (8) Test conducted by or information supplied by
- (9) Other sources of water supply, with pressure or elevation

22.2.2 Water Supply Treatment Information. The following information shall be included where required by 23.1.5:

- (1) Type of condition that requires treatment
- (2) Type of treatment needed to address the problem
- (3) Details of treatment plan

22.3 Hydraulic Calculation Forms.

22.3.1 General. Hydraulic calculations shall be prepared on form sheets that include a summary sheet, detailed worksheets, and a graph sheet. *[See copies of typical forms in Figure A.22.3.2(a), Figure A.22.3.3, and Figure A.22.3.4.]*

22.3.2* Summary Sheet. The summary sheet shall contain the following information, where applicable:

- (1) Date
- (2) Location
- (3) Name of owner and occupant
- (4) Building number or other identification

- (5) Description of hazard (for storage applications, the commodity classification, storage height, and rack configuration shall be included)
- (6) Name and address of contractor or designer
- (7) Name of approving agency
- (8) System design requirements, as follows:
 - (a) Design area of water application, ft² (m²)
 - (b) Minimum rate of water application (density), gpm/ft² (mm/min). Where sprinklers are listed with minimum water application in gpm (L/min) or pressure in psi (bar), the minimum rate of water application shall be indicated in gpm (L/min) or pressure, psi (bar).
 - (c) Area per sprinkler, ft² (m²)
- (9) Total water requirements as calculated, including allowance for inside hose, outside hydrants, and water curtain and exposure sprinklers
- (10) Allowance for in-rack sprinklers, gpm (L/min)
- (11) Limitations (dimension, flow, and pressure) on extended coverage or other listed special sprinklers

22.3.3* Detailed Worksheets. Detailed worksheets or computer printout sheets shall contain the following information:

- (1) Sheet number
- (2) Sprinkler description and discharge constant (*K*)
- (3) Hydraulic reference points
- (4) Flow in gpm (L/min)
- (5) Pipe size
- (6) Pipe lengths, center-to-center of fittings
- (7) Equivalent pipe lengths for fittings and devices
- (8) Friction loss in psi/ft (bar/m) of pipe
- (9) Total friction loss between reference points
- (10) In-rack sprinkler demand balanced to ceiling demand
- (11) Elevation head in psi (bar) between reference points
- (12) Required pressure in psi (bar) at each reference point
- (13) Velocity pressure and normal pressure if included in calculations
- (14) Notes to indicate starting points or reference to other sheets or to clarify data shown
- (15)* Diagram to accompany gridded system calculations to indicate flow quantities and

directions for lines with sprinklers operating in the remote area

- (16) Combined K-factor calculations for sprinklers on drops, armovers, or sprigs where calculations do not begin at the sprinkler

22.3.4* Graph Sheet. A graphic representation of the complete hydraulic calculation shall be plotted on semiexponential graph paper ($Q^{1.85}$) and shall include the following:

- (1) Water supply curve
- (2) Sprinkler system demand
- (3) Hose allowance (where applicable)
- (4) In-rack sprinkler demand (where applicable)

22.3.5 Computer Generated Hydraulic Reports.

22.3.5.1* General. Hydraulic calculations shall be prepared on form sheets that include a summary sheet, a graph sheet, a water supply analysis, a node analysis and detailed worksheets. The data shall be presented in the order shown in Figure 22.3.5.1(a), Figure 22.3.5.1(b), Figure 22.3.5.1(c), and Figure 22.3.5.1(d). The requirement of 22.3.5 shall be effective starting January 1, 2008.

HYDRAULIC CALCULATIONS
for

Project name: _____

Location: _____

Drawing no.: _____ Date: _____

Design

Remote area number: _____

Remote area location: _____

Occupancy classification: _____

Density: _____ gpm/ft²

Area of application: _____ ft²

Coverage per sprinkler: _____ ft²

Type of sprinklers calculated: _____

No. of sprinklers calculated: _____

In-rack demand: _____

Hose streams: _____

Total water required (including hose streams): _____ gpm @ _____ psi

Type of system: _____

Volume of dry or preaction system: _____ gal

Water supply information

Date: _____

Location: _____

Source: _____

Name of contractor: _____

Address: _____

Phone number: _____

Name of designer: _____

Authority having jurisdiction: _____

Notes: (Include peaking information or gridded systems here.) _____

FIGURE 22.3.5.1(a) Summary Sheet.

FLOW TEST SUMMARY SHEET

$N^{1.85}$

Contract name and number: _____

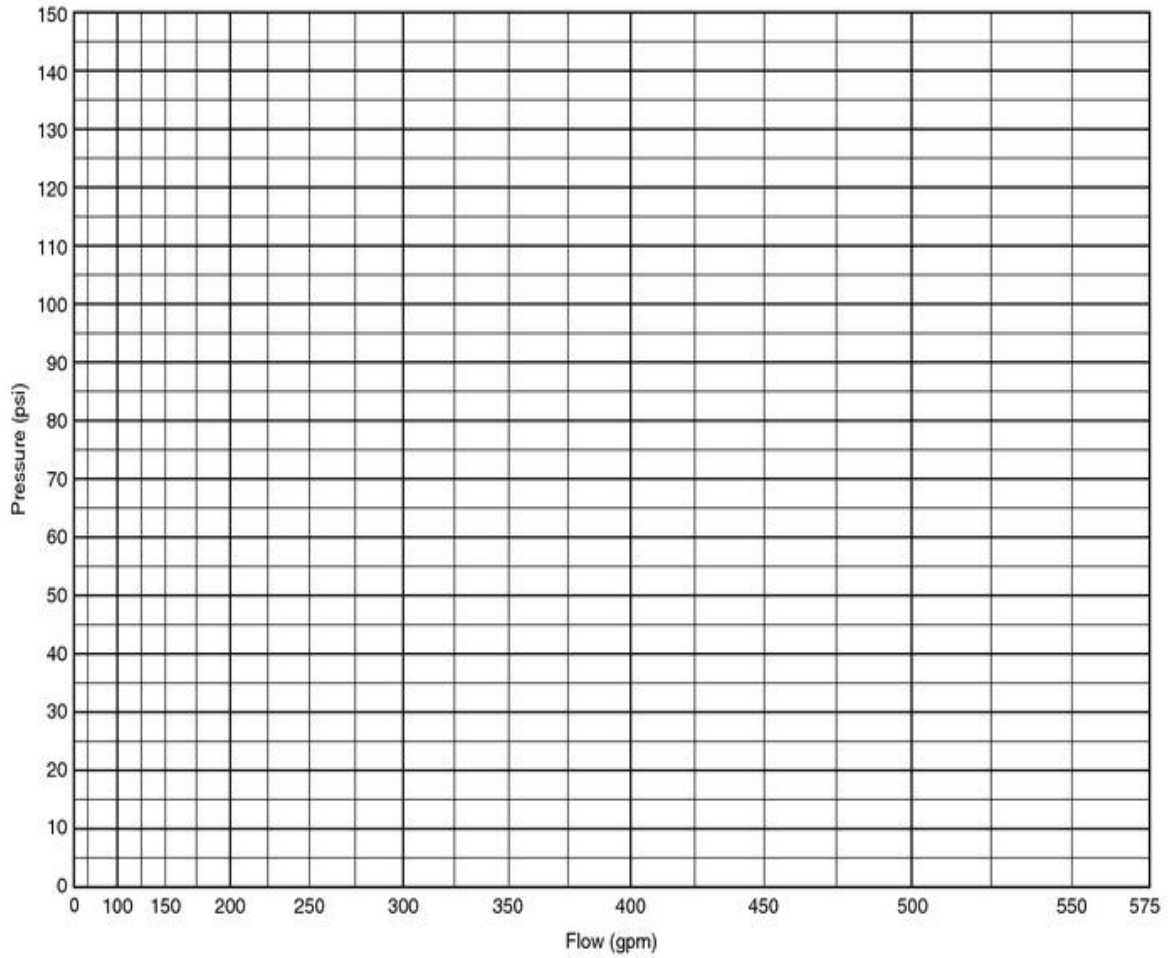

Notes: _____

FIGURE 22.3.5.1(b) Graph Sheet.

FIGURE 22.3.5.1(c) Supply and Node Analyst Sheet.

Job name: _____ Sheet number: _____

PIPE INFORMATION

Node 1	Elev 1 (ft)	K factor	Flow added —this step (q)	Nominal ID	Fittings— quantity and length	L ft	C Factor	total (Pt)	NOTES
	Node 2		Elev 2 (ft)	Total flow (Q)		Actual ID	F ft	Pf per foot (psi)	
T ft		friect (Pf)							
data 1	data 1	data 1	data 1	data	data	data	data	data 1	data
data 2	data 2		data	data	data	data	data	data	
data 2	data 2		data	data	data	data	data	data	
data 1	data 1	data 1	data 1	data	data	data	data	data 1	data
data 2	data 2		data	data	data	data	data	data	
data 2	data 2		data	data	data	data	data	data	
data 1	data 1	data 1	data 1	data	data	data	data	data 1	data
data 2	data 2		data	data	data	data	data	data	
data 2	data 2		data	data	data	data	data	data	
data 1	data 1	data 1	data 1	data	data	data	data	data 1	data
data 2	data 2		data	data	data	data	data	data	
data 2	data 2		data	data	data	data	data	data	
data 1	data 1	data 1	data 1	data	data	data	data	data 1	data
data 2	data 2		data	data	data	data	data	data	
data 2	data 2		data	data	data	data	data	data	
data 1	data 1	data 1	data 1	data	data	data	data	data 1	data
data 2	data 2		data	data	data	data	data	data	
data 2	data 2		data	data	data	data	data	data	

FIGURE 22.3.5.1(d) Detailed Work Sheet.

22.3.5.2 Summary Sheet. [See Figure 22.3.5.1(a).] The summary sheet shall contain the following information, where applicable:

- (1) Project name and date
- (2) Location (including street address)
- (3) Drawing number
- (4) Remote area number
- (5) Remote area location
- (6) Occupancy or commodity classification
- (7) System design requirements, as follows:
 - (a) Design area of water application, ft² (m²)
 - (b) Minimum rate of water application (density), gpm/ft² (mm/min)
 - (c) Area per sprinkler, ft² (m²)
- (8) Total water requirements as calculated, including allowance for inside hose, outside hydrants, water curtain and exposure sprinklers, and allowance for in-rack sprinklers, gpm (L/min)
- (9) Type of system and, if dry or preaction, the volume of the system in gallons (liters)
- (10) Water supply information, including the following:
 - (a) Date
 - (b) Location
 - (c) Source
 - (d) Elevation relative to finished floor
- (11) Name and address of installing contractor
- (12) Name of designer
- (13) Authority having jurisdiction
- (14) Notes that include items such as peaking information for calculations performed by a computer program, limitations (dimension, flow, and pressure) on extended coverage or other listed special sprinklers

22.3.5.3 Graph Sheet. [See Figure 22.3.5.1(b).] A graphic representation of the complete hydraulic calculation shall be plotted on semiexponential graph paper ($Q^{1.85}$) and shall include the following:

- (1) Water supply curve
- (2) Sprinkler system demand

- (3) Hose demand (where applicable)
- (4) In-rack sprinkler demand (where applicable)
- (5) Additional pressures supplied by a fire pump or other source (when applicable)

22.3.5.4 Supply Analysis. [See Figure 22.3.5.1(c).] Information summarized from the graph sheet shall include the following:

- (1) Node tag at the source
- (2) Static pressure [psi (bar)] available at the source
- (3) Residual pressure [psi (bar)] available at the source
- (4) Total flow [gpm (L/min)] available at the source
- (5) Available pressure [psi (bar)] at the source when the total calculated demand is flowing
- (6) Total calculated demand [gpm (L/min)] at the source
- (7) Required pressure [psi (bar)] when flowing total calculated demand

22.3.5.5 Node Analysis. [See Figure 22.3.5.1(d).] Organized information regarding the node tags given to each hydraulic reference point on the system as indicated on the shop drawings shall include the following information:

- (1) Node tag for each specific point on the system used in the hydraulic calculations
- (2) Elevation in ft (m) of each node tag
- (3) K-factor of flowing nodes (such as sprinklers)
- (4) Hose allowance in gpm (L/min) requirements for the node tag
- (5) Pressure in psi (bar) at the node
- (6) Discharge in gpm (L/min) calculated at the node
- (7) Notes that indicate any special requirements for the node

22.3.5.6 Detailed Worksheets. Detailed worksheets or computer printout sheets shall contain the following information:

- (1) Sheet number
- (2) Hydraulic reference points used in each step
- (3) Elevation in ft (m) at each hydraulic reference point
- (4) Sprinkler description and discharge constant (*K*) for the flowing reference point
- (5) Flow in gpm (L/min) for the flowing reference point (when applicable)
- (6) Total flow in gpm (L/min) through each step
- (7) Nominal pipe size in in. (mm)

- (8) Actual internal diameter of pipe in in. (mm)
- (9) Quantity and length in ft (m), of each type of fitting and device
- (10) Pipe lengths in ft (m), center-to-center of fittings
- (11) Equivalent pipe lengths in ft (m), of fittings and devices for the step
- (12) Total equivalent length in ft (m) of pipes and fitting for the step
- (13) C-factor used in each step
- (14) Friction loss in psi/ft (bar/m) of pipe
- (15) Sum of the pressures from the previous step (starting pressure at beginning)
- (16) Elevation head in psi (bar) between reference points
- (17) Total friction loss in psi (bar) between reference points
- (18) Required pressure in psi (bar) at each reference point
- (19) Notes and other information shall include the following:
 - (a) Velocity pressure and normal pressure if included in calculations
 - (b) In-rack sprinkler demand balanced to ceiling demand
 - (c) Notes to indicate starting points or reference to other sheets or to clarify data shown
 - (d) Diagram to accompany gridded system calculations to indicate flow quantities and directions for lines with sprinklers operating in the remote area
 - (e) Combined K-factor calculations for sprinklers on drops, armovers, or sprigs where calculations do not begin at the sprinkler
 - (f) The pressure (psi) loss assigned the backflow device when included on a system

22.4 Hydraulic Calculation Procedures.

22.4.1* General.

22.4.1.1 A calculated system for a building, or a calculated addition to a system in an existing sprinklered building, shall supersede the rules in this standard governing pipe schedules, except that all systems shall continue to be limited by area.

22.4.1.2 Pipe sizes shall be no less than 1 in. (25 mm) nominal for ferrous piping and $\frac{3}{4}$ in. (20 mm) nominal for copper tubing or nonmetallic piping listed for fire sprinkler service.

22.4.1.3 The size of pipe, number of sprinklers per branch line, and number of branch lines per cross main shall otherwise be limited only by the available water supply.

22.4.1.4 However, sprinkler spacing and all other rules covered in this and other applicable standards shall be observed.

22.4.1.5 Hydraulic calculations shall extend to the effective point of the water supply where

the characteristics of the water supply are known.

22.4.2 Formulas.

22.4.2.1 Friction Loss Formula.

22.4.2.1.1 Pipe friction losses shall be determined on the basis of the Hazen–Williams formula, as follows:

$$p = \frac{4.52Q^{1.85}}{C^{1.85}d^{4.87}}$$

where:

p = frictional resistance in psi per foot of pipe

Q = flow in gpm

C = friction loss coefficient

d = actual internal diameter of pipe in inches

22.4.2.1.2 For SI units, the following equation shall be used:

$$p_m = 6.05 \left(\frac{Q_m^{1.85}}{C^{1.85}d_m^{4.87}} \right) 10^5$$

where:

p_m = frictional resistance in bar per meter of pipe

Q_m = flow in L/min

C = friction loss coefficient

d_m = actual internal diameter in mm

22.4.2.1.3 For antifreeze solutions greater than 40 gal in size, the friction loss shall also be calculated using the Darcy–Weisbach formula:

$$\Delta P = 0.000216 f \frac{l \rho Q^2}{d^5}$$

where:

ΔP = friction loss (psi)

f = friction loss factor from Moody diagram

l = length of pipe or tube (ft)

ρ = density of fluid (lb/ft³)

Q = flow in pipe or tube (gpm)

d = inside diameter of tube (inches)

22.4.2.2 Velocity Pressure Formula. Velocity pressure shall be determined on the basis of the following formula:

$$P_v = \frac{0.001123Q^2}{D^5}$$

where:

P_v = velocity pressure in psi (SI: 1 psi = 0.0689 bar)

Q = flow in gpm (SI : 1 gal = 3.785 L)

D = inside diameter in inches (SI: 1 in. = 25.4 mm)

22.4.2.3 Normal Pressure Formula. Normal pressure (P_n) shall be determined on the basis of the following formula:

$$P_n = P_t - P_v$$

where:

P_n = normal pressure

P_t = total pressure in psi (bar)

P_v = velocity pressure in psi (bar)

22.4.2.4 Hydraulic Junction Points.

22.4.2.4.1 Pressures at hydraulic junction points shall balance within 0.5 psi (0.03 bar).

22.4.2.4.2 The highest pressure at the junction point, and the total flows as adjusted, shall be carried into the calculations.

22.4.2.4.3 Pressure balancing shall be permitted through the use of a K-factor developed for branch lines or portions of systems using $K_p = Q/(p)^{0.5}$.

22.4.3 Equivalent Pipe Lengths of Valves and Fittings.

22.4.3.1 Pipe and Fittings.

22.4.3.1.1 Table 22.4.3.1.1 shall be used to determine the equivalent length of pipe for fittings and devices unless manufacturer's test data indicate that other factors are appropriate.

Table 22.4.3.1.1 Equivalent Schedule 40 Steel Pi

Fittings and Valves	Fittings and Valves Expressed in Equivalent								
	½ in. (15 mm)	¾ in. (20 mm)	1 in. (25 mm)	1¼ in. (32 mm)	1½ in. (40 mm)	2 in. (50 mm)	2½ in. (65 mm)	3 in. (80 mm)	3½ in. (90 mm)
45° elbow	—	1 (0.3)	1 (0.3)	1 (0.3)	2 (0.6)	2 (0.6)	3 (0.9)	3 (0.9)	3 (0.9)
90° standard elbow	1 (0.3)	2 (0.6)	2 (0.6)	3 (0.9)	4 (1.2)	5 (1.5)	6 (1.8)	7 (2.1)	8 (2.4)
90° long-turn elbow	0.5 (0.2)	1 (0.3)	2 (0.6)	2 (0.6)	2 (0.6)	3 (0.9)	4 (1.2)	5 (1.5)	5 (1.5)
Tee or cross (flow turned 90°)	3 (0.9)	4 (1.2)	5 (1.5)	6 (1.8)	8 (2.4)	10 (3)	12 (3.7)	15 (4.6)	17 (5.2)

Table 22.4.3.1.1 Equivalent Schedule 40 Steel Pi

Fittings and Valves	Fittings and Valves Expressed in Equivalent								
	½ in. (15 mm)	¾ in. (20 mm)	1 in. (25 mm)	1¼ in. (32 mm)	1½ in. (40 mm)	2 in. (50 mm)	2½ in. (65 mm)	3 in. (80 mm)	3½ in. (90 mm)
Butterfly valve	—	—	—	—	—	6 (1.8)	7 (2.1)	10 (3)	—
Gate valve	—	—	—	—	—	1 (0.3)	1 (0.3)	1 (0.3)	1 (0.3)
Swing check*	—	—	5 (1.5)	7 (2.1)	9 (2.7)	11 (3.4)	14 (4.3)	16 (4.9)	19 (5.8)

For SI units, 1 in. = 25.4 mm; 1 ft = 0.3048 m.

Note: Information on ½ in. pipe is included in this table only because it is allowed under 8.15.19.4 and 8.15.19

*Due to the variation in design of swing check valves, the pipe equivalents indicated in this table are considere

22.4.3.1.2 For saddle-type fittings having friction loss greater than that shown in Table 22.4.3.1.1, the increased friction loss shall be included in hydraulic calculations.

22.4.3.1.3 Equivalent Length Modifier.

22.4.3.1.3.1 For internal pipe diameters different from Schedule 40 steel pipe [Schedule 30 for pipe diameters 8 in. (200 mm) and larger], the equivalent length shown in Table 22.4.3.1.1 shall be multiplied by a factor derived from the following formula:

$$\left(\frac{\text{Actual inside diameter}}{\text{Schedule 40 steel pipe inside diameter}} \right)^{4.87} = \text{Factor}$$

22.4.3.1.3.2 The factor thus obtained shall be further modified as required by Table 22.4.3.1.1. This table shall apply to other types of pipe listed in Table 22.4.3.1.1 only where modified by factors from 22.4.3.1.1 and 22.4.3.2.

22.4.3.2 C Factors. Table 22.4.3.1.1 shall be used with a Hazen–Williams C factor of 120 only. For other values of C, the values in Table 22.4.3.1.1 shall be multiplied by the factors indicated in Table 22.4.3.2.

Table 22.4.3.2 C Value Multiplier

Value of C	100	130	140	150
Multiplying factor	0.713	1.16	1.33	1.51

Note: These factors are based upon the friction loss through the fitting being independent of the C factor available to the piping.

22.4.3.3 Valves. Specific friction loss values or equivalent pipe lengths for alarm valves, dry pipe valves, deluge valves, strainers, and other devices shall be made available to the authority having jurisdiction.

22.4.3.4 Differing Values. Specific friction loss values or equivalent pipe lengths for listed fittings not in Table 6.4.1 shall be used in hydraulic calculations where these losses or

equivalent pipe lengths are different from those shown in Table 22.4.3.1.1.

22.4.4* Calculation Procedure.

22.4.4.1* For all systems the design area shall be the hydraulically most demanding based on the criteria of Chapter 11, Chapter 12, or the special design approaches in accordance with the requirements of Chapter 21.

22.4.4.1.1 Density–Area Method.

22.4.4.1.1.1 Where the design is based on the density–area method, the design area shall be a rectangular area having a dimension parallel to the branch lines at least 1.2 times the square root of the area of sprinkler operation (*A*) used, which shall permit the inclusion of sprinklers on both sides of the cross main.

22.4.4.1.1.2 Any fractional sprinkler shall be carried to the next higher whole sprinkler.

22.4.4.1.1.3 In systems having branch lines with an insufficient number of sprinklers to fulfill the 1.2 requirement, the design area shall be extended to include sprinklers on adjacent branch lines supplied by the same cross main.

22.4.4.1.2 Room Design Method. Where the design is based on the room design method, the calculation shall be based on the room and communicating space, if any, that is hydraulically the most demanding. (*See 11.2.3.3.*)

22.4.4.2 Large Drop Sprinkler and Specific Application Control Mode Sprinkler Method.

22.4.4.2.1 For large drop sprinklers and specific application control mode sprinklers, the design area shall be a rectangular area having a dimension parallel to the branch lines at least 1.2 times the square root of the area protected by the number of sprinklers to be included in the design area.

22.4.4.2.2 Any fractional sprinkler shall be carried to the next higher whole sprinkler.

22.4.4.3 ESFR Sprinkler Method.

22.4.4.3.1 For ESFR sprinklers, the design area shall consist of the most hydraulically demanding area of 12 sprinklers, consisting of four sprinklers on each of three branch lines, unless other specific numbers of design sprinklers are required in other sections of this standard. The final design shall include a minimum of 960 ft² (89 m²).

22.4.4.4* Gridded Systems.

22.4.4.4.1 For gridded systems, the designer shall verify that the hydraulically most demanding area is being used.

22.4.4.4.2* A minimum of two additional sets of calculations shall be submitted to demonstrate peaking of demand area friction loss when compared to areas immediately adjacent on either side along the same branch lines, unless the requirements of 22.4.4.4.3 are met.

22.4.4.4.3 Computer programs that show the peaking of the demand area friction loss shall

be acceptable based on a single set of calculations.

22.4.4.5 Design Densities.

22.4.4.5.1* For antifreeze solutions greater than 40 gal (151 L) in size, the friction loss shall also be calculated using the Darcy–Weisbach equation shown in 22.4.2.1.3 using a Moody diagram, ϵ -factors that are representative of aged pipe, and adjusted K-factors for fluid properties.

22.4.4.5.2 System piping shall be hydraulically designed using design densities and areas of operation in accordance with 11.2.3.2 or Chapter 12 as required for the occupancies or hazards involved.

22.4.4.5.3* The density shall be calculated on the basis of floor area of sprinkler operation. Where sprinklers are installed under a sloped ceiling, the area used for this calculation shall be the horizontal plane below the sprinklers.

22.4.4.5.4 The area covered by any sprinkler used in hydraulic design and calculations shall be the horizontal distances measured between the sprinklers on the branch line and between the branch lines in accordance with 8.5.2.

22.4.4.5.5* Where sprinklers are installed above and below a ceiling or in a case where more than two areas are supplied from a common set of branch lines, the branch lines and supplies shall be calculated to supply the largest water demand.

22.4.4.5.6* For sloped ceiling applications, the area of sprinkler application for density calculations shall be based upon the projected horizontal area.

22.4.4.6* Design Area Sprinklers.

22.4.4.6.1 Each sprinkler in the design area and the remainder of the hydraulically designed system shall discharge at a flow rate at least equal to the stipulated minimum water application rate (density) multiplied by the area of sprinkler operation. Where sprinklers are required to discharge a specific flow or pressure rather than a density, each sprinkler in the design area shall discharge at a flow or pressure at least equal to the minimum required.

22.4.4.6.2 The requirements of 22.4.4.6.1 to include every sprinkler in the design area to be included in the system discharge shall not apply where the area of application is equal to or greater than the minimum allowable area of Figure 11.2.3.1.1 for the appropriate hazard classification (including a 30 percent increase for dry pipe systems). Sprinkler discharge in closets, washrooms, and similar small compartments requiring only one sprinkler shall be permitted to be omitted from hydraulic calculations within the area of application. Sprinklers in these small compartments shall, however, be capable of discharging minimum densities in accordance with Figure 11.2.3.1.1.

22.4.4.6.3 The requirements of 22.4.4.6.1 to include every sprinkler in the design area to be included in the system discharge shall not apply where spray sprinklers and large drop sprinklers are provided above and below obstructions such as wide ducts or tables. The water supply for one of the levels of sprinklers shall be permitted to be omitted from the hydraulic ceiling design calculations within the area of application.

22.4.4.6.4 The requirements of 22.4.4.6.1 to include every sprinkler in the design area to be included in the system discharge shall not apply; where ESFR sprinklers are installed above and below obstructions, the discharge for up to two sprinklers from one of the levels shall be included with those of the other level in the hydraulic calculation.

22.4.4.6.5 Water demand of sprinklers installed in concealed spaces or under obstructions such as ducts and cutting tables need not be added to ceiling demand.

22.4.4.6.6 Calculations shall begin at the hydraulically most remote sprinkler.

22.4.4.6.7 The calculated pressure at each sprinkler shall be used to determine the discharge flow rate for that particular sprinkler.

22.4.4.6.8 Where sprinklers are installed under a sloped ceiling, the area shall be calculated on a horizontal plane below the sprinklers.

22.4.4.7 Friction Loss. Pipe friction loss shall be calculated in accordance with the Hazen–Williams formula with *C* values from Table 22.4.4.7, as follows:

- (1) Include pipe, fittings, and devices such as valves, meters, flow switches in pipes 2 in. or less in size, and strainers, and calculate elevation changes that affect the sprinkler discharge.
- (2) Tie-in drain piping shall not be included in the hydraulic calculations.
- (3) Calculate the loss for a tee or a cross where flow direction change occurs based on the equivalent pipe length of the piping segment in which the fitting is included.
- (4) The tee at the top of a riser nipple shall be included in the branch line, the tee at the base of a riser nipple shall be included in the riser nipple, and the tee or cross at a cross main-feed main junction shall be included in the cross main.
- (5) Do not include fitting loss for straight-through flow in a tee or cross.
- (6) Calculate the loss of reducing elbows based on the equivalent feet value of the smallest outlet.
- (7) Use the equivalent feet value for the standard elbow on any abrupt 90 degree turn, such as the screw-type pattern.
- (8) Use the equivalent feet value for the long-turn elbow on any sweeping 90 degree turn, such as a flanged, welded, or mechanical joint-elbow type. (*See Table 22.4.3.1.1.*)
- (9) Friction loss shall be excluded for the fitting directly connected to a sprinkler.
- (10) Losses through a pressure-reducing valve shall be included based on the normal inlet pressure condition. Pressure loss data from the manufacturer's literature shall be used.

Table 22.4.4.7 Hazen–Williams *C* Values

Pipe or Tube	<i>C</i> Value*
--------------	-----------------

Table 22.4.4.7 Hazen–Williams C Values

Pipe or Tube	C Value*
Unlined cast or ductile iron	100
Black steel (dry systems including preaction)	100
Black steel (wet systems including deluge)	120
Galvanized (all)	120
Plastic (listed) all	150
Cement-lined cast or ductile iron	140
Copper tube or stainless steel	150
Asbestos cement	140
Concrete	140

*The authority having jurisdiction is permitted to consider other C values.

22.4.4.8* Orifice Plates.

22.4.4.8.1 Orifice plates shall not be used for balancing the system.

22.4.4.8.2 Unless the requirements of 22.4.4.8.3 or 22.4.4.8.4 are met, mixing of sprinklers of different orifice sizes by reducing the orifice size of adjacent sprinklers on the same branch line leading back to the main for the purpose of minimizing sprinkler over discharge shall not be permitted.

22.4.4.8.3 Sprinklers with different orifice sizes shall be acceptable for special use such as exposure protection, small rooms or enclosures, or directional discharge. *(See 3.3.15 for definition of small rooms.)*

22.4.4.8.4 Extended-coverage and residential sprinklers with a different orifice size shall be acceptable for part of the protection area where installed in accordance with their listing.

22.4.4.9* Pressures.

22.4.4.9.1 When calculating flow from an orifice, the total pressure (P_t) shall be used, unless the calculation method of 22.4.4.9.2 is utilized.

22.4.4.9.2 Use of the normal pressure (P_n) calculated by subtracting the velocity pressure from the total pressure shall be permitted. Where the normal pressure is used, it shall be used on all branch lines and cross mains where applicable.

22.4.4.9.3 Flow from a sprinkler shall be calculated using the nominal K-factor.

22.4.4.10 Minimum Operating Pressure.

22.4.4.10.1 Minimum operating pressure of any sprinkler shall be 7 psi (0.5 bar).

22.4.4.10.2 Where a higher minimum operating pressure for the desired application is specified in the listing of the sprinkler, this higher pressure shall be required.

22.4.4.11 Maximum Operating Pressure. For extra hazard occupancies, palletized, solid-pile, in bin box, on shelf storage, the maximum operating pressure of any sprinkler shall be 175 psi (12.1 bar).

22.5 Pipe Schedules.

Pipe schedules shall not be used, except in existing systems and in new systems or extensions to existing systems described in Chapter 11. Water supplies shall conform to 11.2.2.

22.5.1* General.

22.5.1.1 The pipe schedule sizing provisions shall not apply to hydraulically calculated systems.

22.5.1.2 Sprinkler systems having sprinklers with K-factors other than 5.6 nominal, listed piping material other than that covered in Table 6.3.1.1, extra hazard Group 1 and Group 2 systems, and exposure protection systems shall be hydraulically calculated.

22.5.1.3 The number of automatic sprinklers on a given pipe size on one floor shall not exceed the number given in 22.5.2, 22.5.3, or 22.5.4 for a given occupancy.

22.5.1.4* Size of Risers. Each system riser shall be sized to supply all sprinklers on the riser on any one floor as determined by the standard schedules of pipe sizes in 22.5.2, 22.5.3, or 22.5.4.

22.5.1.5 Slatted Floors, Large Floor Openings, Mezzanines, and Large Platforms.

Buildings having slatted floors or large unprotected floor openings without approved stops shall be treated as one area with reference to pipe sizes, and the feed mains or risers shall be of the size required for the total number of sprinklers.

22.5.1.6 Stair Towers. Stairs, towers, or other construction with incomplete floors, if piped on independent risers, shall be treated as one area with reference to pipe sizes.

22.5.2 Schedule for Light Hazard Occupancies.

22.5.2.1 Branch Lines.

22.5.2.1.1 Unless permitted by 22.5.2.1.2 or 22.5.2.1.3, branch lines shall not exceed eight sprinklers on either side of a cross main.

22.5.2.1.2 Where more than eight sprinklers on a branch line are necessary, lines shall be permitted to be increased to nine sprinklers by making the two end lengths 1 in. (25.4 mm) and 1¼ in. (33 mm), respectively, and the sizes thereafter standard.

22.5.2.1.3 Ten sprinklers shall be permitted to be placed on a branch line, making the two end lengths 1 in. (25.4 mm) and 1¼ in. (33 mm), respectively, and feeding the tenth sprinkler by a 2½ in. (64 mm) pipe.

22.5.2.2 Pipe Sizes.

end lengths 1 in. (25.4 mm) and 1¼ in. (33 mm), respectively, and feeding the tenth sprinkler by a 2½ in. (64 mm) pipe.

22.5.2.2 Pipe Sizes.

22.5.2.2.1 Pipe sizes shall be in accordance with Table 22.5.2.2.1.

Table 22.5.2.2.1 Light Hazard Pipe Schedules

Steel		Copper	
1 in.	2 sprinklers	1 in.	2 sprinklers
1¼ in.	3 sprinklers	1¼ in.	3 sprinklers
1½ in.	5 sprinklers	1½ in.	5 sprinklers
2 in.	10 sprinklers	2 in.	12 sprinklers
2½ in.	30 sprinklers	2½ in.	40 sprinklers
3 in.	60 sprinklers	3 in.	65 sprinklers
3½ in.	100 sprinklers	3½ in.	115 sprinklers
4 in.	See Section 8.2	4 in.	See Section 8.2

For SI units, 1 in. = 25.4 mm.

22.5.2.2.2 Each area requiring more sprinklers than the number specified for 3½ in. (89 mm) pipe in Table 22.5.2.2.1 and without subdividing partitions (not necessarily fire walls) shall be supplied by mains or risers sized for ordinary hazard occupancies.

22.5.2.3 Where sprinklers are installed above and below ceilings in accordance with Figure 22.5.2.3(a) through Figure 22.5.2.3(c), and such sprinklers are supplied from a common set of branch lines or separate branch lines from a common cross main, such branch lines shall not exceed eight sprinklers above and eight sprinklers below any ceiling on either side of the cross main.

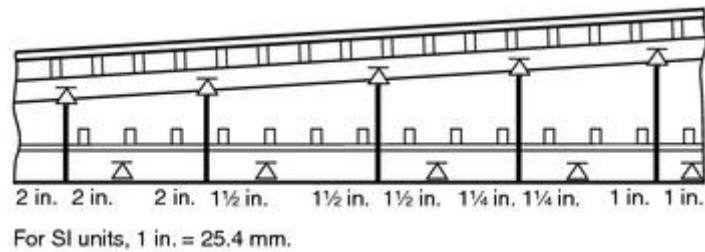

FIGURE 22.5.2.3(a) Arrangement of Branch Lines Supplying Sprinklers Above and Below a Ceiling.

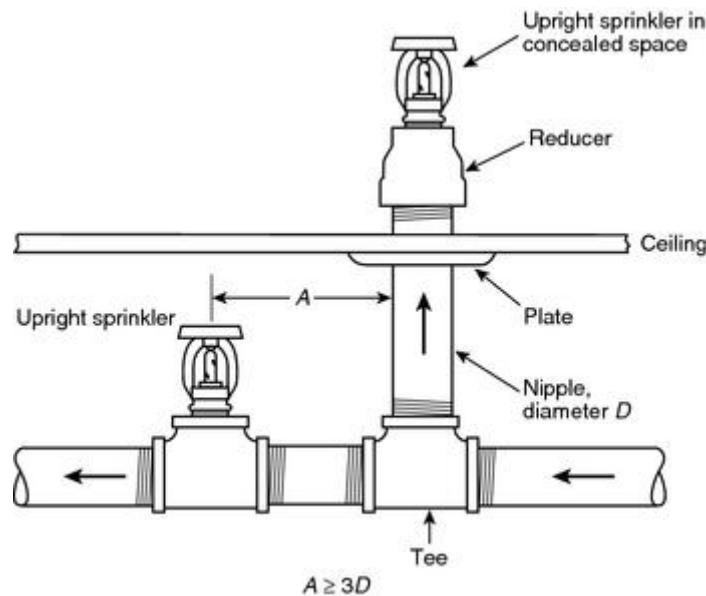

FIGURE 22.5.2.3(b) Sprinkler on Riser Nipple from Branch Line in Lower Fire Area.

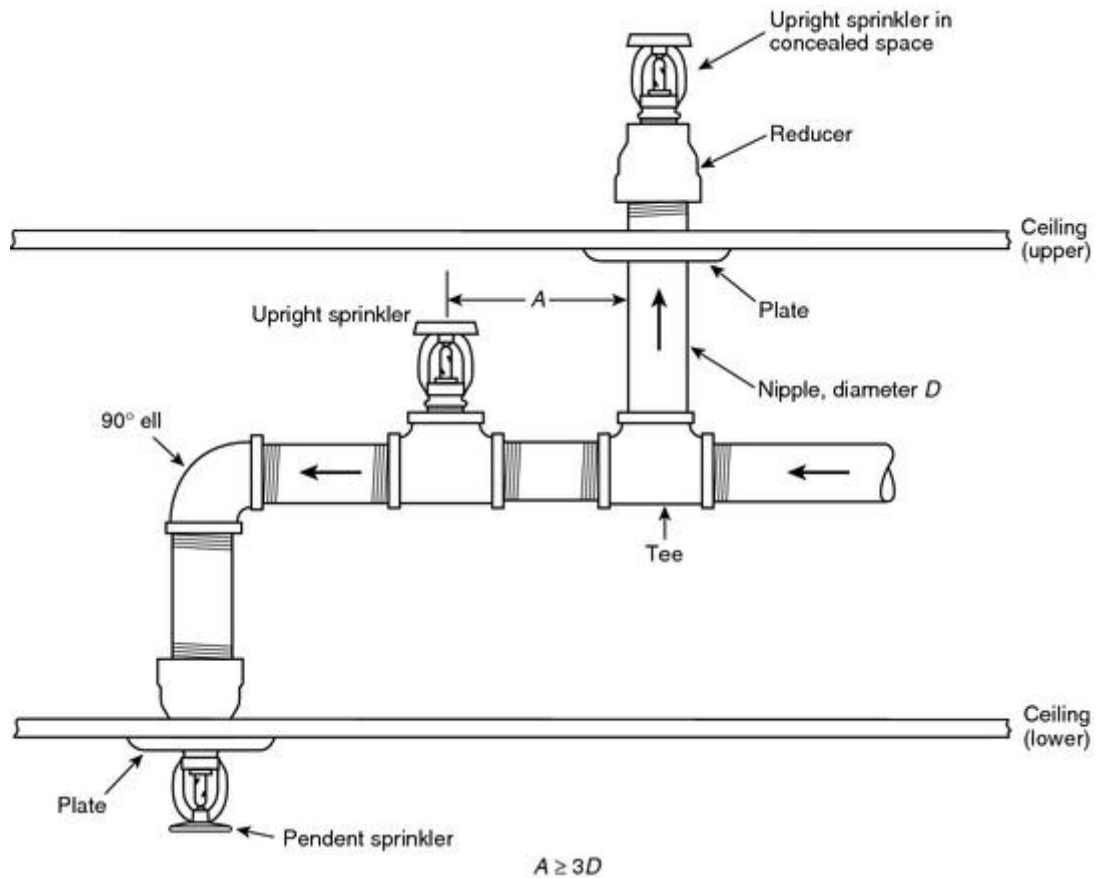

FIGURE 22.5.2.3(c) Arrangement of Branch Lines Supplying Sprinklers Above, in Between, and Below Ceilings.

22.5.2.4 Unless the requirements of 22.5.2.5 are met, pipe sizing up to and including 2 ½ in. (64 mm) shall be as shown in Table 22.5.2.4 utilizing the greatest number of sprinklers to be found on any two adjacent levels.

Table 22.5.2.4 Number of Sprinklers Above and Below a Ceiling

Steel		Copper	
1 in.	2 sprinklers	1 in.	2 sprinklers
1¼ in.	4 sprinklers	1¼ in.	4 sprinklers
1½ in.	7 sprinklers	1½ in.	7 sprinklers
2 in.	15 sprinklers	2 in.	18 sprinklers
2½ in.	50 sprinklers	2½ in.	65 sprinklers

For SI units, 1 in. = 25.4 mm.

22.5.2.5 Branch lines and cross mains supplying sprinklers installed entirely above or entirely below ceilings shall be sized in accordance with Table 22.5.2.2.1.

22.5.2.6* Where the total number of sprinklers above and below a ceiling exceeds the number specified in Table 22.5.2.2.1 for 2½ in. (64 mm) pipe, the pipe supplying such

sprinklers shall be increased to 3 in. (76 mm) and sized thereafter according to the schedule shown in Table 22.5.2.2.1 for the number of sprinklers above or below a ceiling, whichever is larger.

22.5.3 Schedule for Ordinary Hazard Occupancies.

22.5.3.1 Unless permitted by 22.5.3.2 or 22.5.3.3, branch lines shall not exceed eight sprinklers on either side of a cross main.

22.5.3.2 Where more than eight sprinklers on a branch line are necessary, lines shall be permitted to be increased to nine sprinklers by making the two end lengths 1 in. (25.4 mm) and 1¼ in. (33 mm), respectively, and the sizes thereafter standard.

22.5.3.3 Ten sprinklers shall be permitted to be placed on a branch line, making the two end lengths 1 in. (25.4 mm) and 1¼ in. (33 mm), respectively, and feeding the tenth sprinkler by a 2½ in. (64 mm) pipe.

22.5.3.4 Pipe sizes shall be in accordance with Table 22.5.3.4.

Table 22.5.3.4 Ordinary Hazard Pipe Schedule

Steel		Copper	
1 in.	2 sprinklers	1 in.	2 sprinklers
1¼ in.	3 sprinklers	1¼ in.	3 sprinklers
1½ in.	5 sprinklers	1½ in.	5 sprinklers
2 in.	10 sprinklers	2 in.	12 sprinklers
2½ in.	20 sprinklers	2½ in.	25 sprinklers
3 in.	40 sprinklers	3 in.	45 sprinklers
3½ in.	65 sprinklers	3½ in.	75 sprinklers
4 in.	100 sprinklers	4 in.	115 sprinklers
5 in.	160 sprinklers	5 in.	180 sprinklers
6 in.	275 sprinklers	6 in.	300 sprinklers
8 in.	See Section 8.2	8 in.	See Section 8.2

For SI units, 1 in. = 25.4 mm.

22.5.3.5 Where the distance between sprinklers on the branch line exceeds 12 ft (3.7 m) or the distance between the branch lines exceeds 12 ft (3.7 m), the number of sprinklers for a given pipe size shall be in accordance with Table 22.5.3.5.

Table 22.5.3.5 Number of Sprinklers — Greater Than 12 ft (3.7 m) Separations

Steel		Copper	
2½ in.	15 sprinklers	2½ in.	20 sprinklers
3 in.	30 sprinklers	3 in.	35 sprinklers
3½ in.	60 sprinklers	3½ in.	65 sprinklers

For SI units, 1 in. = 25.4 mm.

Note: For other pipe and tube sizes, see Table 22.5.3.4.

22.5.3.6 Where sprinklers are installed above and below ceilings and such sprinklers are supplied from a common set of branch lines or separate branch lines supplied by a common cross main, such branch lines shall not exceed eight sprinklers above and eight sprinklers below any ceiling on either side of the cross main.

22.5.3.7 Pipe sizing up to and including 3 in. (76 mm) shall be as shown in Table 22.5.3.7 in accordance with Figure 22.5.2.3(a), Figure 22.5.2.3(b), and Figure 22.5.2.3(c) utilizing the greatest number of sprinklers to be found on any two adjacent levels.

Table 22.5.3.7 Number of Sprinklers Above and Below a Ceiling

Steel		Copper	
1 in.	2 sprinklers	1 in.	2 sprinklers
1¼ in.	4 sprinklers	1¼ in.	4 sprinklers
1½ in.	7 sprinklers	1½ in.	7 sprinklers
2 in.	15 sprinklers	2 in.	18 sprinklers
2½ in.	30 sprinklers	2½ in.	40 sprinklers
3 in.	60 sprinklers	3 in.	65 sprinklers

For SI units, 1 in. = 25.4 mm.

22.5.3.8 Branch lines and cross mains supplying sprinklers installed entirely above or entirely below ceilings shall be sized in accordance with Table 22.5.3.4 or Table 22.5.3.5.

22.5.3.9* Where the total number of sprinklers above and below a ceiling exceeds the number specified in Table 22.5.3.7 for 3 in. (76 mm) pipe, the pipe supplying such sprinklers shall be increased to 3½ in. (89 mm) and sized thereafter according to the schedule shown in Table 22.5.2.2.1 or Table 22.5.3.4 for the number of sprinklers above or below a ceiling, whichever is larger.

22.5.3.10 Where the distance between the sprinklers protecting the occupied area exceeds 12 ft (3.7 m) or the distance between the branch lines exceeds 12 ft (3.7 m), the branch lines shall be sized in accordance with either Table 22.5.3.5, taking into consideration the sprinklers protecting the occupied area only, or Table 22.5.3.7, whichever requires the greater size of pipe.

22.5.4* Extra Hazard Occupancies. Extra hazard occupancies shall be hydraulically calculated.

22.6 Deluge Systems.

Open sprinkler and deluge systems shall be hydraulically calculated according to applicable standards.

22.7* Exposure Protection Sprinkler Systems.

22.7.1 Exposure protection sprinkler systems shall be hydraulically calculated using Table 22.7.1 based on severity of exposure as indicated by a relative classification of guide number

or other approved source.

Table 22.7.1 Exposure Protection

Section A — Wall and Window Sprinklers						
Exposure Severity	Guide Number	Level of Wall or Window Sprinklers	Minimum Nominal K-factor	Discharge Coefficient (K-factor)	Minimum Average Application Rate over Protected Surface	
					gpm/ft²	mm/min
Light	1.50 or less	Top 2 levels	2.8 (40)	2.8 (40)	0.20	8.1
		Next lower 2 levels	1.9 (27)	1.9 (27)	0.15	6.1
		Next lower 2 levels	1.4 (20)	1.4 (20)	0.10	4.1
Moderate	1.5–2.20	Top 2 levels	5.6 (80)	5.6 (80)	0.30	12.2
		Next lower 2 levels	4.2 (60)	4.2 (60)	0.25	10.2
		Next lower 2 levels	2.8 (40)	2.8 (40)	0.20	8.1
Severe	>2.20	Top 2 levels	11.2 (161)	11.2 (161)	0.40	16.3
		Next lower 2 levels	8.0 (115)	8.0 (115)	0.35	14.3
		Next lower 2 levels	5.6 (80)	5.6 (80)	0.30	12.2

Section B — Cornice Sprinklers			
Guide Number	Cornice Sprinkler Minimal Nominal K-factor	Application Rate per Lineal Foot (gpm)	Application Rate per Lineal Meter (Lpm)
1.50 or less	2.8 (40)	0.75	9.3
>1.51–2.20	5.6 (80)	1.50	18.6
>2.20	11.2 (161)	3.00	37.2

For SI units, 1 in. = 25.4 mm; 1 gpm = 3.785 L/min; 1 gpm/ft² = 40.746 mm/min.

22.7.2 In no case shall compliance with Table 22.7.1 result in a sprinkler discharge pressure below 7 psi (0.49 bar).

22.7.3 Only half of the flow from upright, pendent, and other nondirectional sprinklers shall be used in determining the minimum average application rate over the protected surface.

22.7.4 The water supply shall be capable of simultaneously supplying the total demand of sprinklers along an exposure to a maximum length of 300 ft (91.4 m). Where systems of open sprinklers are used, the water supply shall be capable of simultaneously flowing all

sprinklers that would flow as part of all systems that could be actuated within any 300 ft (91.4 m) length.

22.7.5 The water supply duration for an exposure protection sprinkler system shall be a minimum of 60 minutes.

22.7.6 A level of window sprinklers as described in Table 22.7.1 shall be defined as a floor level of the building being protected.

22.7.7 Window sprinklers shall be permitted to cover more than 25 ft² (2.3 m²) of window area per level. However, the starting pressure shall be calculated based on the application rate over 25 ft² (2.3 m²) of window area as indicated in Table 22.7.1. The maximum spacing between window sprinklers shall not exceed 8 ft (2.44 m) unless listed for a greater distance.

22.8 In-Rack Sprinklers.

22.8.1 Pipes to in-rack sprinklers shall be sized by hydraulic calculations.

22.8.2 Water demand of sprinklers installed in racks shall be added to ceiling sprinkler water demand over the same protected area at the point of connection.

22.8.3 The demand shall be balanced to the higher pressure.

22.8.4 Water demand of sprinklers installed in racks or water curtains shall be added to the ceiling sprinkler water demand at the point of connection. Demands shall be balanced to the higher pressure. *(See Chapter 8.)*

22.9 Hose Allowance.

Water allowance for outside hose shall be added to the sprinkler and inside hose requirement at the connection to the city water main or a yard hydrant, whichever is closer to the system riser.

Chapter 23 Water Supplies

23.1 General.

23.1.1 Number of Supplies. Every automatic sprinkler system shall have at least one automatic water supply.

23.1.2 Capacity. Water supplies shall be capable of providing the required flow and pressure for the required duration as specified in Chapter 11, Chapter 12, and Chapter 21.

23.1.3 Size of Fire Mains.

23.1.3.1 No pipe smaller than 6 in. (150 mm) in diameter shall be installed as a private service main.

23.1.3.2* For mains that do not supply hydrants, sizes smaller than 6 in. (150 mm) shall be permitted to be used subject to the following restrictions:

(1) The main supplies only automatic sprinkler systems, open sprinkler systems, water

Copyright NFPA

spray fixed systems, foam systems, or Class II standpipe systems.

- (2) Hydraulic calculations show that the main will supply the total demand at the appropriate pressure. Systems that are not hydraulically calculated shall have a main at least as large as the system riser.

23.1.4 Underground Supply Pipe. For pipe schedule systems, the underground supply pipe shall be at least as large as the system riser.

23.1.5* Water Supply Treatment.

23.1.5.1 Water supplies and environmental conditions shall be evaluated for the existence of microbes and conditions that contribute to microbiologically influenced corrosion (MIC). Where conditions are found that contribute to MIC, the owner(s) shall notify the sprinkler system installer and a plan shall be developed to treat the system using one of the following methods:

- (1) Install a water pipe that will not be affected by the MIC microbes.
- (2) Treat all water that enters the system using an approved biocide.
- (3) Implement an approved plan for monitoring the interior conditions of the pipe at established time intervals and locations.

23.1.5.2 Water supplies and environmental conditions shall be evaluated for conditions that contribute to unusual corrosive properties. Where conditions are found that contribute to unusual corrosive properties, the owner(s) shall notify the sprinkler system installer and a plan shall be developed to treat the system using one of the following methods:

- (1) Install a water pipe that is corrosion resistant.
- (2) Treat all water that enters the system using an approved corrosion inhibitor.
- (3) Implement an approved plan for monitoring the interior conditions of the pipe at established intervals and locations.

23.1.5.3 Where approved biocides and corrosion inhibitors are used together they shall be compatible with each other and system components.

23.1.6 Arrangement.

23.1.6.1 Connection Between Underground and Aboveground Piping.

23.1.6.1.1 The connection between the system piping and underground piping shall be made with a suitable transition piece and shall be properly strapped or fastened by approved devices.

23.1.6.1.2 The transition piece shall be protected against possible damage from corrosive agents, solvent attack, or mechanical damage.

23.1.6.2* Connection Passing Through or Under Foundation Walls. When system piping pierces a foundation wall below grade or is located under the foundation wall, clearance shall be provided to prevent breakage of the piping due to building settlement.

23.1.7* Meters. Where meters are required by other authorities, they shall be listed.

23.1.8* Connection from Waterworks System.

23.1.8.1 Where connections are made from public waterworks systems, it might be necessary to guard against possible contamination of the public supply.

23.1.8.2 The requirements of the public health authority having jurisdiction shall be determined and followed.

23.1.8.3 Where equipment is installed to guard against possible contamination of the public water system, such equipment and devices shall be listed for fire protection service.

23.2 Types.

23.2.1* Connections to Waterworks Systems.

23.2.1.1 A connection to a reliable waterworks system shall be an acceptable water supply source.

23.2.1.2 The volume and pressure of a public water supply shall be determined from waterflow test data. An adjustment to the waterflow test data to account for daily and seasonal fluctuations, possible interruption by flood or ice conditions, large simultaneous industrial use, future demand on the water supply system, or any other condition that could affect the water supply shall be made as appropriate.

23.2.2* Pumps. A single automatically controlled fire pump installed in accordance with NFPA 20, *Standard for the Installation of Stationary Pumps for Fire Protection*, shall be an acceptable water supply source.

23.2.3 Pressure Tanks.

23.2.3.1 Acceptability.

23.2.3.1.1 A pressure tank installed in accordance with NFPA 22, *Standard for Water Tanks for Private Fire Protection*, shall be an acceptable water supply source.

23.2.3.1.2 Pressure tanks shall be provided with an approved means for automatically maintaining the required air pressure.

23.2.3.1.3 Where a pressure tank is the sole water supply, there shall also be provided an approved trouble alarm to indicate low air pressure and low water level with the alarm supplied from an electrical branch circuit independent of the air compressor.

23.2.3.1.4 Pressure tanks shall not be used to supply other than sprinklers and hand hose attached to sprinkler piping.

23.2.3.2 Capacity.

23.2.3.2.1 In addition to the requirements of 23.1.2, the water capacity of a pressure tank shall include the extra capacity needed to fill dry pipe or preaction systems where installed.

23.2.3.2.2 The total volume shall be based on the water capacity plus the air capacity required by 23.2.3.3.

23.2.3.3* Water Level and Air Pressure.

23.2.3.3.1 Pressure tanks shall be kept with a sufficient supply of water to meet the demand of the fire protection system as calculated in Chapter 22 for the duration required by Chapter 11, Chapter 12, or Chapter 21.

23.2.3.3.2 The pressure shall be sufficient to push all of the water out of the tank while maintaining the necessary residual pressure (required by Chapter 22) at the top of the system.

23.2.4 Gravity Tanks. An elevated tank installed in accordance with NFPA 22, *Standard for Water Tanks for Private Fire Protection*, shall be an acceptable water supply source.

23.2.5 Penstocks or Flumes, Rivers, or Lakes. Water supply connections from penstocks, flumes, rivers, lakes, or reservoirs shall be arranged to avoid mud and sediment and shall be provided with approved double removable screens or approved strainers installed in an approved manner.

Chapter 24 Systems Acceptance

24.1 Approval of Sprinkler Systems and Private Fire Service Mains.

The installing contractor shall do the following:

- (1) Notify the authority having jurisdiction and the property owner or the property owner's authorized representative of the time and date testing will be performed
- (2) Perform all required acceptance tests (*see Section 24.2*)
- (3) Complete and sign the appropriate contractor's material and test certificate(s) (*see Figure 24.1*)

Contractor's Material and Test Certificate for Aboveground Piping

PROCEDURE

Upon completion of work, inspection and tests shall be made by the contractor's representative and witnessed by the property owner or their authorized agent. All defects shall be corrected and system left in service before contractor's personnel finally leave the job.

A certificate shall be filled out and signed by both representatives. Copies shall be prepared for approving authorities, owners, and contractor. It is understood the owner's representative's signature in no way prejudices any claim against contractor for faulty material, poor workmanship, or failure to comply with approving authority's requirements or local ordinances.

Property name						Date		
Property address								
Plans	Accepted by approving authorities (names)							
	Address							
	Installation conforms to accepted plans					<input type="checkbox"/> Yes	<input type="checkbox"/> No	
	Equipment used is approved If no, explain deviations					<input type="checkbox"/> Yes	<input type="checkbox"/> No	
Instructions	Has person in charge of fire equipment been instructed as to location of control valves and care and maintenance of this new equipment? If no, explain					<input type="checkbox"/> Yes	<input type="checkbox"/> No	
	Have copies of the following been left on the premises?					<input type="checkbox"/> Yes	<input type="checkbox"/> No	
	1. System components instructions					<input type="checkbox"/> Yes	<input type="checkbox"/> No	
	2. Care and maintenance instructions					<input type="checkbox"/> Yes	<input type="checkbox"/> No	
3. NFPA 25					<input type="checkbox"/> Yes	<input type="checkbox"/> No		
Location of system	Supplies buildings							
Sprinklers	Make	Model	Year of manufacture	Orifice size	Quantity	Temperature rating		
Pipe and fittings	Type of pipe _____ Type of fittings _____							
Alarm valve or flow indicator	Alarm device			Maximum time to operate through test connection				
	Type	Make	Model	Minutes		Seconds		
Dry pipe operating test	Dry valve			Q. O. D.				
	Make	Model	Serial no.	Make	Model	Serial no.		
	Time to trip through test connection ^{a,b}		Water pressure	Air pressure	Trip point air pressure	Time water reached test outlet ^{a,b}		Alarm operated properly
			psi	psi	psi	Minutes	Seconds	Yes No
	Without Q.O.D.							
	With Q.O.D.							
If no, explain								

^a Measured from time inspector's test connection is opened
^b NFPA 13 only requires the 60-second limitation in specific sections

FIGURE 24.1 Contractor's Material and Test Certificate for Aboveground Piping.

Deluge and preaction valves	Operation <input type="checkbox"/> Pneumatic <input type="checkbox"/> Electric <input type="checkbox"/> Hydraulics							
	Piping supervised <input type="checkbox"/> Yes <input type="checkbox"/> No				Detecting media supervised <input type="checkbox"/> Yes <input type="checkbox"/> No			
	Does valve operate from the manual trip, remote, or both control stations? <input type="checkbox"/> Yes <input type="checkbox"/> No							
	Is there an accessible facility in each circuit for testing? <input type="checkbox"/> Yes <input type="checkbox"/> No						If no, explain	
	Make	Model	Does each circuit operate supervision loss alarm?		Does each circuit operate valve release?		Maximum time to operate release	
		Yes	No	Yes	No	Minutes	Seconds	
Pressure reducing valve test	Location and floor	Make and model	Setting	Static pressure		Residual pressure (flowing)		Flow rate
				Inlet (psi)	Outlet (psi)	Inlet (psi)	Outlet (psi)	Flow (gpm)
Test description	<p>Hydrostatic: Hydrostatic tests shall be made at not less than 200 psi (13.6 bar) for 2 hours or 50 psi (3.4 bar) above static pressure in excess of 150 psi (10.2 bar) for 2 hours. Differential dry-pipe valve clappers shall be left open during the test to prevent damage. All aboveground piping leakage shall be stopped.</p> <p>Pneumatic: Establish 40 psi (2.7 bar) air pressure and measure drop, which shall not exceed 1½ psi (0.1 bar) in 24 hours. Test pressure tanks at normal water level and air pressure and measure air pressure drop, which shall not exceed 1½ psi (0.1 bar) in 24 hours.</p>							
	All piping hydrostatically tested at _____ psi (____ bar) for _____ hours Dry piping pneumatically tested <input type="checkbox"/> Yes <input type="checkbox"/> No Equipment operates properly <input type="checkbox"/> Yes <input type="checkbox"/> No						If no, state reason	
Tests	Do you certify as the sprinkler contractor that additives and corrosive chemicals, sodium silicate or derivatives of sodium silicate, brine, or other corrosive chemicals were not used for testing systems or stopping leaks? <input type="checkbox"/> Yes <input type="checkbox"/> No							
	Drain test	Reading of gauge located near water supply test connection: _____ psi (____ bar)				Residual pressure with valve in test connection open wide: _____ psi (____ bar)		
	Underground mains and lead-in connections to system risers flushed before connection made to sprinkler piping							
	Verified by copy of the Contractor's Material and Test Certificate for Underground Piping. <input type="checkbox"/> Yes <input type="checkbox"/> No						Other Explain	
	Flushed by installer of underground sprinkler piping <input type="checkbox"/> Yes <input type="checkbox"/> No							
If powder-driven fasteners are used in concrete, has representative sample testing been satisfactorily completed? <input type="checkbox"/> Yes <input type="checkbox"/> No						If no, explain		
Blank testing gaskets	Number used		Locations				Number removed	
Welding	Welding piping <input type="checkbox"/> Yes <input type="checkbox"/> No							
	If yes . . .							
	Do you certify as the sprinkler contractor that welding procedures used complied with the minimum requirements of AWS B2.1, ASME Section IX <i>Welding and Brazing Qualifications</i> , or other applicable qualification standard as required by the AHJ?						<input type="checkbox"/> Yes <input type="checkbox"/> No	
	Do you certify that all welding was performed by welders or welding operators qualified in accordance with the minimum requirements of AWS B2.1, ASME Section IX <i>Welding and Brazing Qualifications</i> , or other applicable qualification standard as required by the AHJ?						<input type="checkbox"/> Yes <input type="checkbox"/> No	
Do you certify that the welding was conducted in compliance with a documented quality control procedure to ensure that (1) all discs are retrieved; (2) that openings in piping are smooth, that slag and other welding residue are removed; (3) the internal diameters of piping are not penetrated; (4) completed welds are free from cracks, incomplete fusion, surface porosity greater than 1/16 in. diameter, undercut deeper than the lesser of 25% of the wall thickness or 1/32 in.; and (5) completed circumferential butt weld reinforcement does not exceed 3/32 in.?						<input type="checkbox"/> Yes <input type="checkbox"/> No		

FIGURE 24.1 *Continued*

Cutouts (discs)	Do you certify that you have a control feature to ensure that all cutouts (discs) are retrieved? <input type="checkbox"/> Yes <input type="checkbox"/> No		
Hydraulic data nameplate	Nameplate provided <input type="checkbox"/> Yes <input type="checkbox"/> No	If no, explain	
Remarks	Date left in service with all control valves open		
Signatures	Name of sprinkler contractor		
	Tests witnessed by		
	The property owner or their authorized agent (signed)	Title	Date
	For sprinkler contractor (signed)	Title	Date
Additional explanations and notes			
<p>© 2006 National Fire Protection Association NFPA 13 (p. 3 of 3)</p>			

FIGURE 24.1 *Continued*

24.2 Acceptance Requirements.

24.2.1* Hydrostatic Tests.

24.2.1.1 Unless permitted by 24.2.1.2 through 24.2.1.6, all piping and attached appurtenances subjected to system working pressure shall be hydrostatically tested at 200 psi (13.8 bar) and shall maintain that pressure without loss for 2 hours.

24.2.1.2 Portions of systems normally subjected to system working pressures in excess of 150 psi (10.4 bar) shall be tested as described in 24.2.1.1, at a pressure of 50 psi (3.5 bar) in excess of system working pressure.

24.2.1.3 Where cold weather will not permit testing with water, an interim air test shall be permitted to be conducted as described in 24.2.2. This provision shall not remove or replace the requirement for conducting the hydrostatic test as described in 24.2.1.1.

24.2.1.4 Modifications affecting 20 or fewer sprinklers shall not require testing in excess of system working pressure.

24.2.1.5 Where addition or modification is made to an existing system affecting more than 20 sprinklers, the new portion shall be isolated and tested at not less than 200 psi (13.8 bar) for 2 hours.

24.2.1.6 Modifications that cannot be isolated, such as relocated drops, shall not require testing in excess of system working pressure.

24.2.1.7 Loss shall be determined by a drop in gauge pressure or visual leakage.

24.2.1.8 The test pressure shall be read from a gauge located at the low elevation point of the system or portion being tested.

24.2.1.9* Additives, corrosive chemicals such as sodium silicate, or derivatives of sodium silicate, brine, or similar acting chemicals shall not be used while hydrostatically testing systems or for stopping leaks.

24.2.1.10 Piping between the exterior fire department connection and the check valve in the fire department inlet pipe shall be hydrostatically tested in the same manner as the balance of the system. After repair or replacement work affecting the fire department connection, the piping between the exterior and the check valve in the fire department inlet pipe shall be isolated and hydrostatically tested at 150 psi (10.3 bar).

24.2.1.11 When deluge systems are being hydrostatically tested, plugs shall be installed in fittings and replaced with open sprinklers after the test is completed, or the operating elements of automatic sprinklers shall be removed after the test is completed.

24.2.1.12 Provision shall be made for the proper disposal of water used for flushing or testing.

24.2.1.13* Test Blanks.

24.2.1.13.1 Test blanks shall have painted lugs protruding in such a way as to clearly indicate their presence.

24.2.1.13.2 The test blanks shall be numbered, and the installing contractor shall have a record keeping method ensuring their removal after work is completed.

24.2.1.14 When subject to hydrostatic test pressures, the clapper of a differential-type valve shall be held off its seat to prevent damaging the valve.

24.2.2 Dry Pipe and Double Interlock Preaction System(s) Air Test.

24.2.2.1 In addition to the standard hydrostatic test, an air pressure leakage test at 40 psi (2.8 bar) shall be conducted for 24 hours. Any leakage that results in a loss of pressure in excess of 1½ psi (0.1 bar) for the 24 hours shall be corrected.

24.2.2.2 Where systems are installed in spaces that are capable of being operated at temperatures below 32°F (0°C), air pressure leakage tests required in 24.2.2 shall be conducted at the lowest nominal temperature of the space.

24.2.3 System Operational Tests.

24.2.3.1 Waterflow Devices. Waterflow detecting devices including the associated alarm circuits shall be flow tested through the inspector's test connection and shall result in an audible alarm on the premises within 5 minutes after such flow begins and until such flow stops.

24.2.3.2* Dry Pipe Systems.

24.2.3.2.1 A working test of the dry pipe valve alone and with a quick-opening device, if installed, shall be made by opening the inspector's test connection.

24.2.3.2.2* The test shall measure the time to trip the valve and the time for water to be discharged from the inspector's test connection. All times shall be measured from the time the inspector's test connection is completely opened.

24.2.3.2.2.1 Dry systems calculated for water delivery in accordance with 7.2.3.6 shall be exempt from any specific delivery time requirement.

24.2.3.2.3 The results shall be recorded using the contractor's material and test certificate for aboveground piping (*see Figure 24.1*).

24.2.3.3 Deluge and Preaction Systems.

24.2.3.3.1 The automatic operation of a deluge or preaction valve shall be tested in accordance with the manufacturer's instructions.

24.2.3.3.2 The manual and remote control operation, where present, shall also be tested.

24.2.3.4 Main Drain Valves.

24.2.3.4.1 The main drain valve shall be opened and remain open until the system pressure stabilizes.

24.2.3.4.2 The static and residual pressures shall be recorded on the contractor's material

and test certificate (*see Figure 24.1*).

24.2.3.5 Operating Test for Control Valves.

•
24.2.3.5.1 All control valves shall be fully closed and opened under system water pressure to ensure proper operation.

24.2.4 Pressure Reducing Valves.

24.2.4.1 Each pressure-reducing valve shall be tested upon completion of installation to ensure proper operation under flow and no-flow conditions.

24.2.4.2 Testing shall verify that the device properly regulates outlet pressure at both maximum and normal inlet pressure conditions.

24.2.4.3 The results of the flow test of each pressure-reducing valve shall be recorded on the contractor's material and test certificate (*see Figure 24.1*).

24.2.4.4 The results shall include the static and residual inlet pressures, static and residual outlet pressures, and the flow rate.

24.2.5 Backflow Prevention Assemblies.

24.2.5.1 The backflow prevention assembly shall be forward flow tested to ensure proper operation.

24.2.5.2 The minimum flow rate shall be the system demand, including hose stream allowance where applicable.

24.2.6 Exposure Systems. Operating tests shall be made of exposure protection systems upon completion of the installation, where such tests do not risk water damage to the building on which they are installed or to adjacent buildings.

24.3 Circulating Closed Loop Systems.

24.3.1 For sprinkler systems with non-fire protection connections, additional information shall be appended to the contractor's material and test certificate for aboveground piping shown in Figure 24.1 as follows:

- (1) Certification that all auxiliary devices, such as heat pumps, circulating pumps, heat exchangers, radiators, and luminaires, if a part of the system, have a pressure rating of at least 175 psi or 300 psi (12.1 bar or 20.7 bar) if exposed to pressures greater than 175 psi (12.1 bar).
- (2) All components of sprinkler system and auxiliary system have been pressure tested as a composite system in accordance with 24.2.2.
- (3) Waterflow tests have been conducted and waterflow alarms have operated while auxiliary equipment is in each of the possible modes of operation.
- (4) With auxiliary equipment tested in each possible mode of operation and with no flow from sprinklers or test connection, waterflow alarm signals did not operate.

- (5) Excess temperature controls for shutting down the auxiliary system have been properly field tested.

24.3.2 Discharge tests of sprinkler systems with non–fire protection connections shall be conducted using system test connections described in 6.9.1.

24.3.3 Pressure gauges shall be installed at critical points and readings shall be taken under various modes of auxiliary equipment operation.

24.3.4 Waterflow alarm signals shall be responsive to discharge of water through system test pipes while auxiliary equipment is in each of the possible modes of operation.

24.4 Instructions.

The installing contractor shall provide the property owner or the property owner's authorized representative with the following:

- (1) All literature and instructions provided by the manufacturer describing proper operation and maintenance of any equipment and devices installed
- (2) NFPA 25, *Standard for the Inspection, Testing, and Maintenance of Water-Based Fire Protection Systems*

24.5* Hydraulic Design Information Sign.

24.5.1 The installing contractor shall identify a hydraulically designed sprinkler system with a permanently marked weatherproof metal or rigid plastic sign secured with corrosion-resistant wire, chain, or other approved means. Such signs shall be placed at the alarm valve, dry pipe valve, preaction valve, or deluge valve supplying the corresponding hydraulically designed area.

24.5.2 The sign shall include the following information:

- (1) Location of the design area or areas
- (2) Discharge densities over the design area or areas
- (3) Required flow and residual pressure demand at the base of the riser
- (4) Occupancy classification or commodity classification and maximum permitted storage height and configuration
- (5) Hose stream allowance included in addition to the sprinkler demand
- (6) The name of the installing contractor

24.6* General Information Sign.

24.6.1 The installing contractor shall provide a general information sign used to determine system design basis and information relevant to the inspection, testing, and maintenance requirements required by NFPA 25, *Standard for the Inspection, Testing, and Maintenance of Water-Based Fire Protection Systems*. Such general information shall be provided with a permanently marked weatherproof metal or rigid plastic sign, secured with

corrosion-resistant wire, chain, or other acceptable means. Such signs shall be placed at each system control riser, antifreeze loop, and auxiliary system control valve.

24.6.2 The sign shall include the following information:

- (1) Name and location of the facility protected
- (2) Presence of high-piled and/or rack storage
- (3) Maximum height of storage planned
- (4) Aisle width planned
- (5) Commodity classification
- (6) Encapsulation of pallet loads
- (7) Presence of solid shelving
- (8) Flow test data
- (9) Presence of flammable/combustible liquids
- (10) Presence of hazardous materials
- (11) Presence of other special storage
- (12) Location of auxiliary drains and low point drains
- (13) Original results of main drain flow test
- (14) Name of installing contractor or designer
- (15) Indication of presence and location of antifreeze or other auxiliary systems

Chapter 25 Marine Systems

25.1 General.

25.1.1 Chapter 25 outlines the deletions, modifications, and additions that shall be required for marine application. The applicability of Chapter 25 shall be determined by the authority having jurisdiction.

25.1.2 All other requirements of this standard shall apply to merchant vessel systems except as modified by this chapter.

25.1.3 The following definitions shall be applicable to this chapter (*see Section 3.16*):

- (1) *A-Class Boundary* — A boundary designed to resist the passage of smoke and flame for 1 hour when tested in accordance with ASTM E 119, *Standard Test Methods for Fire Tests of Building Construction and Materials*.
- (2) *B-Class Boundary* — A boundary designed to resist the passage of flame for ½ hour when tested in accordance with ASTM E 119.
- (3) *Central Safety Station* — A continuously manned control station from which all of

the fire control equipment is monitored. If this station is not the bridge, direct communication with the bridge shall be provided by means other than the ship's service telephone.

- (4)* *Heat-Sensitive Material* — A material whose melting point is below 1700°F (926.7°C).
- (5) *Heel* — The inclination of a ship to one side.
- (6) *Heel Angle* — The angle defined by the intersection of a vertical line through the center of a vessel and a line perpendicular to the surface of the water.
- (7) *International Shore Connection* — A universal connection to the vessel's fire main to which a shoreside fire-fighting water supply can be connected.
- (8)* *Marine System* — A sprinkler system installed on a ship, boat, or other floating structure that takes its supply from the water on which the vessel floats.
- (9)* *Marine Thermal Barrier* — An assembly that is constructed of noncombustible materials and made intact with the main structure of the vessel, such as shell, structural bulkheads, and decks. A marine thermal barrier shall meet the requirements of a B-Class boundary. In addition, a marine thermal barrier shall be insulated such that, if tested in accordance with ASTM 119 for 15 minutes, the average temperature of the unexposed side does not rise more than 250°F (121°C) above the original temperature, nor does the temperature at any one point, including any joint, rise more than 405°F (207°C) above the original temperature.
- (10) *Supervision* — A visual and audible alarm signal given at the central safety station to indicate when the system is in operation or when a condition that would impair the satisfactory operation of the system exists. Supervisory alarms shall give a distinct indication for each individual system component that is monitored.
- (11) *Survival Angle* — The maximum angle to which a vessel is permitted to heel after the assumed damage required by stability regulations is imposed.
- (12) *Type 1 Stair* — A fully enclosed stair that serves all levels of a vessel in which persons can be employed.
- (13) *Marine Water Supply* — The supply portion of the sprinkler system from the water pressure tank or the sea suction of the designated sprinkler system pump up to and including the valve that isolates the sprinkler system from these two water sources.

25.1.4* Occupancy Classifications. Marine environment classifications shall be in accordance with Section 5.1.

25.1.5* Partial Installations.

25.1.5.1 Partial installation of automatic sprinklers shall not be permitted, unless the requirements of 25.1.5.2 or 25.1.5.3 are met.

25.1.5.2 Spaces shall be permitted to be protected with an alternative, approved fire suppression system where such areas are separated from the sprinklered areas with a 1

hour-rated assembly.

25.1.5.3 The requirements of 25.1.5.1 shall not apply where specific sections of this standard permit the omission of sprinklers.

25.2 System Components, Hardware, and Use.

25.2.1* Sprinklers shall have a K-factor of K-2.8 (40) or greater.

25.2.2* Sprinkler piping penetrations shall be designed to preserve the fire integrity of the ceiling or bulkhead penetrated.

25.2.3 Spare Sprinklers.

25.2.3.1 The required stock of spare sprinklers shall be carried for each type of sprinkler installed onboard the vessel.

25.2.3.2 Where fewer than six sprinklers of a particular type are installed, 100 percent spares shall be kept in stock.

25.2.3.3 Where applicable, at least one elastometric gasket shall be kept in the cabinet for each fire department connection that is installed onboard the vessel.

25.2.3.4 The cabinet containing spare sprinklers, special wrenches, and elastometric gaskets shall be located in the same central safety station that contains the alarm annunciator panel(s) and supervisory indicators.

25.2.4 System Pipe and Fittings.

25.2.4.1* When ferrous materials are used for piping between the sea chest and zone control valves, these materials shall be protected against corrosion by hot dip galvanizing or by the use of Schedule 80 piping.

25.2.4.2 Maximum design pressure for copper and brass pipe shall not exceed 250 psi (17.2 bar).

25.2.5 Pipe Support.

25.2.5.1* Pipe supports shall comply with the following:

- (1) Pipe supports shall be designed to provide adequate lateral, longitudinal, and vertical sway bracing.
- (2) The design shall account for the degree of bracing, which varies with the route and operation of the vessel.
- (3) Bracing shall be designed to ensure the following:
 - (a) Slamming, heaving, and rolling will not shift sprinkler piping, potentially moving sprinklers above ceilings, bulkheads, or other obstructions.
 - (b) Piping and sprinklers will remain in place at a steady heel angle at least equal to the maximum required damaged survival angle.
- (4) Pipe supports shall be welded to the structure.

- (5) Hangers that can loosen during ship motion or vibration, such as screw-down-type hangers, shall not be permitted.
- (6) Hangers that are listed for seismic use shall be permitted to be used in accordance with their listing.

25.2.5.2 Sprinkler piping shall be supported by the primary structural members of the vessel such as beams, girders, and stiffeners.

25.2.5.3* The components of hanger assemblies that are welded directly to the ship structure shall not be required to be listed.

25.2.5.4* U-hook sizes shall be no less than that specified in Table 9.1.2.4.

25.2.6 Valves.

25.2.6.1* All indicating, supply, and zone control valves shall be supervised open from a central safety station.

25.2.6.2 Drain and test valves shall meet the applicable requirements of 46 CFR 56.20 and 56.60.

25.2.6.3 Valve markings shall include the information required by 46 CFR 56.20-5(a).

25.2.7 Fire Department Connections and International Shore Connections.

25.2.7.1* A fire department connection and an International Shore Connection shall be installed.

25.2.7.2 The requirements for a fire department connection in 25.2.7.1 shall not apply to vessels that operate primarily on international voyages.

25.2.7.3 Connections shall be located near the gangway or other shore access point so that they are readily accessible to the land-based fire department.

25.2.7.4 Fire department and International Shore Connections shall be colored and marked so that the connections are easily located from the shore access point (i.e., gangway location) and will not be confused with a firemain connection.

25.2.7.5 An 18 in. × 18 in. (0.46 m × 0.46 m) sign displaying the symbol for fire department connection as shown in Table 5.2.1 of NFPA 170, *Standard for Fire Safety and Emergency Symbols*, shall be placed at the connection so that it is in plain sight from the shore access point.

25.2.7.6 Connections on both sides of the vessel shall be provided where shore access arrangements make it necessary.

25.2.7.7* Fire department connection thread type shall be compatible with fire department equipment.

25.2.7.8 International shore connections shall comply with ASTM F 1121, *Standard Specification for International Shore Connections for Marine Fire Applications*.

25.3 System Requirements.

Copyright NFPA

25.3.1* Relief Valves. Relief valves shall be provided on all wet pipe systems.

25.3.2 Spare Detection Devices. The number of spare detection devices or fusible elements used for protection systems that shall be carried per temperature rating is as follows:

- (1) Vessels shall have two spare detection devices or fusible elements when operating voyages are normally less than 24 hours.
- (2) Vessels shall have four spare detection devices or fusible elements when operating voyages are normally more than 24 hours.

25.3.3 System Piping Supervision. All preaction sprinkler systems shall be supervised regardless of the number of sprinklers supplied.

25.3.4 Circulating Closed Loop Systems. Circulating closed loop systems shall not be permitted.

25.4 Installation Requirements.

25.4.1 Temperature Zones. Intermediate temperature-rated sprinklers shall be installed under a noninsulated steel deck that is exposed to sunlight.

25.4.2* Residential Sprinklers. Residential sprinklers shall be permitted for use only in sleeping accommodation areas.

25.4.3 Window Protection. Where required, windows shall be protected by sprinklers installed at a distance not exceeding 1 ft (0.3 m) from the glazing at a spacing not exceeding 6 ft (1.8 m) such that the entire glazing surface is wetted at a linear density not less than 6 gpm/ft (75 mm/min), unless listed window sprinkler protection systems are installed in accordance with their installation and testing criteria.

25.4.4* Concealed Spaces.

25.4.4.1 Concealed spaces that are constructed of combustible materials, or materials with combustible finishes or that contain combustible materials, shall be sprinklered.

25.4.4.2 The requirements of 25.4.4.1 shall not apply to concealed spaces that contain only nonmetallic piping that is continuously filled with water.

25.4.5 Vertical Shafts.

25.4.5.1 Sprinklers are not required in vertical shafts used as duct, electrical, or pipe shafts that are nonaccessible, noncombustible, and enclosed in an A-Class-rated assembly.

25.4.5.2 Stairway enclosures shall be fully sprinklered.

25.4.6 Bath Modules. Sprinklers shall be installed in bath modules (full room modules) constructed with combustible materials, regardless of room fire load.

25.4.7 Ceiling Types. Drop-out ceilings shall not be used in conjunction with sprinklers.

25.4.8 Return Bends.

25.4.8.1 To prevent sediment buildup, return bends shall be installed in all shipboard

sprinkler systems where pendent-type or dry pendent-type sprinklers are used in wet systems (see Figure 8.15.18.2).

25.4.8.2 Consideration shall be given concerning the intrusion of saltwater into the system.

25.4.8.3 Specifically, sprinklers shall not be rendered ineffective by corrosion related to saltwater entrapment within the return bend.

25.4.9 Hose Connections. Sprinkler system piping shall not be used to supply hose connections or hose connections for fire department use.

25.4.10 Heat-Sensitive Piping Materials.

25.4.10.1 Portions of the piping system constructed with a heat-sensitive material shall be subject to the following restrictions:

- (1) Piping shall be of non-heat-sensitive type from the sea suction up through the penetration of the last A-Class barrier enclosing the space(s) in which the heat-sensitive piping is installed.
- (2) B-Class draft stops shall be fitted not more than 45 ft (13.7 m) apart between the marine thermal barrier (see definitions in Chapter 3 and 25.1.3) and the deck or shell.
- (3) Portions of a system that are constructed from heat-sensitive materials shall be installed behind a marine thermal barrier, unless the provisions of item (4) are met.
- (4)* Piping materials with brazed joints shall not be required to be installed behind a marine thermal barrier, provided the following conditions are met:
 - (a) The system is of the wet pipe type.
 - (b) The piping is not located in spaces containing boilers, internal combustion engines, or piping containing flammable or combustible liquids or gases under pressure, cargo holds, or vehicle decks.
 - (c) A relief valve in compliance with 7.1.2 is installed in each section of piping that is capable of being isolated by a valve(s).
 - (d) A valve(s) isolating the section of piping from the remainder of the system is installed in accordance with 25.4.10.2 and 25.4.10.3.

25.4.10.2 Each zone in which heat-sensitive piping is installed shall be fitted with a valve capable of segregating that zone from the remainder of the system.

25.4.10.3 The valve shall be supervised and located outside of the zone controlled and within a readily accessible compartment having A-Class boundaries or within a Type 1 stair.

25.4.11 Discharge of Drain Lines.

25.4.11.1 Drain lines shall not be connected to housekeeping, sewage, or deck drains. Drains shall be permitted to be discharged to bilges.

25.4.11.2 Overboard discharges shall meet the requirements of 46 CFR 56.50-95 and shall

be corrosion resistant in accordance with 46 CFR 56.60.

25.4.11.3 Systems that contain water additives that are not permitted to be discharged into the environment shall be specially designed to prevent such discharge.

25.4.11.4 Discharges shall be provided with a down-turned elbow.

25.4.12 Alarm Signals and Devices.

25.4.12.1* A visual and audible alarm signal shall be given at the central safety station to indicate when the system is in operation or when a condition that would impair the satisfactory operation of the system exists.

25.4.12.2 Alarm signals shall be provided for, but not limited to, each of the following: monitoring position of control valves, fire pump power supplies and operating condition, water tank levels and temperatures, zone waterflow alarms, pressure of tanks, and air pressure on dry pipe valves.

25.4.12.3 Alarms shall give a distinct indication for each individual system component that is monitored.

25.4.12.4 An audible alarm shall be given at the central safety station within 30 seconds of waterflow.

25.4.12.5 Waterflow alarms shall be installed for every zone of the sprinkler system.

25.4.12.6 Sprinkler zones shall not encompass more than two adjacent decks or encompass more than one main vertical zone.

25.4.12.7 Electrically operated alarm attachments shall comply with, meet, and be installed in accordance with the requirements of 46 CFR, Subchapter J, "Electrical Engineering."

25.4.12.8 All wiring shall be chosen and installed in accordance with IEEE 45, *Recommended Practice for Electrical Installations on Shipboard*.

25.4.13 Test Connections. Where test connections are below the bulkhead deck, they shall comply with the overboard discharge arrangements of 46 CFR 56.50-95.

25.4.14 Protection of Copper Tubing. Copper tubing materials shall be protected against physical damage in areas where vehicles and stores handling equipment operate.

25.5 Design Approaches.

25.5.1 Design Options.

25.5.1.1 Marine sprinkler systems shall be designed using the hydraulic calculation procedure of Chapter 22.

25.5.1.2 The pipe schedule method shall not be used to determine the water demand requirements.

25.5.2* Window Protection. Minimum water demand requirements shall include sprinklers that are installed for the protection of windows as described in 25.4.3.

25.5.3* Hose Stream Allowance. No allowance for hose stream use shall be required.

25.6 Plans and Calculations.

25.6.1 Additional Information. The pressure tank size, high-pressure relief setting, high and low water alarm settings, low-pressure alarm setting, and pump start pressure shall be provided.

25.6.2 Sprinklers specifically installed for the protection of windows under 25.4.3 shall be permitted to be of a different size from those protecting the remainder of the occupancy classification.

25.6.3 All of the window sprinklers, however, shall be of the same size.

25.6.4* Marine sprinkler systems shall be designed and installed to be fully operational without a reduction in system performance when the vessel is upright and inclined at the angles of inclination specified in 46 CFR 58.01-40.

25.7 Water Supplies.

25.7.1 General. The water supply requirements for marine applications shall be in accordance with Section 25.7.

25.7.2 Pressure Tank.

25.7.2.1 Unless the requirements of 25.7.2.2 are met, a pressure tank shall be provided. The pressure tank shall be sized and constructed so that the following occurs:

- (1) The tank shall contain a standing charge of freshwater equal to that specified by Table 25.7.2.1.
- (2) The pressure tank shall be sized in accordance with 23.2.3.
- (3) A glass gauge shall be provided to indicate the correct level of water within the pressure tank.
- (4) Arrangements shall be provided for maintaining an air pressure in the tank such that, while the standing charge of water is being expended, the pressure will not be less than that necessary to provide the design pressure and flow of the hydraulically most remote design area.
- (5) Suitable means of replenishing the air under pressure and the fresh water standing charge in the tank shall be provided.
- (6) Tank construction shall be in accordance with the applicable requirements of 46 CFR, Subchapter F, "Marine Engineering."

Table 25.7.2.1 Required Water Supply

System Type	Additional Water Volume
Wet pipe system	Flow requirement of the hydraulically most remote system demand for 1 minute

Table 25.7.2.1 Required Water Supply

System Type	Additional Water Volume
Preaction system	Flow requirement of the
Deluge system	hydraulically most remote system
Dry pipe system	demand for 1 minute of system demand plus the volume needed to fill all dry piping

25.7.2.2 Pressure Tank Alternative. In lieu of a pressure tank, a dedicated pump connected to a freshwater tank shall be permitted to be used, provided the following conditions are met:

- (1) The pump is listed for marine use and is sized to meet the required system demand.
- (2) The suction for the fire pump is located below the suction for the freshwater system so that there shall be a minimum water supply of at least 1 minute for the required system demand.
- (3) Pressure switches are provided in the system and the controller for the pump that automatically start the pump within 10 seconds after detection of a pressure drop of more than 5 percent.
- (4) There shall be a reduced pressure zone backflow preventer to prevent contamination of the potable water system by saltwater.
- (5) There are at least two sources of power for this pump. Where the sources of power are electrical, these shall be a main generator and an emergency source of power. One supply shall be taken from the main switchboard, by separate feeder reserved solely for that purpose. This feeder shall be run to an automatic changeover switch situated near the sprinkler unit, and the switch shall normally be kept closed to the feeder from the emergency switchboard. The changeover switch shall be clearly labeled, and no other switch shall be permitted in these feeders.

25.7.2.3 Relief Valves.

25.7.2.3.1 Relief valves shall be installed on the tank to avoid overpressurization and false actuation of any dry pipe valve.

25.7.2.3.2 Relief valves shall comply with 46 CFR 54.15-10.

25.7.2.4 Power Source.

25.7.2.4.1 There shall be not less than two sources of power for the compressors that supply air to the pressure tank.

25.7.2.4.2 Where the sources of power are electrical, these shall be a main generator and an emergency source of power.

25.7.2.4.3 One supply shall be taken from the main switchboard, by separate feeders reserved solely for that purpose.

25.7.2.4.4 Such feeders shall be run to a changeover switch situated near the air compressor, and the switch normally shall be kept closed to the feeder from the emergency switchboard.

25.7.2.4.5 The changeover switch shall be clearly labeled, and no other switch shall be permitted in these feeders.

25.7.2.5 Multiple Tanks.

25.7.2.5.1 More than one pressure tank can be installed, provided that each is treated as a single water source when determining valve arrangements.

25.7.2.5.2 Check valves shall be installed to prohibit flow from tank to tank or from pump to tank, unless the tank is designed to hold only pressurized air.

25.7.2.6 In systems subject to use with saltwater, valves shall be so arranged as to prohibit contamination of the pressure tank with saltwater.

25.7.2.7* Where applicable, a means shall be provided to restrict the amount of air that can enter the pressure tank from the air supply system. A means shall also be provided to prevent water from backflowing into the air supply system.

25.7.3 Fire Pump.

25.7.3.1 A dedicated, automatically controlled pump that is listed for marine service, which takes suction from the sea, shall be provided to supply the sprinkler system.

25.7.3.2 Where two pumps are required to ensure the reliability of the water supply, the pump that supplies the fire main shall be allowed to serve as the second fire pump.

25.7.3.3* The pump shall be sized to meet the water demand of the hydraulically most demanding area.

25.7.3.4 Pumps shall be designed to not exceed 120 percent of the rated capacity of the pump.

25.7.3.5 The system shall be designed so that, before the supply falls below the design criteria, the fire pump shall be automatically started and shall supply water to the system until manually shut off.

25.7.3.6 Where pump and freshwater tank arrangement is used in lieu of the pressure tank, there must be a pressure switch that senses a system pressure drop of 25 percent, and the controller must automatically start the fire pump(s) if pressure is not restored within 20 seconds.

25.7.3.7 There shall be not less than two sources of power supply for the fire pumps. Where the sources of power are electrical, these shall be a main generator and an emergency source of power.

25.7.3.8 One supply shall be taken from the main switchboard by separate feeders reserved solely for that purpose.

25.7.3.9 Such feeders shall be run to a changeover switch situated near to the sprinkler unit,

and the switch normally shall be kept closed to the feeder from the emergency switchboard.

25.7.3.10 The changeover switch shall be clearly labeled, and no other switch shall be permitted in these feeders.

25.7.3.11 Test Valves.

25.7.3.11.1 A test valve(s) shall be installed on the discharge side of the pump with a short open-ended discharge pipe.

25.7.3.11.2 The area of the pipe shall be adequate to permit the release of the required water output to supply the demand of the hydraulically most remote area.

25.7.3.12 Multiple Pumps.

25.7.3.12.1 Where two fire pumps are required to ensure the reliability of the water supply, each fire pump shall meet the requirements of 25.7.3.1 through 25.7.3.4.

25.7.3.12.2 In addition, a system that is required to have more than one pump shall be designed to accommodate the following features:

- (1)* Pump controls and system sensors shall be arranged such that the secondary pump will automatically operate if the primary pump fails to operate or deliver the required water pressure and flow. *[Figure A.25.7.3.12.2(1) is an example of an acceptable dual pump arrangement.]*
- (2) Both pumps shall be served from normal and emergency power sources. However, where approved by the authority having jurisdiction, the secondary pump shall be permitted to be nonelectrically driven.
- (3) Pump failure or operation shall be indicated at the central safety station.

25.7.3.13* If not specifically prohibited, the fire pump that supplies the fire main shall be permitted to be used as the second pump, provided the following conditions are met:

- (1) The pump is adequately sized to meet the required fire hose and sprinkler system pressure and flow demands simultaneously.
- (2) The fire main system is segregated from the sprinkler system by a normally closed valve that is designed to automatically open upon failure of the designated fire pump.
- (3) The fire pump that supplies the fire main is automatically started in the event of dedicated fire pump failure or loss of pressure in the sprinkler main. *(See Figure A.25.7.3.13.)*

25.7.4 Water Supply Configurations.

25.7.4.1 The pressure tank and fire pump shall be located in a position reasonably remote from any machinery space of Category A.

25.7.4.2 All valves within the water supply piping system shall be supervised.

25.7.4.3 Only freshwater shall be used as the initial charge within the piping network.

25.7.4.4 The sprinkler system shall be cross-connected with the ship's fire main system and

fitted with a lockable screw-down nonreturn valve such that backflow from the sprinkler system to the fire main is prevented.

25.7.4.5 The piping, tanks, and pumps that make up the water supply shall be installed in accordance with the applicable requirements of 46 CFR, Subchapter F, “Marine Engineering.”

25.7.4.6* When a shore water supply is to be used during extended dockside periods, the water supply shall be qualified in the manner described in 23.2.1.

25.7.4.7 Tests shall be conducted in accordance with the requirements of the local shore-based authority having jurisdiction.

25.7.4.8 The water supply information listed in Section 11.3 shall then be provided to the authority having jurisdiction.

25.8 System Acceptance.

25.8.1 Hydrostatic Tests. In addition to the interior piping, the test required by 24.2.1.10 shall also be conducted on all external water supply connections including international shore and fireboat connections.

25.8.2 Alarm Test. A waterflow test shall result in an alarm at the central safety station within 30 seconds after flow through the test connection begins.

25.8.3 Operational Tests.

25.8.3.1 Pressure tank and pump operation, valve actuation, and waterflow shall also be tested.

25.8.3.2 Pump operation and performance shall be tested in accordance with Chapter 14 of NFPA 20, *Standard for the Installation of Stationary Pumps for Fire Protection*.

25.9 System Instructions and Maintenance.

25.9.1 Instructions for operation, inspection, maintenance, and testing shall be kept on the vessel.

25.9.2 Records of inspections, tests, and maintenance required by NFPA 25, *Standard for the Inspection, Testing, and Maintenance of Water-Based Fire Protection Systems*, shall also be kept on the vessel.

Chapter 26 System Inspection, Testing, and Maintenance

26.1* General.

A sprinkler system installed in accordance with this standard shall be properly inspected, tested, and maintained by the property owner or their authorized representative in accordance with NFPA 25, *Standard for the Inspection, Testing, and Maintenance of Water-Based Fire Protection Systems*, to provide at least the same level of performance and

protection as designed.

Annex A Explanatory Material

Annex A is not a part of the requirements of this NFPA document but is included for informational purposes only. This annex contains explanatory material, numbered to correspond with the applicable text paragraphs.

A.1.1 This standard provides a range of sprinkler system approaches, design development alternatives, and component options that are all acceptable. Building owners and their designated representatives are advised to carefully evaluate proposed selections for appropriateness and preference.

A.1.2 Since its inception, this document has been developed on the basis of standardized materials, devices, and design practices. However, Section 1.2 and other subsections such as 6.3.6 and 8.4.8 allow the use of materials and devices not specifically designated by this standard, provided such use is within parameters established by a listing organization. In using such materials or devices, it is important that all conditions, requirements, and limitations of the listing be fully understood and accepted and that the installation be in complete accord with such listing requirements.

A.3.2.1 Approved. The National Fire Protection Association does not approve, inspect, or certify any installations, procedures, equipment, or materials; nor does it approve or evaluate testing laboratories. In determining the acceptability of installations, procedures, equipment, or materials, the authority having jurisdiction may base acceptance on compliance with NFPA or other appropriate standards. In the absence of such standards, said authority may require evidence of proper installation, procedure, or use. The authority having jurisdiction may also refer to the listings or labeling practices of an organization that is concerned with product evaluations and is thus in a position to determine compliance with appropriate standards for the current production of listed items.

A.3.2.2 Authority Having Jurisdiction (AHJ). The phrase “authority having jurisdiction,” or its acronym AHJ, is used in NFPA documents in a broad manner, since jurisdictions and approval agencies vary, as do their responsibilities. Where public safety is primary, the authority having jurisdiction may be a federal, state, local, or other regional department or individual such as a fire chief; fire marshal; chief of a fire prevention bureau, labor department, or health department; building official; electrical inspector; or others having statutory authority. For insurance purposes, an insurance inspection department, rating bureau, or other insurance company representative may be the authority having jurisdiction. In many circumstances, the property owner or his or her designated agent assumes the role of the authority having jurisdiction; at government installations, the commanding officer or departmental official may be the authority having jurisdiction.

A.3.2.3 Listed. The means for identifying listed equipment may vary for each organization concerned with product evaluation; some organizations do not recognize equipment as listed unless it is also labeled. The authority having jurisdiction should utilize the system employed by the listing organization to identify a listed product.

A.3.3.2 Bathroom. A room is still considered a bathroom if it contains just a toilet. Additionally, two bathrooms can be adjacent to each other and are considered separate rooms, provided they are enclosed with the required level of construction.

A.3.3.16 Sprinkler System. A sprinkler system is considered to have a single system riser control valve. The design and installation of water supply facilities such as gravity tanks, fire pumps, reservoirs, or pressure tanks are covered by NFPA 20, *Standard for the Installation of Stationary Pumps for Fire Protection*, and NFPA 22, *Standard for Water Tanks for Private Fire Protection*.

A.3.4.6 Gridded Sprinkler System. See Figure A.3.4.6.

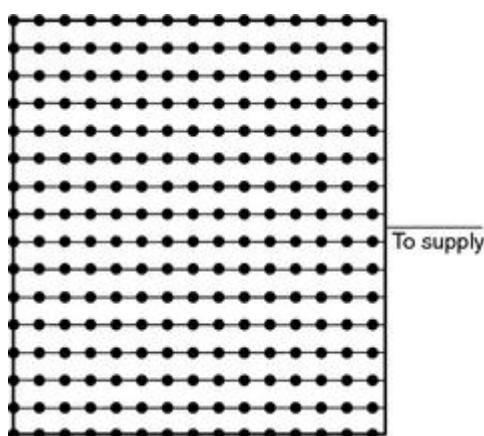

FIGURE A.3.4.6 Gridded System.

A.3.4.7 Looped Sprinkler System. See Figure A.3.4.7.

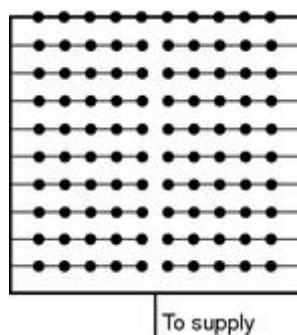

FIGURE A.3.4.7 Looped System.

A.3.4.9 Preaction Sprinkler System. The actuating means of the valve are described in 7.3.2.1. Actuation of the detection system and sprinklers in the case of double-interlocked systems opens a valve that permits water to flow into the sprinkler piping system and to be discharged from any sprinklers that are open.

A.3.5 See Figure A.3.5.

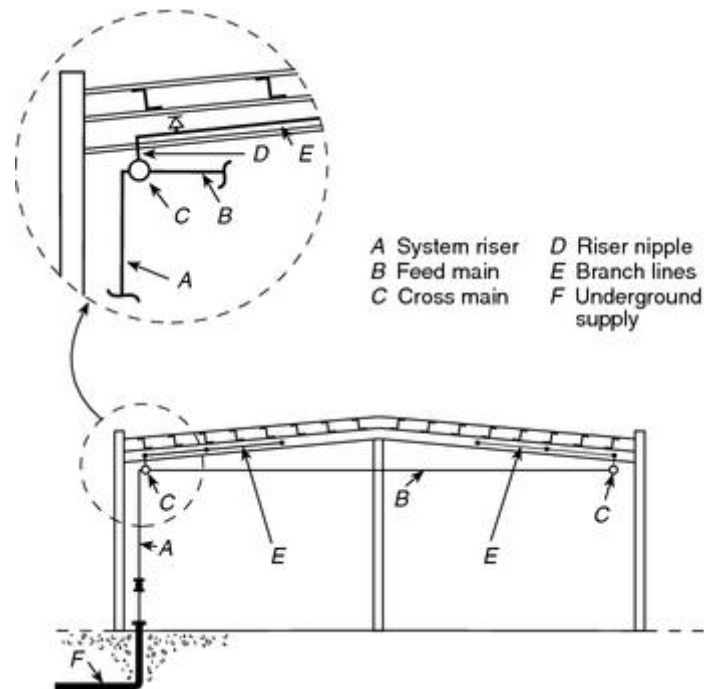

FIGURE A.3.5 Building Elevation Showing Parts of Sprinkler Piping System.

A.3.6.1 Sprinkler Characteristics, General. The response time index (RTI) is a measure of the sensitivity of the sprinkler's thermal element as installed in a specific sprinkler. It is usually determined by plunging a sprinkler into a heated laminar airflow within a test oven. The plunge test is not currently applicable to certain sprinklers.

The RTI is calculated using the following:

- (1) The operating time of the sprinkler
- (2) The operating temperature of the sprinkler's heat-responsive element (as determined in a bath test)
- (3) The air temperature of the test oven
- (4) The air velocity of the test oven
- (5) The sprinkler's conductivity (*c*) factor, which is the measure of conductance between the sprinkler's heat-responsive element and the sprinkler oven mount

Other factors affecting response include the temperature rating, sprinkler position, fire exposure, and radiation.

ISO Standard 6182-1 currently recognizes the RTI range of greater than 50 (meters-seconds)^{1/2} and less than 80 (meters-seconds)^{1/2} as special response. Such sprinklers can be recognized as special sprinklers under 8.4.8.1.

It should be recognized that the term *fast response* (like the term *quick response* used to define a particular type of sprinkler) refers to the thermal sensitivity within the operating element of a sprinkler, not the time of operation in a particular installation. There are many other factors, such as ceiling height, spacing, ambient room temperature, and distance below

ceiling, that affect the time of response of sprinklers. In most fire scenarios, sprinkler activation times will be shortest where the thermal elements are located 1 in. (25.4 mm) to 3 in. (76.2 mm) below the ceiling. A fast-response sprinkler is expected to operate quicker than a standard-response sprinkler in the same installation orientation. For modeling purposes, concealed sprinklers can be considered equivalent to pendent sprinklers having a similar thermal response sensitivity installed 12 in. (305 mm) below smooth unobstructed ceilings, and recessed sprinklers can be considered equivalent to pendent sprinklers having a similar thermal response sensitivity installed 8 in. (203 mm) below smooth unobstructed ceilings.

A.3.6.2.1 Early Suppression Fast-Response (ESFR) Sprinkler. It is important to realize that the effectiveness of these highly tested and engineered sprinklers depends on the combination of fast response and the quality and uniformity of the sprinkler discharge. It should also be realized that ESFR sprinklers cannot be relied upon to provide fire control, let alone suppression, if they are used outside the guidelines specified in Chapter 12.

A.3.6.2.7 Quick-Response Early Suppression (QRES) Sprinkler. Research into the development of QRES sprinklers is continuing under the auspices of the National Fire Protection Research Foundation. It is expected that the proposed design criteria will be added to the standard when a thorough analysis of the test data is completed.

A.3.6.2.9 Quick-Response (QR) Sprinkler. Quick response is a listing for sprinklers that combines the deflector, frame, and body of a spray sprinkler with a fast-response element [see 3.6.1(a)(1)] to create a technology that will respond quickly in the event of a fire and deliver water in the same fashion as other types of spray sprinklers.

A.3.6.4.2 Dry Sprinkler. Under certain ambient conditions, wet pipe systems having dry-pendent (or upright) sprinklers can freeze due to heat loss by conduction. Therefore, due consideration should be given to the amount of heat maintained in the heated space, the length of the nipple in the heated space, and other relevant factors.

Dry sprinklers are intended to extend into an unheated area from a wet pipe system or to be used on a dry pipe system.

A.3.7.1 Obstructed Construction. The following are examples of obstructed construction. The definitions are provided to assist the user in determining the type of construction feature.

- (1) *Beam and Girder Construction.* The term *beam and girder construction* as used in this standard includes noncombustible and combustible roof or floor decks supported by wood beams of 4 in. (102 mm) or greater nominal thickness or concrete or steel beams spaced 3 ft to 7½ ft (0.9 m to 2.3 m) on center and either supported on or framed into girders. [Where supporting a wood plank deck, this includes semi-mill and panel construction, and where supporting (with steel framing) gypsum plank, steel deck, concrete, tile, or similar material, this includes much of the so-called noncombustible construction.]
- (2) *Concrete Tee Construction.* The term *concrete tee construction* as it is used in this standard refers to solid concrete members with stems (legs) having a nominal thickness less than the nominal height. See Figure A.3.7.1(a) for examples of

concrete tee construction.

- (3) *Composite Wood Joist Construction.* The term *composite wood joist construction* refers to wood beams of “I” cross section constructed of wood flanges and solid wood web, supporting a floor or roof deck. Composite wood joists can vary in depth up to 48 in. (1.2 m), can be spaced up to 48 in. (1.2 m) on centers, and can span up to 60 ft (18 m) between supports. Joist channels should be firestopped to the full depth of the joists with material equivalent to the web construction so that individual channel areas do not exceed 300 ft² (27.9 m²). [See Figure A.3.7.1(b) for an example of composite wood joist construction.]
- (4) *Panel Construction.* The term *panel construction* as used in this standard includes ceiling panels formed by members capable of trapping heat to aid the operation of sprinklers and limited to a maximum of 300 ft² (27.9 m²) in area. There should be no unfilled penetrations in the cross-sectional area of the bounding structural members including the interface at the roof. Beams spaced more than 7½ ft (2.3 m) apart and framed into girders qualify as panel construction, provided the 300 ft² (27.9 m²) area limitation is met.
- (5) *Semi-Mill Construction.* The term *semi-mill construction* as used in this standard refers to a modified standard mill construction, where greater column spacing is used and beams rest on girders.
- (6) *Wood Joist Construction.* The term *wood joist construction* refers to solid wood members of rectangular cross section, which can vary from 2 in. to 4 in. (51 mm to 102 mm) nominal width and can be up to 14 in. (356 mm) nominal depth, spaced up to 3 ft (0.9 m) on centers, and can span up to 40 ft (12 m) between supports, supporting a floor or roof deck. Solid wood members less than 4 in. (102 mm) nominal width and up to 14 in. (356 mm) nominal depth, spaced more than 3 ft (0.9 m) on centers, are also considered as wood joist construction.
- (7) *Bar Joist Construction with Fireproofing.* In order to meet building codes, bar joists are often covered with fireproofing materials. In such an event, if greater than 30 percent of the area of the joist is obstructed, it should be considered obstructed construction.

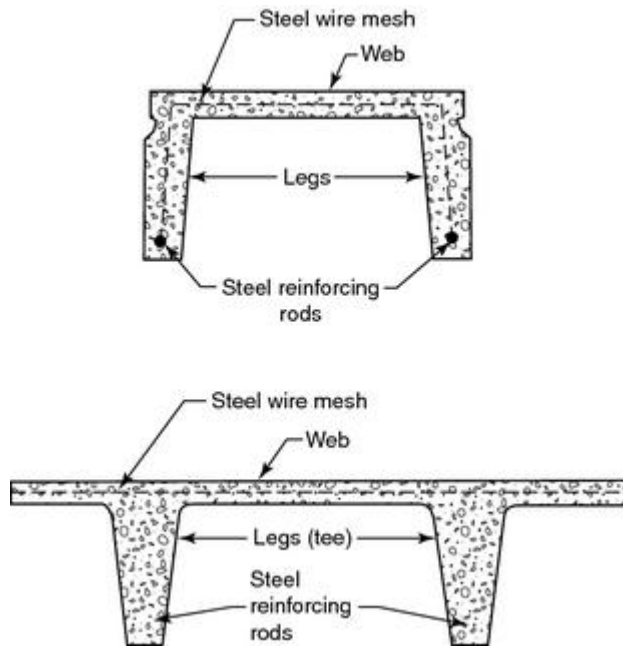

FIGURE A.3.7.1(a) Typical Concrete Tee Construction.

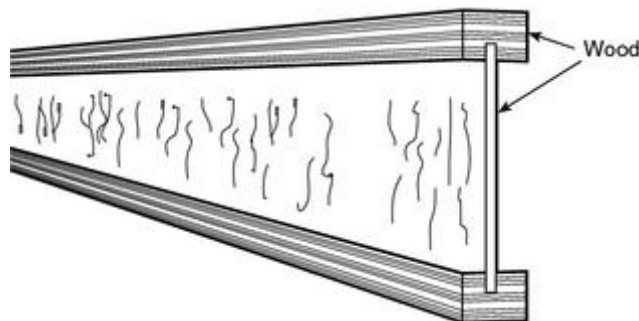

FIGURE A.3.7.1(b) Typical Composite Wood Joist Construction.

A.3.7.2 Unobstructed Construction. The following are examples of unobstructed construction. The definitions are provided to assist the user in determining the type of construction feature.

- (1) *Bar Joist Construction.* The term *bar joist construction* refers to construction employing joists consisting of steel truss-shaped members. Wood truss-shaped members, which consist of wood top and bottom chord members not exceeding 4 in. (102 mm) in depth with steel tube or bar webs, are also defined as bar joists. Bar joists include noncombustible or combustible roof or floor decks on bar joist construction. [See Figure A.3.7.2(a) and Figure A.3.7.2(b) for examples of bar joist construction.]
- (2) *Open-Grid Ceilings.* The term *open-grid ceilings* as used in this standard refers to ceilings in which the openings are ¼ in. (6.4 mm) or larger in the least dimension, the thickness of the ceiling material does not exceed the least dimension of the openings, and the openings constitute at least 70 percent of the ceiling area.

- (3) *Smooth Ceiling Construction.* The term *smooth ceiling construction* as used in this standard includes the following:
- (a) Flat slab, pan-type reinforced concrete
 - (b) Continuous smooth bays formed by wood, concrete, or steel beams spaced more than 7½ ft (2.3 m) on centers — beams supported by columns, girders, or trusses
 - (c) Smooth roof or floor decks supported directly on girders or trusses spaced more than 7½ ft (2.3 m) on center
 - (d) Smooth monolithic ceilings of at least ¾ in. (19 mm) of plaster on metal lath or a combination of materials of equivalent fire-resistive rating attached to the underside of wood joists, wood trusses, and bar joists
 - (e) Open-web-type steel beams, regardless of spacing
 - (f) Smooth shell-type roofs, such as folded plates, hyperbolic paraboloids, saddles, domes, and long barrel shells
 - (g) Suspended ceilings of combustible or noncombustible construction
 - (h) Smooth monolithic ceilings with fire resistance less than that specified under item (d) and attached to the underside of wood joists, wood trusses, and bar joists

Combustible or noncombustible floor decks are permitted in the construction specified in A.3.7.2(3)(b) through (f). Item (b) would include standard mill construction.

- (4) *Standard Mill Construction.* The term *standard mill construction* as used in this standard refers to heavy timber construction as defined in NFPA 220, *Standard on Types of Building Construction*.
- (5) *Wood Truss Construction.* The term *wood truss construction* refers to parallel or pitched wood chord members connected by open wood members (webbing) supporting a roof or floor deck. Trusses with steel webbing, similar to bar joist construction, having top and bottom wood chords exceeding 4 in. (102 mm) in depth should also be considered wood truss construction. [See Figure A.3.7.2(c).]

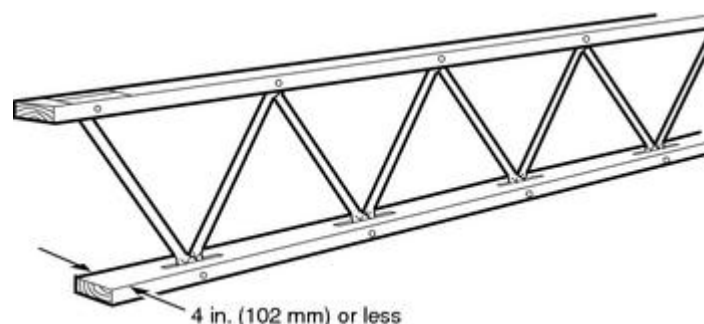

FIGURE A.3.7.2(a) Wood Bar Joist Construction.

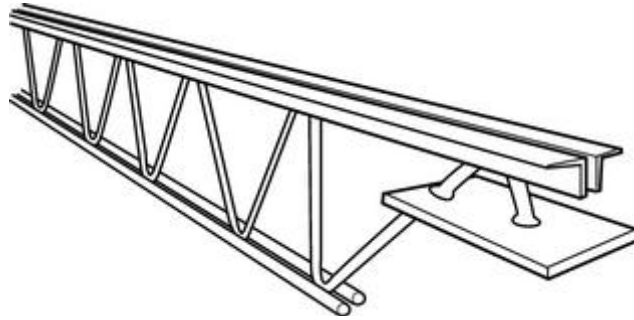

FIGURE A.3.7.2(b) Open-Web Bar Joist Construction.

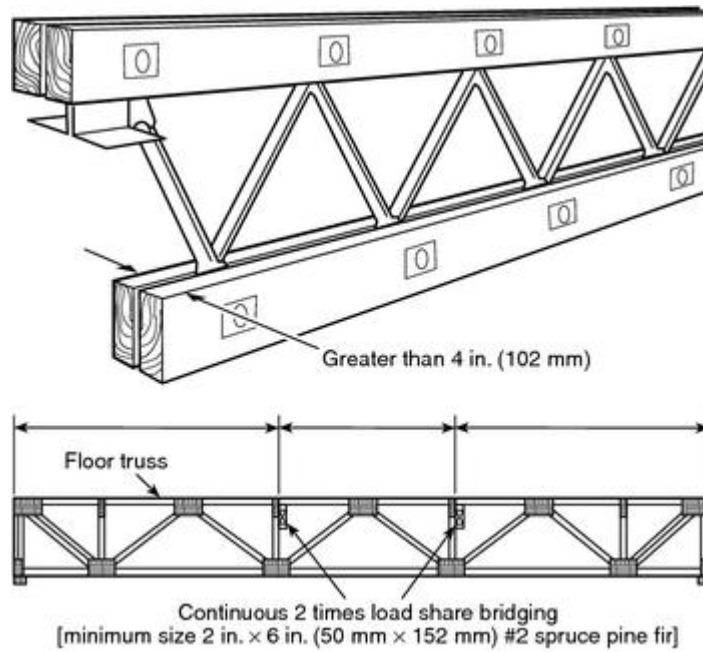

FIGURE A.3.7.2(c) Examples of Wood Truss Construction.

A.3.8.1.11 Private Fire Service Main. See Figure A.3.8.1.11.

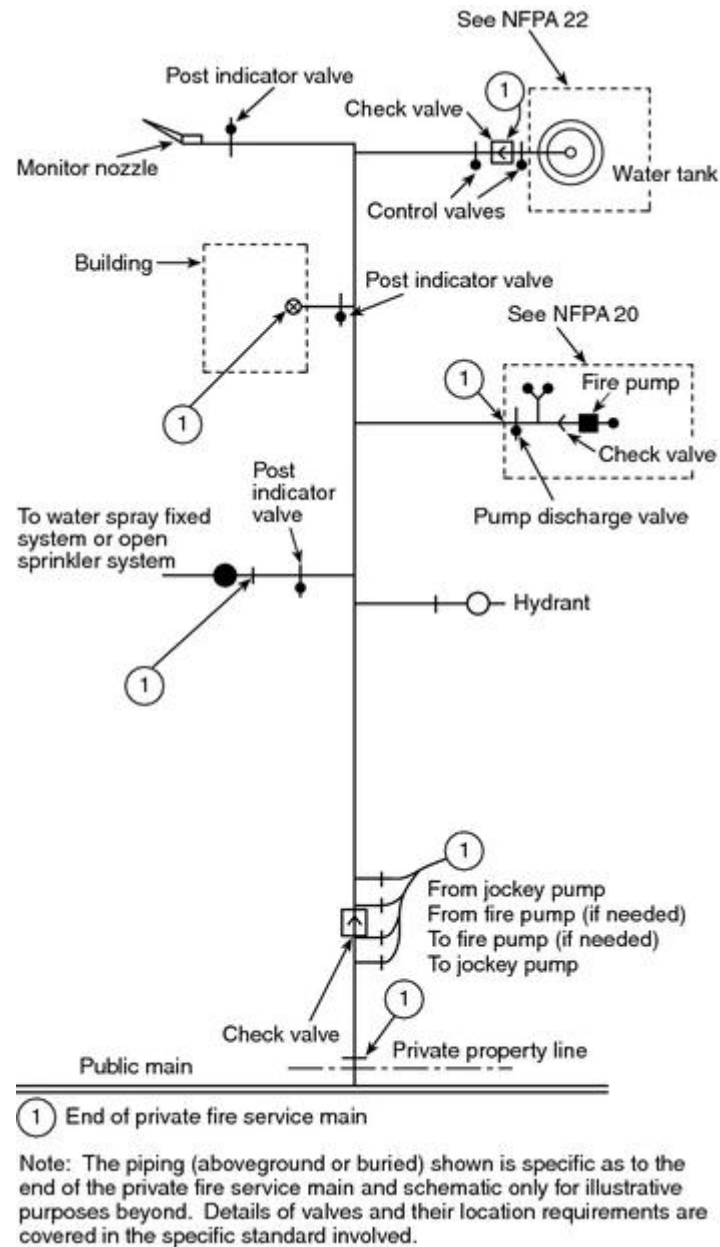

FIGURE A.3.8.1.11 Typical Private Fire Service Main.

A.3.9.1.1 Available Height for Storage. For new sprinkler installations, the maximum height of storage is the height at which commodities can be stored above the floor where the minimum required unobstructed space below sprinklers is maintained. For the evaluation of existing situations, the maximum height of storage is the maximum existing height if space between the sprinklers and storage is equal to or greater than required.

A.3.9.1.5 Compartmented. Cartons used in most of the Factory Mutual–sponsored plastic tests involved an ordinary 200 lb (90.7 kg) test of outside corrugated cartons with five layers of vertical pieces of corrugated carton used as dividers on the inside. There were also single horizontal pieces of corrugated carton between each layer.

Other tests sponsored by the Society of Plastics Industry, Industrial Risk Insurers, Factory Copyright NFPA

Mutual, and Kemper used two vertical pieces of carton (not corrugated) to form an “X” in the carton for separation of product. This arrangement was not considered compartmented, as the pieces of carton used for separations were flexible (not rigid), and only two pieces were used in each carton.

A.3.9.1.6 Container (Shipping, Master, or Outer Container). The term *container* includes items such as cartons and wrappings. Fire-retardant containers or tote boxes do not by themselves create a need for automatic sprinklers unless coated with oil or grease. Containers can lose their fire-retardant properties if washed. For obvious reasons, they should not be exposed to rainfall.

A.3.9.1.7 Conventional Pallets. See Figure A.3.9.1.7.

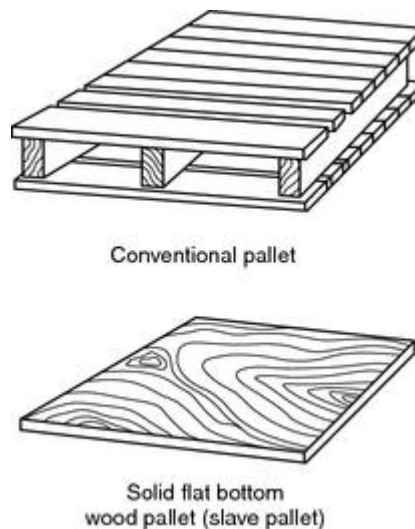

FIGURE A.3.9.1.7 Typical Pallets.

A.3.9.1.14 Miscellaneous Storage. The sprinkler system design criteria for miscellaneous storage at heights below 12 ft (3.7 m) are covered by this standard in Chapter 12. Chapter 12 describes design criteria, and Section 8.2 describes installation requirements (area limits). These requirements apply to all storage of 12 ft (3.7 m) or less in height.

A.3.9.1.17 Reinforced Plastic Pallet. See Figure A.3.9.1.17(a) and Figure A.3.9.1.17(b).

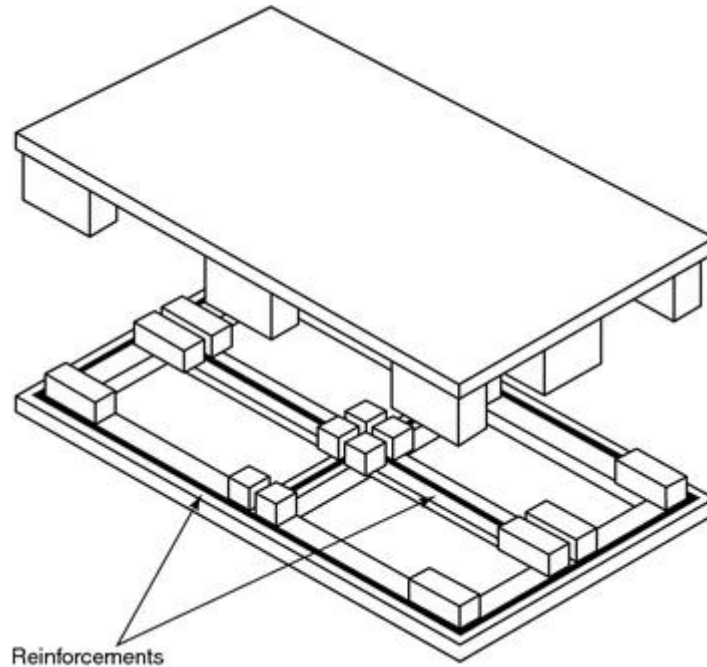

FIGURE A.3.9.17(a) Cut-Away Reinforced Plastic Pallet.

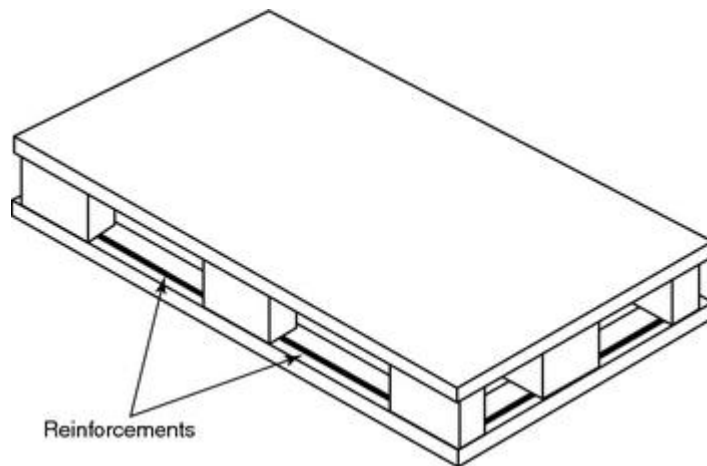

FIGURE A.3.9.17(b) Assembled Reinforced Plastic Pallet.

A.3.9.2.1.2 Open Array. Fire tests conducted to represent a closed array utilized 6 in. (152 mm) longitudinal flues and no transverse flues. Fire tests conducted to represent an open array utilized 12 in. (305 mm) longitudinal flues.

A.3.9.2.4 Pile Stability, Stable Piles. Pile stability performance has been shown to be a difficult factor to judge prior to a pile being subjected to an actual fire. In the test work completed, compartmented cartons (*see A.3.9.1.5, Compartmented*) have been shown to be stable under fire conditions. Tests also indicated cartons that were not compartmented tended to be unstable under fire conditions.

Storage on pallets, compartmented storage, and plastic components that are held in place by materials that do not deform readily under fire conditions are examples of stable storage.

A.3.9.2.5 Pile Stability, Unstable Piles. Leaning stacks, crushed bottom cartons, and reliance on combustible bands for stability are examples of potential pile instability under a fire condition. An increase in pile height tends to increase instability.

A.3.9.3.1 Aisle Width. See Figure A.3.9.3.1.

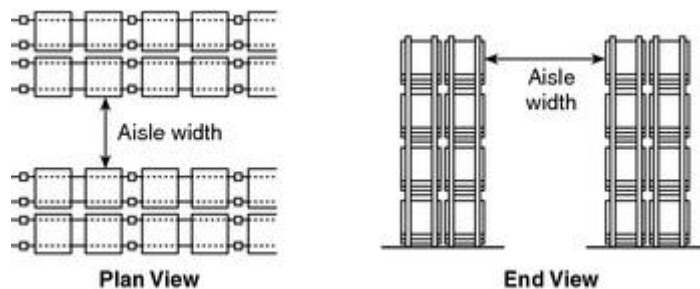

FIGURE A.3.9.3.1 Illustration of Aisle Width.

A.3.9.3.6 Longitudinal Flue Space. See Figure A.3.9.3.6.

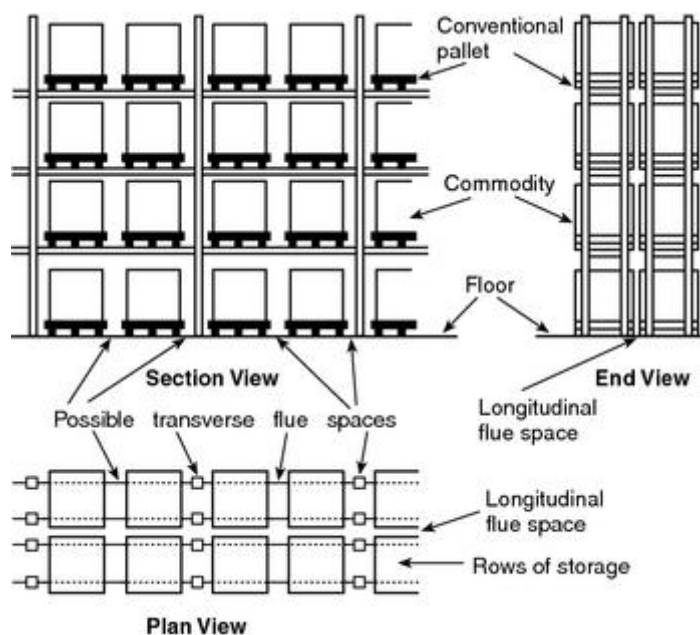

FIGURE A.3.9.3.6 Typical Double-Row (Back-to-Back) Rack Arrangement.

A.3.9.3.7 Rack. Rack storage as referred to in this standard contemplates commodities in a rack structure, usually steel. Many variations of dimensions are found. Racks can be single-row, double-row, or multiple-row, with or without solid shelving. The standard commodity used in most of the tests was 42 in. (1.07 m) on a side. The types of racks covered in this standard are as follows:

- (1) *Double-Row Racks.* Pallets rest on two beams parallel to the aisle. Any number of pallets can be supported by one pair of beams. [See Figure A.3.9.3.7(a) through Figure A.3.9.3.7(d).]
- (2) *Automatic Storage-Type Rack.* The pallet is supported by two rails running

perpendicular to the aisle. [See Figure A.3.9.3.7(e).]

- (3) *Multiple-Row Racks More Than Two Pallets Deep, Measured Aisle to Aisle.* These racks include drive-in racks, drive-through racks, flow-through racks, portable racks arranged in the same manner, and conventional or automatic racks with aisles less than 42 in. (1.07 m) wide. [See Figure A.3.9.3.7(f) through Figure A.3.9.3.7(i).]
- (4) *Movable Racks.* Movable racks are racks on fixed rails or guides. They can be moved back and forth only in a horizontal, two-dimensional plane. A moving aisle is created as abutting racks are either loaded or unloaded, then moved across the aisle to abut other racks. [See Figure A.3.9.3.7(k).]
- (5) *Solid Shelving.* Conventional pallet racks with plywood shelves on the shelf beams [see Figure A.3.9.3.7(c) and Figure A.3.9.3.7(d)]. These racks are used in special cases. (See Chapter 12.)
- (6) *Cantilever Rack.* The load is supported on arms that extend horizontally from columns. The load can rest on the arms or on shelves supported by the arms. [See Figure A.3.9.3.7(j).]

Load depth in conventional or automatic racks should be considered a nominal 4 ft (1.22 m). [See Figure A.3.9.3.7(b).]

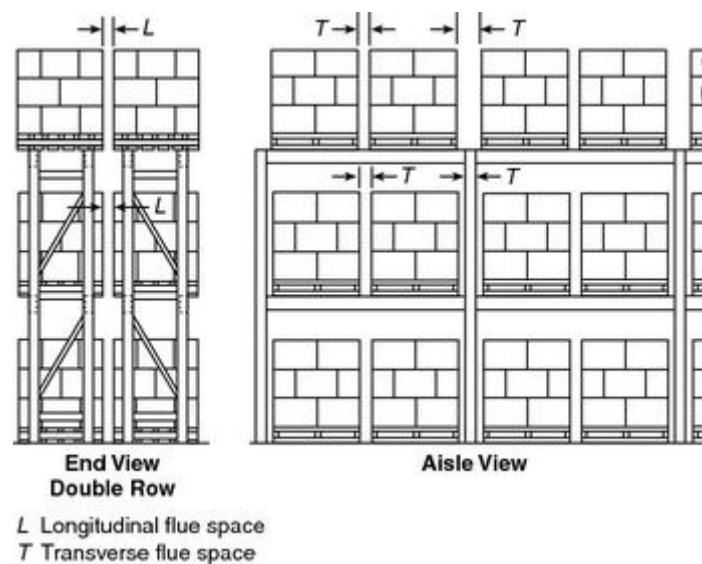
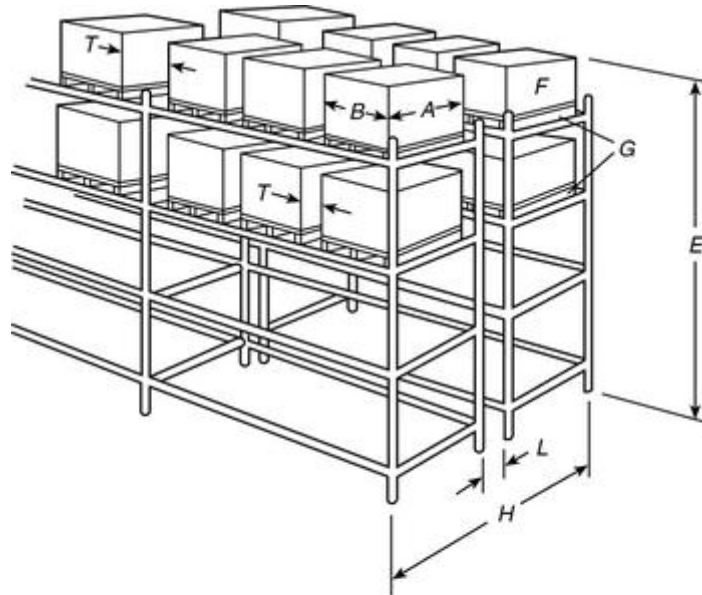
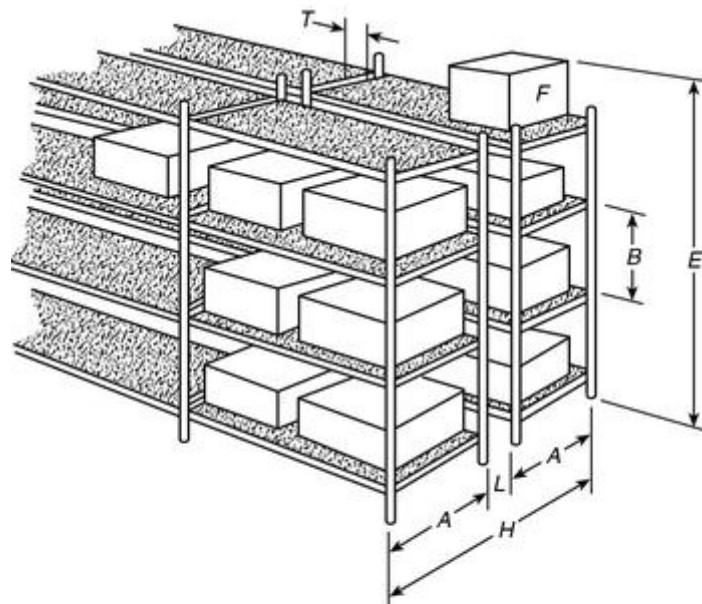

FIGURE A.3.9.3.7(a) Conventional Pallet Rack.



- | | |
|------------------|---------------------------|
| A Load depth | G Pallet |
| B Load width | H Rack depth |
| E Storage height | L Longitudinal flue space |
| F Commodity | T Transverse flue space |

FIGURE A.3.9.3.7(b) Double-Row Racks Without Solid or Slatted Shelves.



- | | |
|------------------|---------------------------|
| A Shelf depth | H Rack depth |
| B Shelf height | L Longitudinal flue space |
| E Storage height | T Transverse flue space |
| F Commodity | |

FIGURE A.3.9.3.7(c) Double-Row Racks with Solid Shelves.

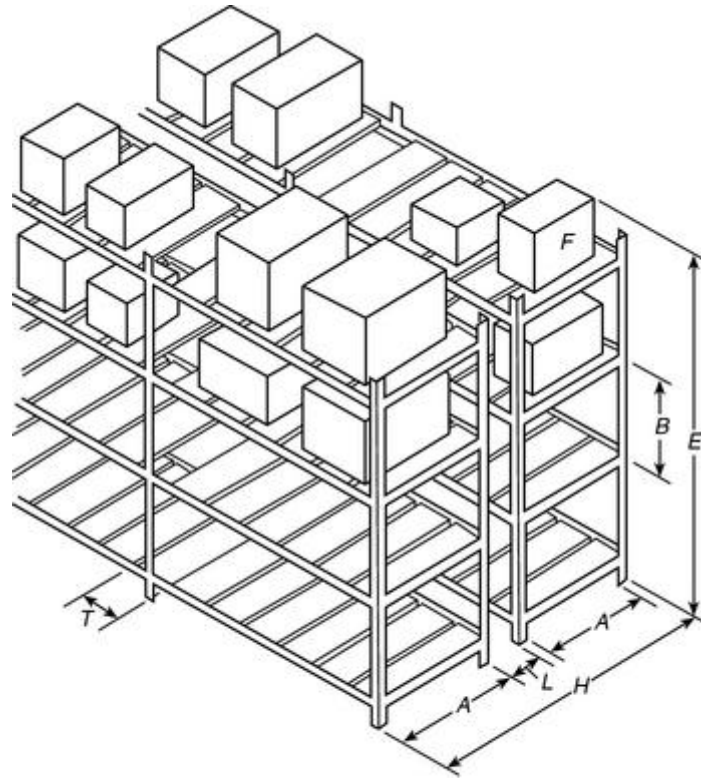

- | | |
|-------------------------|----------------------------------|
| <i>A</i> Shelf depth | <i>H</i> Rack depth |
| <i>B</i> Shelf height | <i>L</i> Longitudinal flue space |
| <i>E</i> Storage height | <i>T</i> Transverse flue space |
| <i>F</i> Commodity | |

FIGURE A.3.9.3.7(d) Double-Row Racks with Slatted Shelves.

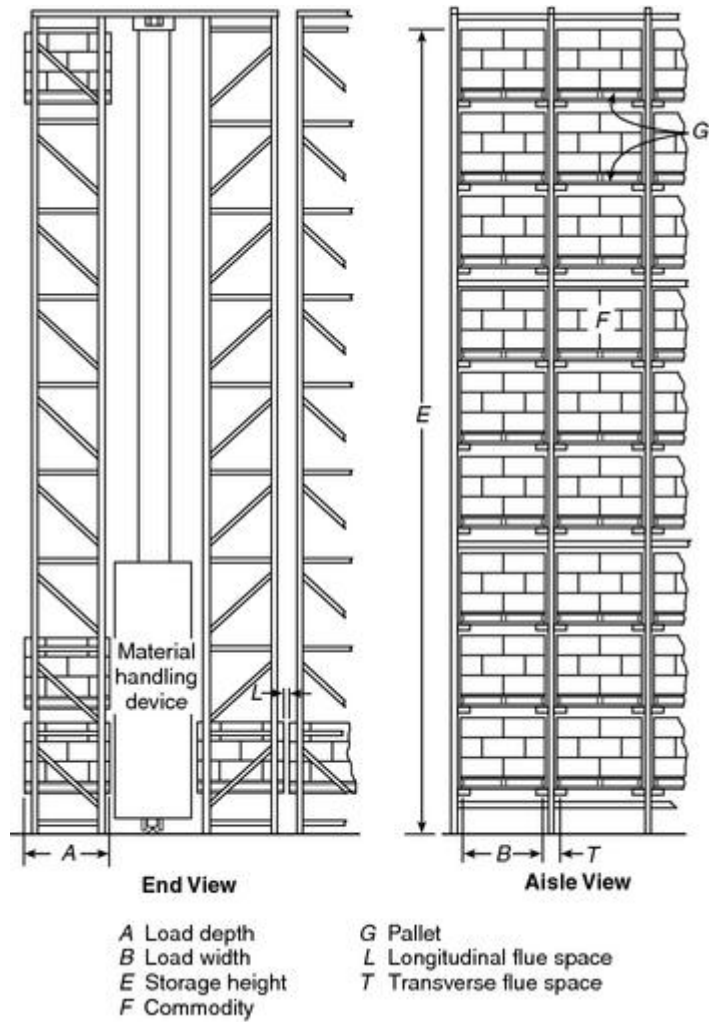

FIGURE A.3.9.3.7(e) Automatic Storage-Type Rack.

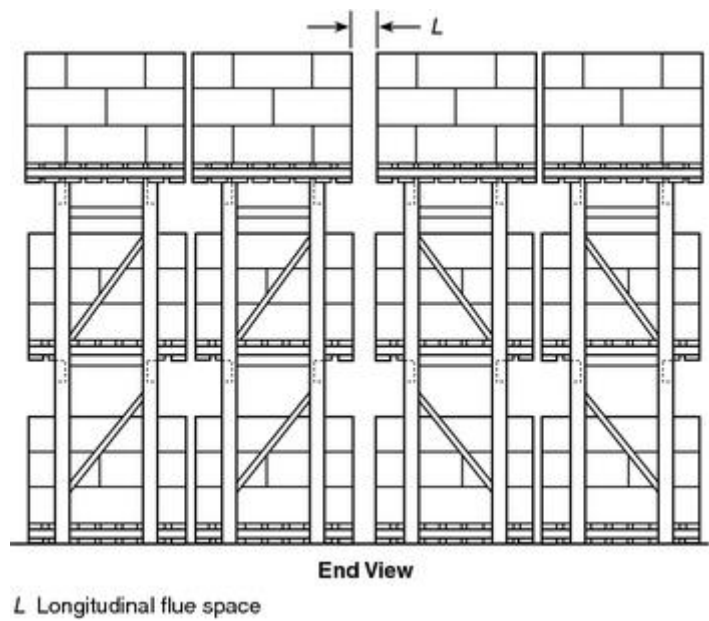

FIGURE A.3.9.3.7(f) Multiple-Row Rack to Be Served by a Reach Truck.

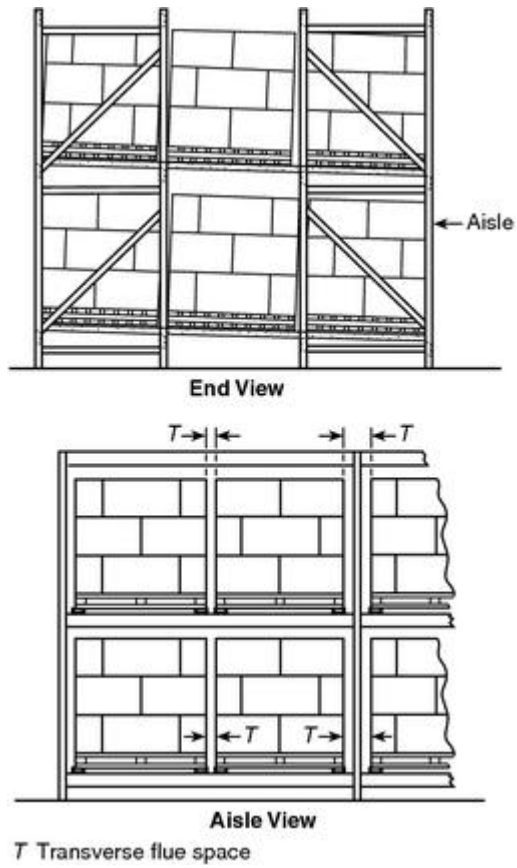

FIGURE A.3.9.3.7(g) Flow-Through Pallet Rack.

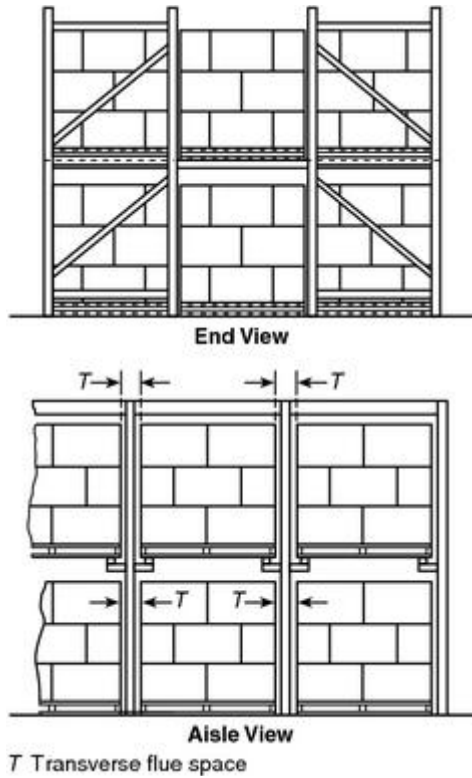

FIGURE A.3.9.3.7(h) Drive-In Rack — Two or More Pallets Deep (Fork Truck Drives into the Rack to Deposit and Withdraw Loads in the Depth of the Rack).

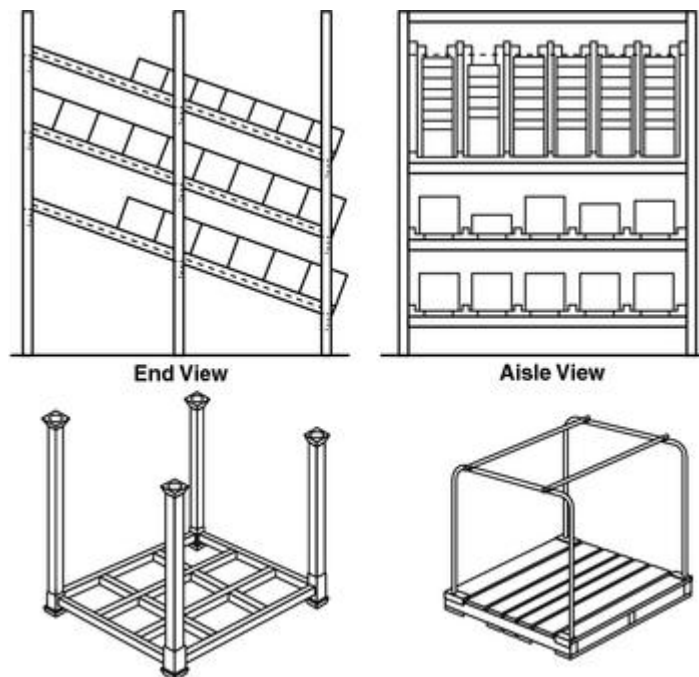

FIGURE A.3.9.3.7(i) Flow-Through Racks (Top) and Portable Racks (Bottom).

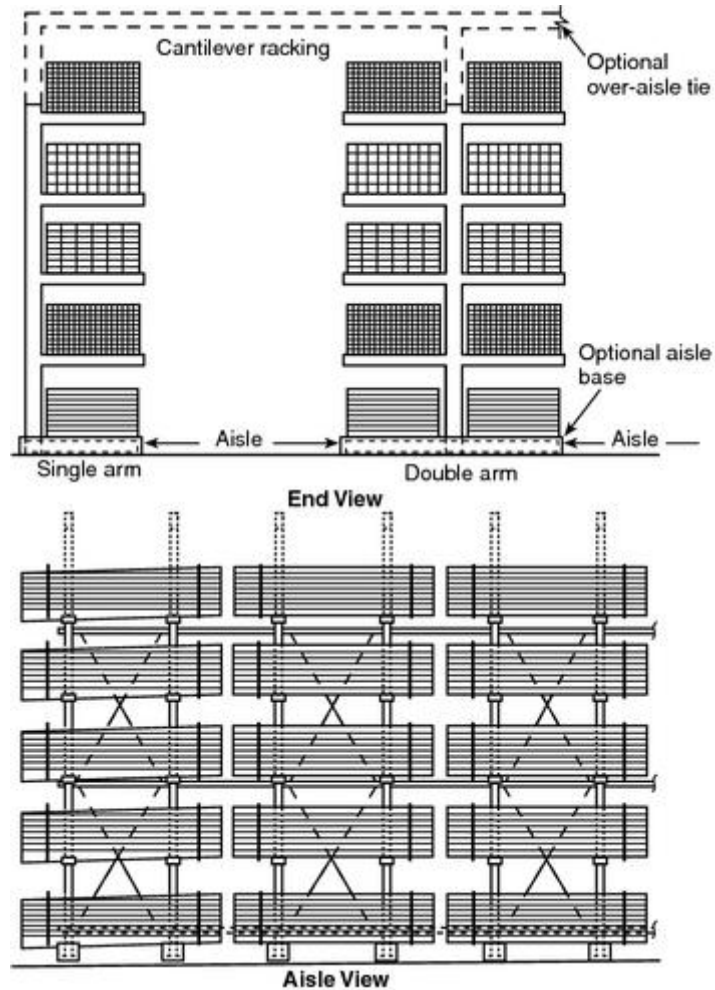

FIGURE A.3.9.3.7(j) Cantilever Rack.

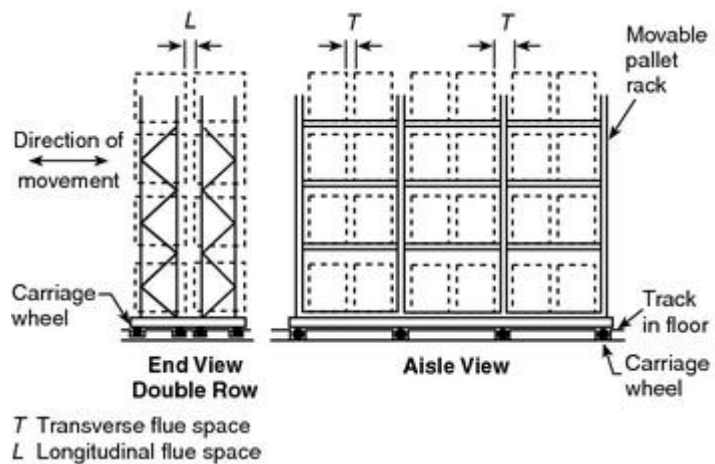

FIGURE A.3.9.3.7(k) Movable Rack.

A.3.9.4.4 Miscellaneous Tire Storage. The limitations on the type and size of storage are intended to identify those situations where tire storage is present in limited quantities and incidental to the main use of the building. Occupancies such as aircraft hangars, automobile

dealers, repair garages, retail storage facilities, automotive and truck assembly plants, and mobile home assembly plants are types of facilities where miscellaneous storage could be present.

A.3.9.4.9 Rubber Tire Rack Illustrations. Figure A.3.9.4.9(a) through Figure A.3.9.4.9(g) do not necessarily cover all possible rubber tire storage configurations.

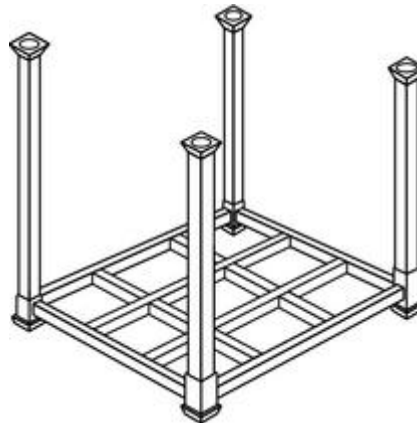

FIGURE A.3.9.4.9(a) Typical Open Portable Tire Rack Unit.

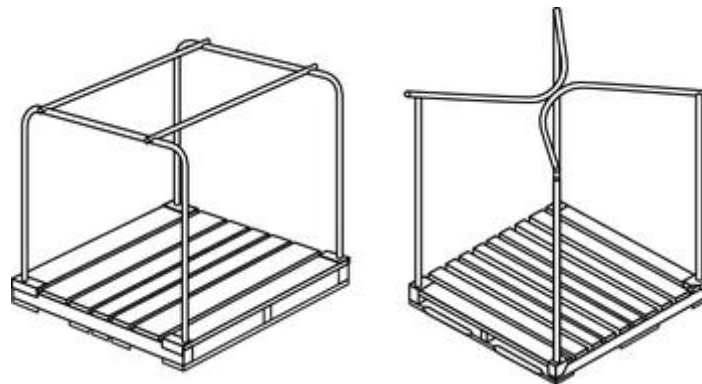

FIGURE A.3.9.4.9(b) Typical Palletized Portable Tire Rack Units.

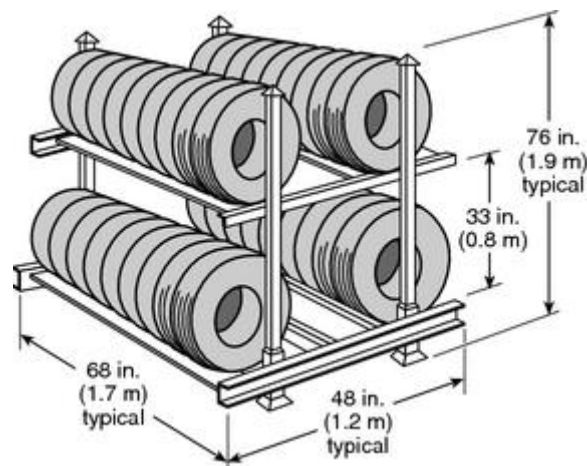
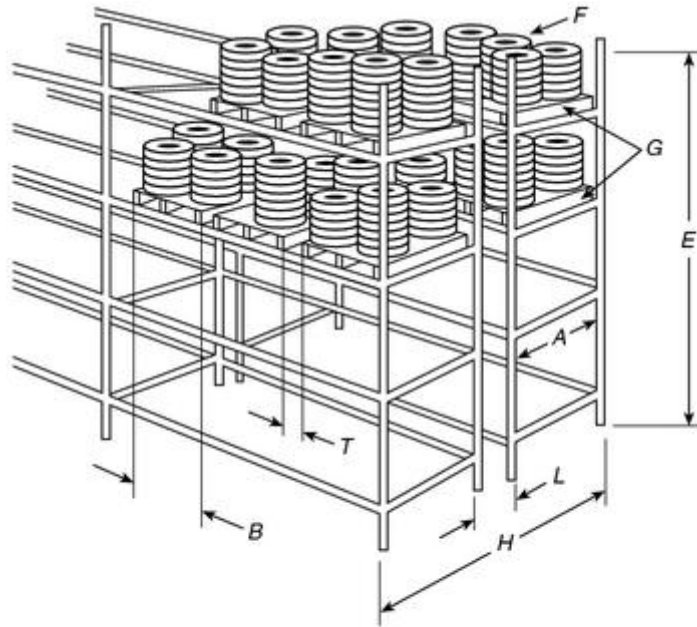

FIGURE A.3.9.4.9(c) Open Portable Tire Rack.



- | | |
|------------------|---------------------------|
| A Load depth | G Pallet |
| B Load width | H Rack depth |
| E Storage height | L Longitudinal flue space |
| F Commodity | T Transverse flue space |

FIGURE A.3.9.4.9(d) Double-Row Fixed Tire Rack Storage.

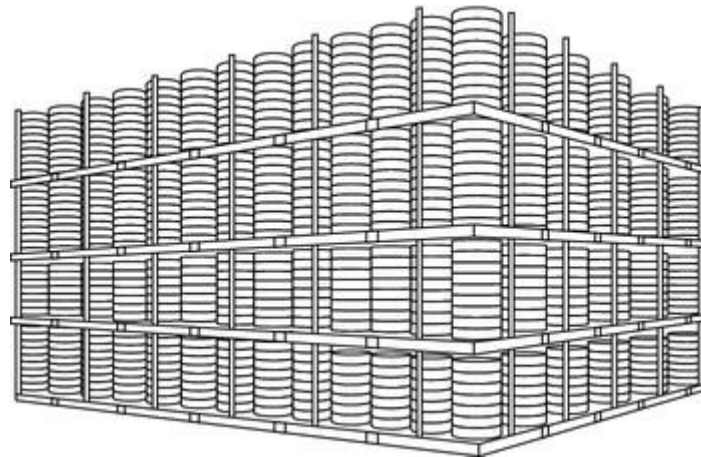

FIGURE A.3.9.4.9(e) Palletized Portable Tire Rack, On-Side Storage Arrangement (Banded or Unbanded).



FIGURE A.3.9.4.9(f) On-Floor Storage; On-Tread, Normally Banded.

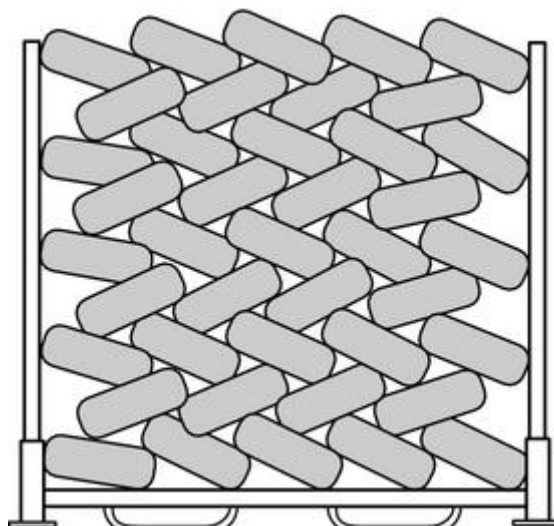

FIGURE A.3.9.4.9(g) Typical Laced Tire Storage.

A.3.9.5.1.3 Standard Array (Paper). The occasional presence of partially used rolls on top of columns of otherwise uniform diameter rolls does not appreciably affect the burning characteristics.

A.3.9.5.6.3 Wrapped Roll Paper Storage. Rolls that are completely protected with a heavyweight kraft wrapper on both sides and ends are subject to a reduced degree of fire hazard. Standard methods for wrapping and capping rolls are outlined in Figure A.3.9.5.6.3.

In some cases, rolls are protected with laminated wrappers, using two sheets of heavy kraft with a high-temperature wax laminate between the sheets. Where using this method, the overall weight of wax-laminated wrappers should be based on the basis weight per 1000 ft² (92.9 m²) of the outer sheet only, rather than on the combined basis weight of the outer and inner laminated wrapper sheets. A properly applied wrapper can have the effect of changing the class of a given paper to essentially that of the wrapper material. The effect of applying a wrapper to tissue has not been determined by test.

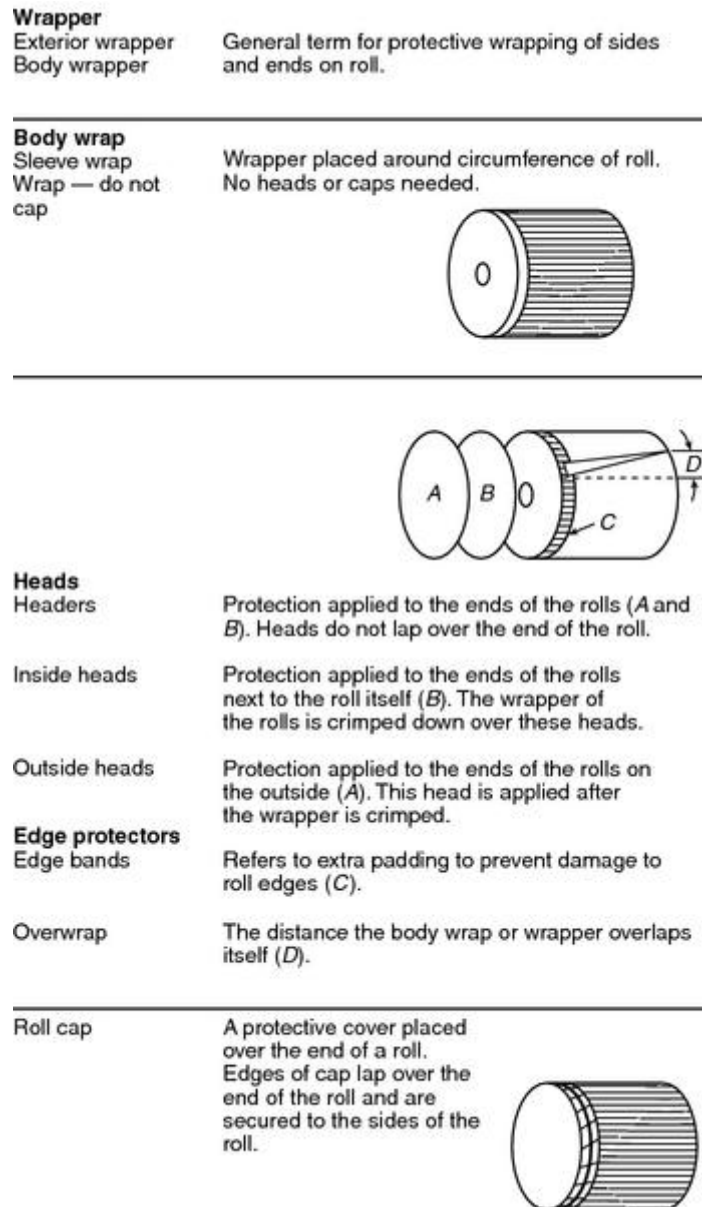

FIGURE A.3.9.5.6.3 Wrapping and Capping Terms and Methods.

A.3.9.5.7 Roll Paper Storage Height. The size of rolls and limitations of mechanical handling equipment should be considered in determining maximum storage height.

A.3.9.6.1 Baled Cotton. See Table A.3.9.6.1.

Table A.3.9.6.1 Typical Cotton Bale Types and Approximate Sizes

Bale Type	Dimensions		Average Weight		Volume	
	in.	mm	lb	kg	ft ³	m ³
Compressed, standard	57 × 29 × 23	1448 × 736 × 584	500	226.8	22.0	0.62
Gin, standard	55 × 31 × 21	1397 × 787 × 533	500	226.8	20.7	0.58
Compressed, universal	58 × 25 × 21	1475 × 635 × 533	500	226.8	17.6	0.50

Table A.3.9.6.1 Typical Cotton Bale Types and Approximate Sizes

Bale Type	Dimensions		Average Weight		Volume	
	in.	mm	lb	kg	ft ³	m ³
Gin, universal	55 × 26 × 21	1397 × 660 × 533	500	226.8	17.4	0.49
Compressed, high density	58 × 22 × 21	1473 × 559 × 533	500	226.8	15.5	0.44
Densely packed baled cotton	55 × 21 × 27.6 to 35.4	1400 × 530 × 700 to 900	500	226.8	21.1	0.60

A.3.9.6.2 Tiered Storage. Untiered storage limits storage to the height of one bale, on side or on end. Sprinkler protection designed on this basis would likely prohibit future tiering without redesign of the sprinkler system.

A.3.10.4 Heat-Sensitive Material. The backbone of the fire protection philosophy for U.S. flagged vessels and passenger vessels that trade internationally is limiting a fire to the compartment of origin by passive means. Materials that do not withstand a 1-hour fire exposure when tested in accordance with ASTM E 119, *Standard Test Methods for Fire Tests of Building Construction and Materials*, are considered “heat sensitive.” (See Figure A.3.10.4.)

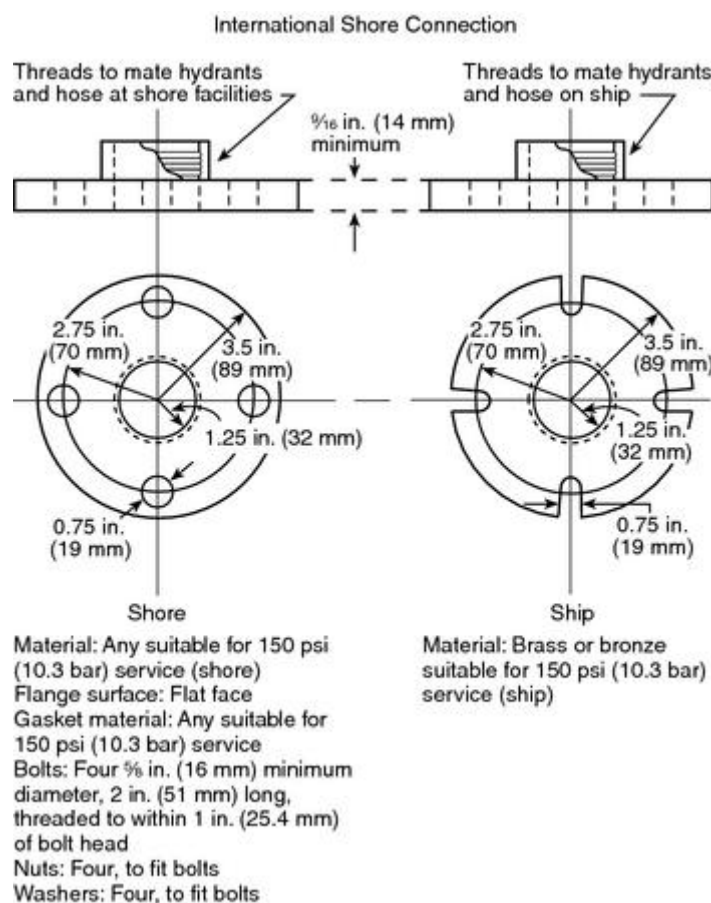

FIGURE A.3.10.4 International Shore Fire Connection.

A.3.10.8 Marine System. Some types of sprinkler systems can closely resemble marine systems, such as a system installed on a floating structure that has a permanent water supply connection to a public main. For these types of systems, judgment should be used in determining if certain aspects of Chapter 25 are applicable.

A.3.10.9 Marine Thermal Barrier. A marine thermal barrier is typically referred to as a B-15 boundary.

A.4.3 A building constructed where the expected occupancy hazard and commodity classification of tenant uses are unknown at the time of the design and installation of the sprinkler system presents special problems due to unknown factors of future tenants and uses. The design of sprinkler systems for such buildings should be carefully reviewed with the owners, builders, leasing agents, and local authorities having jurisdiction prior to the selection of design criteria and installation of the system. Consideration should be given to the available height for storage, as well as the occupancy hazards of potential tenants and their likely storage needs.

It is the intent of Section 4.3 to provide the owner's certificate for all new systems and where there is a change of occupancy and/or building use.

A.4.4 Biocides and other chemicals that are approved and used for the prevention and mitigation of MIC and that do not adversely affect the fire-fighting properties of the water or the performance of the fire sprinkler system components are not prohibited.

A.5.1 Occupancy examples in the listings as shown in the various hazard classifications are intended to represent the norm for those occupancy types. Unusual or abnormal fuel loadings or combustible characteristics and susceptibility for changes in these characteristics, for a particular occupancy, are considerations that should be weighed in the selection and classification.

The light hazard classification is intended to encompass residential occupancies; however, this is not intended to preclude the use of listed residential sprinklers in residential occupancies or residential portions of other occupancies.

A.5.2 Light hazard occupancies include occupancies having uses and conditions similar to the following:

Animal shelters

Churches

Clubs

Eaves and overhangs, if of combustible construction with no combustibles beneath

Educational

Hospitals, including animal hospitals and veterinary facilities

Institutional

Kennels

Copyright NFPA

Libraries, except large stack rooms

It is not the committee's intent to automatically equate library bookshelves with ordinary hazard occupancies or with library stacks. Typical library bookshelves of approximately 8 ft in height, containing books stored vertically on end, held in place in close association with each other, with aisles wider than 30 in. can be considered to be light hazard occupancies. Similarly, library stack areas, which are more akin to shelf storage or record storage, as defined in NFPA 232, *Standard for the Protection of Records*, should be considered to be ordinary hazard occupancies.

Museums

Nursing or convalescent homes

Offices, including data processing

Residential

Restaurant seating areas

Theaters and auditoriums, excluding stages and prosceniums

Unused attics

A.5.3 For purposes of these definitions, Class I, Class II, Class III, and Class IV commodities would be considered to have moderate rates of heat release, while Group A plastics would be considered to have high rates of heat release. Stockpiles are considered to include display merchandise (mercantile) and arrangements of combustibles ancillary to operations within the occupancy as opposed to dedicated storage areas where the fire loading is generally more severe.

A.5.3.1 Ordinary hazard occupancies (Group 1) include occupancies having uses and conditions similar to the following:

Automobile parking and showrooms

Bakeries

Beverage manufacturing

Canneries

Dairy products manufacturing and processing

Electronic plants

Glass and glass products manufacturing

Laundries

Restaurant service areas

A.5.3.2 Ordinary hazard occupancies (Group 2) include occupancies having uses and conditions similar to the following:

Agricultural facilities

Copyright NFPA

Barns and stables

Cereal mills

Chemical plants — ordinary

Confectionery products

Distilleries

Dry cleaners

Exterior Loading Docks

Exterior loading docks only utilized for loading and unloading should be classified as OH2. Where utilized for storage, exterior loading docks and all interior loading docks should be protected based upon the actual occupancy, the materials handled on the dock, as if the materials were actually stored in that configuration.

Feed mills

Horse stables

Leather goods manufacturing

Libraries — large stack room areas

Machine shops

Metal working

Mercantile

Paper and pulp mills

Paper process plants

Piers and wharves

Post offices

Printing and publishing

Racetrack stable/kennel areas, including those stable/kennel areas, barns, and associated buildings at state, county, and local fairgrounds

Repair garages

Resin application area

Stages

Textile manufacturing

Tire manufacturing

Tobacco products manufacturing

Wood machining

Copyright NFPA

Wood product assembly

A.5.4.1 Extra hazard occupancies (Group 1) include occupancies having uses and conditions similar to the following:

Aircraft hangars (except as governed by NFPA 409, *Standard on Aircraft Hangars*)

Combustible hydraulic fluid use areas

Die casting

Metal extruding

Plywood and particle board manufacturing

Printing [using inks having flash points below 100°F (38°C)]

Rubber reclaiming, compounding, drying, milling, vulcanizing

Saw mills

Textile picking, opening, blending, ginning, or carding, combining of cotton, synthetics, wool shoddy, or burlap

Upholstering with plastic foams

A.5.4.2 Extra hazard occupancies (Group 2) include occupancies having uses and conditions similar to the following:

Asphalt saturating

Flammable liquids spraying

Flow coating

Manufactured home or modular building assemblies (where finished enclosure is present and has combustible interiors)

Open oil quenching

Plastics processing

Solvent cleaning

Varnish and paint dipping

A.5.5 Other NFPA standards contain design criteria for fire control or fire suppression (*see Section 5.5 and Chapter 2*). While these can form the basis of design criteria, this standard describes the methods of design, installation, fabrication, calculation, and evaluation of water supplies that should be used for the specific design of the system.

Other NFPA standards contain sprinkler system design criteria for fire control or suppression of specific hazards. This information has been either referenced or copied into Chapter 21 using NFPA's extract policy.

A.5.6 Specification of the type, amount, and arrangement of combustibles for any commodity classification is essentially an attempt to define the potential fire severity, based

Copyright NFPA

on its burning characteristics, so the fire can be successfully controlled by the prescribed sprinkler protection for the commodity class. In actual storage situations, however, many storage arrays do not fit precisely into one of the fundamental classifications; therefore, the user needs to make judgments after comparing each classification to the existing storage conditions. Storage arrays consist of thousands of products, which make it impossible to specify all the acceptable variations for any class. As an alternative, a variety of common products are classified in this appendix based on judgment, loss experience, and fire test results.

Table A.5.6 provides examples of commodities not addressed by the classifications in Section 5.6.

Table A.5.6.3 is an alphabetized list of commodities with corresponding classifications.

Table A.5.6.3.1 through Table A.5.6.3.4 and Table A.5.6.4.1 provide examples of commodities within a specific class.

Table A.5.6 Examples of Commodities Not Addressed by the Classifications in Section 5.6

Boxes, Crates

- Empty, wood slatted*

Lighters (butane)

- Loose in large containers (Level 3 aerosol)
-

*Should be treated as idle pallets.

A.5.6.1.1 Commodity classification is governed by the types and amounts of materials (e.g., metal, paper, wood, plastics) that are a part of a product and its primary packaging. However, in a storage or warehousing situation, classification is also affected by such factors as the primary storage or shipping container material, the amount of air space, and the location of the more hazardous materials within the container. For example, a Group A plastic product enclosed in a five- or six-sided metal container can be considered Class II, while a ceramic product heavily wrapped in tissue paper and placed in a corrugated carton could be Class III.

A.5.6.3 See Table A.5.6.3.

Table A.5.6.3 Alphabetized Listing of Commodity Classes

Commodity	Commodity Class
Aerosols	
Cartoned or uncartoned — Level 1	Class III
Alcoholic Beverages	
Cartoned or uncartoned	
- Up to 20 percent alcohol in metal, glass, or ceramic containers	Class I

**Table A.5.6.3 Alphabetized Listing of
Commodity Classes**

Commodity	Commodity Class
- Up to 20 percent alcohol in wood containers	Class II
Ammunition	
Small arms, shotgun — packaged, cartoned	Class IV
Appliances, Major (e.g., stoves, refrigerators)	
- Not packaged, no appreciable plastic exterior trim	Class I
- Corrugated, cartoned (no appreciable plastic trim)	Class II
Baked Goods	
Cookies, cakes, pies	
- Frozen, packaged in cartons ^a	Class II
- Packaged, in cartons	Class III
Batteries	
Dry cells (nonlithium or similar exotic metals)	
- Packaged in cartons	Class I
- Blister-packed in cartons	Class II
Automobile — filled ^b	Class I
Truck or larger — empty or filled ^b	Group A plastics
Beans	
Dried — packaged, cartoned	Class III
Bottles, Jars	
Empty, cartoned	
- Glass	Class I
- Plastic PET (polyethylene terephthalate)	Class IV
Filled noncombustible powders	
- Plastic PET	Class II
- Glass, cartoned	Class I
- Plastic, cartoned [less than 1 gal (3.8 L)]	Class IV
- Plastic, uncartoned (other than PET), any size	Group A plastics
- Plastic, cartoned or exposed [greater than 1 gal (3.8 L)]	Group A plastics
- Plastic, solid plastic crates	Group A plastics
- Plastic, open plastic crates	Group A plastics
Filled noncombustible liquids	
- Glass, cartoned	Class I

**Table A.5.6.3 Alphabetized Listing of
Commodity Classes**

Commodity	Commodity Class
- Plastic, cartoned [less than 5 gal (18.9 L)]	Class I
- Plastic, open or solid plastic crates ^c	Group A plastics
- Plastic, PET	Class I
Boxes, Crates	
- Empty, wood, solid walls	Class II
- Empty, wood, slatted ^d	Outside of scope
Bread	
Wrapped cartoned	Class III
Butter	
Whipped spread	Class III
Candles	
Packaged, cartoned	
- Treat as expanded plastic	Group A plastics
Candy	
Packaged, cartoned	Class III
Canned Foods	
In ordinary cartons	Class I
Cans	
Metal — empty	Class I
Carpet Tiles	
Cartoned	Group A plastics
Cartons	
Corrugated	
- Unassembled (neat piles)	Class III
- Partially assembled	Class IV
Wax coated, single walled	Group A plastics
Cement	
Bagged	Class I
Cereals	
Packaged, cartoned	Class III
Charcoal	
Bagged — standard	Class III
Cheese	
- Packaged, cartoned	Class III
- Wheels, cartoned	Class III
Chewing Gum	
Packaged, cartoned	Class III

**Table A.5.6.3 Alphabetized Listing of
Commodity Classes**

Commodity	Commodity Class
Chocolate	
Packaged, cartoned	Class III
Cloth	
Cartoned and not cartoned	
- Natural fiber, viscose	Class III
- Synthetic ^e	Class IV
Cocoa Products	
Packaged, cartoned	Class III
Coffee	
- Canned, cartoned	Class I
- Packaged, cartoned	Class III
Coffee Beans	
Bagged	Class III
Cotton	
Packaged, cartoned	Class III
Diapers	
- Cotton, linen	Class III
- Disposable with plastics and nonwoven fabric (in cartons)	Class IV
- Disposable with plastics and nonwoven fabric (uncartoned), plastic wrapped	Group A plastics
Dried Foods	
Packaged, cartoned	Class III
Fertilizers	
Bagged	
- Phosphates	Class I
- Nitrates	Class II
Fiberglass Insulation	
- Paper-backed rolls, bagged or unbagged	Class IV
File Cabinets	
Metal	
- Cardboard box or shroud	Class I
Fish or Fish Products	
Frozen	
- Nonwaxed, nonplastic packaging	Class I
- Waxed-paper containers, cartoned	Class II
- Boxed or barreled	Class II
- Plastic trays, cartoned	Class III
Canned	
- Cartoned	Class I
Frozen Foods	
Nonwaxed, nonplastic packaging	Class I
- Waxed-paper containers, cartoned	Class II

Copyright NFPA

**Table A.5.6.3 Alphabetized Listing of
Commodity Classes**

Commodity	Commodity Class
- Plastic trays	Class III
Fruit	
Fresh	
- Nonplastic trays or containers	Class I
- With wood spacers	Class I
Furniture	
Wood	
- No plastic coverings or foam plastic cushioning	Class III
- With plastic coverings	Class IV
- With foam plastic cushioning	Group A plastics
Grains — Packaged in Cartons	
- Barley	Class III
- Rice	Class III
- Oats	Class III
Ice Cream	Class I
Leather Goods	Class III
Leather Hides	
Baled	Class II
Light Fixtures	
Nonplastic — cartoned	Class II
Lighters	
Butane	
- Blister-packed, cartoned	Group A plastics
- Loose in large containers (Level 3 aerosol)	Outside of scope
Liquor	
100 proof or less, 1 gal (3.8 L) or less, cartoned	
- Glass (palletized) ^f	Class IV
- Plastic bottles	Class IV
Marble	
Artificial sinks, countertops	
- Cartoned, crated	Class II
Margarine	
- Up to 50 percent oil (in paper or plastic containers)	Class III
- Between 50 percent and 80 percent oil (in any packaging)	Group A plastics
Matches	
Packaged, cartoned	

**Table A.5.6.3 Alphabetized Listing of
Commodity Classes**

Commodity	Commodity Class
- Paper	Class IV
- Wood	Group A plastics
Mattresses	
- Standard (box spring)	Class III
- Foam (in finished form)	Group A plastics
Meat, Meat Products	
- Bulk	Class I
- Canned, cartoned	Class I
- Frozen, nonwaxed, nonplastic containers	Class I
- Frozen, waxed-paper containers	Class II
- Frozen, expanded plastic trays	Class II
Metal Desks	
- With plastic tops and trim	Class I
Milk	
- Nonwaxed-paper containers	Class I
- Waxed-paper containers	Class I
- Plastic containers	Class I
- Containers in plastic crates	Group A plastics
Motors	
- Electric	Class I
Nail Polish	
- 1 oz to 2 oz (29.6 ml to 59.1 ml) glass, cartoned	Class IV
- 1 oz to 2 oz (29.6 ml to 59.1 ml) plastic bottles, cartoned	Group A plastics
Nuts	
- Canned, cartoned	Class I
- Packaged, cartoned	Class III
- Bagged	Class III
Paints	
Friction-top cans, cartoned	
- Water-based (latex)	Class I
- Oil-based	Class IV
Paper Products	
- Books, magazines, stationery, plastic-coated paper food containers, newspapers, cardboard games, or cartoned tissue products	Class III
- Tissue products, uncartoned and plastic wrapped	Group A plastics

**Table A.5.6.3 Alphabetized Listing of
Commodity Classes**

Commodity	Commodity Class
Paper, Rolled	
In racks or on side	Class III
- Medium- or heavyweight	
In racks	Class IV
- Lightweight	
Paper, Waxed	
Packaged in cartons	Class IV
Pharmaceuticals	
Pills, powders	
- Glass bottles, cartoned	Class II
- Plastic bottles, cartoned	Class IV
Nonflammable liquids	
- Glass bottles, cartoned	Class II
Photographic Film	
- Motion picture or bulk rolls of film in polycarbonate, polyethylene, or metal cans; polyethylene bagged in cardboard boxes	Class II
- 35 mm in metal film cartridges in polyethylene cans in cardboard boxes	Class III
- Paper, in sheets, bagged in polyethylene, in cardboard boxes	Class III
- Rolls in polycarbonate plastic cassettes, bulk wrapped in cardboard boxes	Class IV
Plastic Containers (except PET)	
- Noncombustible liquids or semiliquids in plastic containers less than 5 gal (18.9 L) capacity	Class I
- Noncombustible liquids or semiliquids (such as ketchup) in plastic containers with nominal wall thickness of ¼ in. (6.4 mm) or less and larger than 5 gal (18.9) capacity	Class II
- Noncombustible liquids or semiliquids (such as ketchup) in plastic containers with nominal wall thickness greater than ¼ in. (6.4 mm) and larger than 5 gal (18.9 L) capacity	Group A plastics
Polyurethane	
- Cartoned or uncartoned expanded	Group A plastics
Poultry Products	
- Canned, cartoned	Class I

**Table A.5.6.3 Alphabetized Listing of
Commodity Classes**

Commodity	Commodity Class
- Frozen, nonwaxed, nonplastic containers	Class I
- Frozen (on paper or expanded plastic trays)	Class II
Powders	
Ordinary combustibles — free flowing	
- In paper bags (e.g., flour, sugar)	Class II
PVA (polyvinyl alcohol) Resins	
PVC (polyvinyl chloride)	
- Flexible (e.g., cable jackets, plasticized sheets)	Class III
- Rigid (e.g., pipe, pipe fittings)	Class III
- Bagged resins	Class III
Rags	
Baled	
- Natural fibers	Class III
- Synthetic fibers	Class IV
Rubber	
- Natural, blocks in cartons	Class IV
- Synthetic	Group A plastics
Salt	
- Bagged	Class I
- Packaged, cartoned	Class II
Shingles	
- Asphalt-coated fiberglass	Class III
- Asphalt-impregnated felt	Class IV
Shock Absorbers	
- Metal dust cover	Class II
- Plastic dust cover	Class III
Signatures	
Books, magazines	
- Solid array on pallet	Class II
Skis	
- Wood	Class III
- Foam core	Class IV
Stuffed Toys	
Foam or synthetic	Group A plastics
Syrup	
- Drummed (metal containers)	Class I
- Barreled, wood	Class II
Textiles	

**Table A.5.6.3 Alphabetized Listing of
Commodity Classes**

Commodity	Commodity Class
Natural fiber clothing or textile products	Class III
Synthetics (except rayon and nylon) — 50/50 blend or less	
- Thread, yarn on wood or paper spools	Class III
- Fabrics	Class III
- Thread, yarn on plastic spools	Class IV
- Baled fiber	Group A plastics
Synthetics (except rayon and nylon) — greater than 50/50 blend	
- Thread, yarn on wood or paper spools	Class IV
- Fabrics	Class IV
- Baled fiber	Group A plastics
- Thread, yarn on plastic spools	Group A plastics
Rayon and nylon	
- Baled fiber	Class IV
- Thread, yarn on wood or paper spools	Class IV
- Fabrics	Class IV
- Thread, yarn on plastic spools	Group A plastics
Tobacco Products	
In paperboard cartons	Class III
Transformers	
Dry and oil filled	Class I
Vinyl-Coated Fabric	
Cartoned	Group A plastics
Vinyl Floor Coverings	
- Tiles in cartons	Class IV
- Rolled	Group A plastics
Wax-Coated Paper	
Cups, plates	
- Boxed or packaged inside cartons (emphasis on packaging)	Class IV
- Loose inside large cartons	Group A plastics
Wax	
Paraffin/petroleum wax, blocks, cartoned	Group A plastics
Wire	

**Table A.5.6.3 Alphabetized Listing of
Commodity Classes**

Commodity	Commodity Class
- Bare wire on metal spools on wood skids	Class I
- Bare wire on wood or cardboard spools on wood skids	Class II
- Bare wire on metal, wood, or cardboard spools in cardboard boxes on wood skids	Class II
- Single- or multiple-layer PVC-covered wire on metal spools on wood skids	Class II
- Insulated (PVC) cable on large wood or metal spools on wood skids	Class II
- Bare wire on plastic spools in cardboard boxes on wood skids	Class IV
- Single- or multiple-layer PVC-covered wire on plastic spools in cardboard boxes on wood skids	Class IV
- Single, multiple, or power cables (PVC) on large plastic spools	Class IV
- Bulk storage of empty plastic spools	Group A plastics
Wood Products	
- Solid piles — lumber, plywood, particleboard, pressboard (smooth ends and edges)	Class II
- Spools (empty)	Class III
- Toothpicks, clothespins, hangers in cartons	Class III
- Doors, windows, wood cabinets, and furniture	Class III
- Patterns	Class IV

**Table A.5.6.3 Alphabetized Listing of
Commodity Classes**

Commodity	Commodity Class
^a The product is presumed to be in a plastic-coated package in a corrugated carton. If packaged in a metal foil, it can be considered Class I.	
^b Most batteries have a polypropylene case and, if stored empty, should be treated as a Group A plastic. Truck batteries, even where filled, should be considered a Group A plastic because of their thicker walls.	
^c As the openings in plastic crates become larger, the product behaves more like a Class III commodity. Conversely, as the openings become smaller, the product behaves more like a plastic.	
^d These items should be treated as idle pallets.	
^e Tests clearly indicate that a synthetic or synthetic blend is considered greater than Class III.	
^f When liquor is stored in glass containers in racks, it should be considered a Class III commodity; where it is palletized, it should be considered a Class IV commodity.	

A.5.6.3.1 See Table A.5.6.3.1.

Table A.5.6.3.1 Examples of Class I Commodities

Alcoholic Beverages
 Cartoned or uncartoned
 - Up to 20 percent alcohol in metal, glass, or ceramic containers
 Appliances, Major (e.g., stoves, refrigerators)
 - Not packaged, no appreciable plastic exterior trim
 Batteries
 Dry cells (nonlithium or similar exotic metals)
 - Packaged in cartons
 Automobile
 - Filled*
 Bottles, Jars
 Empty, cartoned
 - Glass
 Filled noncombustible liquids
 - Glass, cartoned
 - Plastic, cartoned [less than 5 gal (18.9 L)]
 - Plastic, PET
 Filled noncombustible powders
 Copyright NFPA

- Glass, cartoned

Canned Foods

In ordinary cartons

Cans

Metal

- Empty

Cement

Bagged

Coffee

Canned, cartoned

Fertilizers

Bagged

- Phosphates

File Cabinets

Metal

- Cardboard box or shroud

Fish or Fish Products

Frozen

- Nonwaxed, nonplastic packaging

Canned

- Cartoned

Frozen Foods

Nonwaxed, nonplastic packaging

Fruit

Fresh

- Nonplastic trays or containers

- With wood spacers

Ice Cream

Meat, Meat Products

- Bulk

- Canned, cartoned

- Frozen, nonwaxed, nonplastic containers

Metal Desks

- With plastic tops and trim

Milk

- Nonwaxed-paper containers

- Waxed-paper containers

- Plastic containers

Motors

- Electric

Nuts

- Canned, cartoned

Paints

Friction-top cans, cartoned

- Water-based (latex)

Plastic Containers

- Noncombustible liquids or semiliquids in plastic containers less than 5 gal (18.9 L) capacity

Copyright NFPA

Poultry Products
- Canned, cartoned
- Frozen, nonwaxed, nonplastic containers
Salt
Bagged
Syrup
Drummed (metal containers)
Transformers
Dry and oil filled
Wire
Bare wire on metal spools on wood skids

*Most batteries have a polypropylene case and, if stored empty, should be treated as a Group A plastic. Truck batteries, even where filled, should be considered a Group A plastic because of their thicker walls.

A.5.6.3.2 See Table A.5.6.3.2.

**Table A.5.6.3.2 Examples of Class II
Commodities**

Alcoholic Beverages
Up to 20 percent alcohol in wood containers
Appliances, Major (e.g., stoves)
Corrugated, cartoned (no appreciable plastic trim)
Baked Goods
Cookies, cakes, pies
- Frozen, packaged in cartons*
Batteries
Dry cells (nonlithium or similar exotic metals) in
blister pack in cartons
Bottles, Jars
Filled noncombustible powders
- Plastic PET
Boxes, Crates
Empty, wood, solid walls
Fertilizers
Bagged
- Nitrates
Fish or Fish Products
Frozen
- Waxed-paper containers, cartoned
- Boxed or barreled
Frozen Foods
Waxed-paper containers, cartoned
Leather Hides
Baled

Copyright NFPA

Light Fixtures

Nonplastic

- Cartoned

Marble

Artificial sinks, countertops

- Cartoned, crated

Meat, Meat Products

- Frozen, waxed-paper containers
- Frozen, expanded plastic trays

Pharmaceuticals

Pills, powders

- Glass bottles, cartoned

Nonflammable liquids

- Glass bottles, cartoned

Photographic Film

- Motion picture or bulk rolls of film in polycarbonate, polyethylene, or metal cans; polyethylene bagged in cardboard boxes

Plastic Containers

Noncombustible liquids or semiliquids (such as ketchup) in plastic containers with nominal wall thickness of ¼ in. (6.4 mm) or less and larger than 5 gal (18.9 L) capacity

Poultry Products

Frozen (on paper or expanded plastic trays)

Powders (ordinary combustibles — free flowing)

In paper bags (e.g., flour, sugar)

Salt

Packaged, cartoned

Shock Absorbers

Metal dust cover

Signatures

Book, magazines

- Solid array on pallet

Syrup

Barreled, wood

Wire

- Bare wire on wood or cardboard spools on wood skids
- Bare wire on metal, wood, or cardboard spools in cardboard boxes on wood skids
- Single- or multiple-layer PVC-covered wire on metal spools on wood skids
- Insulated (PVC) cable on large wood or metal spools on wood skids

Wood Products

Solid piles

- Lumber, plywood, particle board, pressboard (smooth ends and edges)

Copyright NFPA

*The product is in a plastic-coated package in a corrugated carton. If packaged in a metal foil, it can be considered Class I.

A.5.6.3.3 See Table A.5.6.3.3.

Table A.5.6.3.3 Examples of Class III Commodities

Aerosols
Cartoned or uncartoned
- Level 1
Baked Goods
Cookies, cakes, pies
- Packaged, in cartons
Beans
Dried
- Packaged, cartoned
Bread
Wrapped, cartoned
Butter
Whipped spread
Candy
Packaged, cartoned
Cartons
Corrugated
- Unassembled (neat piles)
Cereals
Packaged, cartoned
Charcoal
Bagged
- Standard
Cheese
- Packaged, cartoned
- Wheels, cartoned
Chewing Gum
Packaged, cartoned
Chocolate
Packaged, cartoned
Cloth
Cartoned and not cartoned
- Natural fiber, viscose
Cocoa Products
Packaged, cartoned
Coffee
Packaged, cartoned
Coffee Beans

Copyright NFPA

Bagged
Cotton
Packaged, cartoned
Diapers
Cotton, linen
Dried Foods
Packaged, cartoned
Fish or Fish Products
Frozen
- Plastic trays, cartoned
Frozen Foods
Plastic trays
Furniture
Wood
- No plastic coverings or foam plastic cushioning
Grains — Packaged in Cartons
- Barley
- Rice
- Oats
Margarine
Up to 50 percent oil (in paper or plastic containers)
Mattresses
Standard (box spring)
Nuts
- Packaged, cartoned
- Bagged
Paper Products
Books, magazines, stationery, plastic-coated paper
food containers, newspapers, cardboard games,
cartoned tissue products
Paper, Rolled
In racks or on side
- Medium or heavyweight
Photographic Film
- 35 mm in metal film cartridges in polyethylene
cans in cardboard boxes
- Paper, in sheets, bagged in polyethylene, in
cardboard boxes
PVC (polyvinyl chloride)
- Flexible (e.g., cable jackets, plasticized sheets)
- Rigid (e.g., pipe, pipe fittings)
- Bagged resins
Rags
Baled
- Natural fibers
Shingles
Asphalt-coated fiberglass
Shock Absorbers

Copyright NFPA

Plastic dust cover
Skis
Wood
Textiles
Natural fiber clothing or textile products
Synthetics (except rayon and nylon) —
50/50 blend or less
- Thread, yarn on wood or paper spools
- Fabrics
Tobacco Products
In paperboard cartons
Wood Products
- Spools (empty)
- Toothpicks, clothespins, hangers in cartons
- Doors, windows, wood cabinets, and furniture

A.5.6.3.4 See Table A.5.6.3.4.

**Table A.5.6.3.4 Examples of Class IV
Commodities**

Ammunition
Small arms, shotgun
- Packaged, cartoned
Bottles, Jars
Empty, cartoned
- Plastic PET (polyethylene terephthalate)
Filled noncombustible powders
- Plastic, cartoned [less than 1 gal (3.8 L)]
Cartons
Corrugated
- Partially assembled
Cloth
Cartoned and not cartoned
- Synthetic^a
Diapers
Disposable with plastics and nonwoven fabric (in
cartons)
Fiberglass Insulation
- Paper-backed rolls, bagged or unbagged
Furniture
Wood
- With plastic coverings
Liquor
100 proof or less, 1 gal (3.8 L) or less, cartoned
- Glass (palletized)^b
- Plastic bottles

Copyright NFPA

Matches

Packaged, cartoned

- Paper

Nail Polish

1 oz to 2 oz (29.6 ml to 59.1 ml) glass, cartoned

Paints

Friction-top cans, cartoned

- Oil based

Paper, Rolled

In racks

- Lightweight

Paper, Waxed

Packaged in cartons

Pharmaceuticals

Pills, powders

- Plastic bottles, cartoned

Photographic Film

- Rolls in polycarbonate plastic cassettes, bulk wrapped in cardboard boxes

PVA (polyvinyl alcohol) Resins

Bagged

Rags

Baled

- Synthetic fibers

Rubber

Natural, blocks in cartons

Shingles

Asphalt-impregnated felt

Skis

Foam core

Textiles

Synthetics (except rayon and nylon) —

50/50 blend or less

- Thread, yarn on plastic spools

Synthetics (except rayon and nylon) — greater than 50/50 blend

- Thread, yarn on wood or paper spools

- Fabrics

Rayon and nylon

- Baled fiber

- Thread, yarn on wood or paper spools

- Fabrics

Vinyl Floor Coverings

Tiles in cartons

Wax-Coated Paper

Cups, plates

- Boxed or packaged inside cartons (emphasis is on packaging)

Copyright NFPA

Wire

- Bare wire on plastic spools in cardboard boxes on wood skids
- Single- or multiple-layer PVC-covered wire on plastic spools in cardboard boxes on wood skids
- Single, multiple, or power cables (PVC) on large plastic spools

Wood Products

Patterns

^a Tests clearly indicate that a synthetic or synthetic blend is considered greater than Class III.

^b Where liquor is stored in glass containers in racks, it should be considered a Class III commodity; where it is palletized, it should be considered a Class IV commodity.

A.5.6.4 The categories listed in 5.6.4.1, 5.6.4.2, and 5.6.4.3 are based on unmodified plastic materials. The use of fire- or flame-retarding modifiers or the physical form of the material could change the classification.

A.5.6.4.1 See Table A.5.6.4.1.

Table A.5.6.4.1 Examples of Group A Plastic Commodities

Batteries

Truck or larger

- Empty or filled^a

Bottles, Jars

Empty, cartoned

- Plastic (other than PET), any size

Filled noncombustible liquids

- Plastic, open or solid plastic crates^b

Filled noncombustible powders

- Plastic, cartoned or uncartoned [greater than 1 gal (3.8 L)]

- Plastic, solid plastic crates

- Plastic, open plastic crates

Candles

Packaged, cartoned

- Treat as expanded plastic

Carpet Tiles

Cartoned

Cartons

Wax coated, single walled

Diapers

-
Disposable with plastics and nonwoven fabric
(uncartoned), plastic wrapped

Furniture

Wood

- With foam plastic cushioning

Lighters

Butane

- Blister-packed, cartoned

Margarine

Between 50 percent and 80 percent oil (in any
packaging)

Matches

Packaged, cartoned

- Wood

Mattresses

Foam (in finished form)

Milk

Containers in plastic crates

Nail Polish

1 oz to 2 oz (29.6 ml to 59.1 ml) plastic bottles,
cartoned

Paper Products

Tissue products, uncartoned and plastic wrapped

Plastic Containers

- Combustible or noncombustible solids in plastic
containers and empty plastic containers

- Noncombustible liquids or semiliquids (such as
ketchup) in plastic containers with nominal wall
thickness greater than ¼ in. (6.4 mm) and larger
than 5 gal (18.9 L) capacity

Polyurethane

Cartoned or uncartoned expanded

Rubber

Synthetic

Stuffed Toys

Foam or synthetic

Textiles

Synthetics (except rayon and nylon) —
50/50 blend or less

- Baled fiber

Synthetics (except rayon and nylon) — greater
than 50/50 blend

- Baled fiber

- Thread, yarn on plastic spools

Rayon and nylon

- Thread, yarn on plastic spools

Vinyl-Coated Fabric

Cartoned

Vinyl Floor Coverings

Copyright NFPA

Rolled
Wax-Coated Paper
Cups, plates
- Loose inside large cartons
Wax
Paraffin/petroleum wax, blocks, cartoned
Wire
Bulk storage of empty plastic spools

^a Most batteries have a polypropylene case and, if stored empty, should be treated as a Group A plastic. Truck batteries, even when filled, should be considered a Group A plastic because of their thicker walls.

^b As the openings in plastic crates become larger, the product behaves more like Class III. Conversely, as the openings become smaller, the product makeup behaves more like a plastic.

A.5.6.5 Paper Classification. These classifications were derived from a series of large-scale and laboratory-type small-scale fire tests. It is recognized that not all paper in a class burns with exactly the same characteristics.

Paper can be soft or hard, thick or thin, or heavy or light and can also be coated with various materials. The broad range of papers can be classified according to various properties. One important property is basis weight, which is defined as the weight of a sheet of paper of a specified area. Two broad categories are recognized by industry — paper and paperboard. Paperboard normally has a basis weight of 20 lb (9.1 kg) or greater measured on a 1000 ft² (92.9 m²) sheet. Stock with a basis weight less than 20 lb/1000 ft² (9.1 kg/92.9 m²) is normally categorized as paper. The basis weight of paper is usually measured on a 3000 ft² (278.7 m²) sheet. The basis weight of paper can also be measured on the total area of a ream of paper, which is normally the case for the following types of printing and writing papers:

- (1) *Bond paper* — 500 sheets, 17 in. × 22 in. (432 mm × 559 mm) = 1300 ft² (120.8 m²) per ream
- (2) *Book paper* — 500 sheets, 25 in. × 38 in. (635 mm × 965 mm) = 3300 ft² (306.6 m²) per ream
- (3) *Index paper* — 500 sheets, 25½ in. × 30½ in. (648 mm × 775 mm) = 2700 ft² (250.8 m²) per ream
- (4) *Bristol paper* — 500 sheets, 22½ in. × 35 in. (572 mm × 889 mm) = 2734 ft² (254 m²) per ream
- (5) *Tag paper* — 500 sheets, 24 in. × 36 in. (610 mm × 914 mm) = 3000 ft² (278.7 m²) per ream

For the purposes of this standard, all basis weights are expressed in lb/1000 ft² (kg/92.9 m²) of paper. To determine the basis weight per 1000 ft² (92.9 m²) for papers measured on a

Copyright NFPA

sheet of different area, the following formula should be applied:

$$\frac{\text{Base weight}}{1000 \text{ ft}^2} = \text{basis weight} \times 1000 \text{ measured area}$$

Example: To determine the basis weight per 1000 ft² (92.9 m²) of 16 lb (7.3 kg) bond paper:

$$\left(\frac{16 \text{ lb}}{1300 \text{ ft}^2} \right) 1000 = \frac{12.3 \text{ lb}}{1000 \text{ ft}^2}$$

Large- and small-scale fire tests indicate that the burning rate of paper varies with the basis weight. Heavyweight paper burns more slowly than lightweight paper. Full-scale roll paper fire tests were conducted with the following types of paper:

- (1) *Linerboard* — 42 lb/1000 ft² (19.1 kg/92.9 m²) nominal basis weight
- (2) *Newsprint* — 10 lb/1000 ft² (4.5 kg/92.9 m²) nominal basis weight
- (3) *Tissue* — 5 lb/1000 ft² (2.3 kg/92.9 m²) nominal basis weight

The rate of firespread over the surface of the tissue rolls was extremely rapid in the full-scale fire tests. The rate of firespread over the surface of the linerboard rolls was slower. Based on the overall results of these full-scale tests, along with additional data from small-scale testing of various paper grades, the broad range of papers has been classified into three major categories as follows:

- (1) *Heavyweight* — Basis weight of 20 lb/1000 ft² (9.1 kg/ 92.9 m²) or greater
- (2) *Mediumweight* — Basis weight of 10 lb to 20 lb/1000 ft² (4.5 kg to 9.1 kg/92.9 m²)
- (3) *Lightweight* — Basis weight of less than 10 lb/1000 ft² (4.5 kg/92.9 m²) and tissues regardless of basis weight

The following SI units were used for conversion of English units:

- 1 lb = 0.454 kg
- 1 in. = 25.4 mm
- 1 ft = 0.3048 m
- 1 ft² = 0.0929 m²

The various types of papers normally found in each of the four major categories are provided in Table A.5.6.5.

Table A.5.6.5 Paper Classification

Heavyweight	Mediumweight	Lightweight	Tissue
Linerboards	Bond and reproduction	Carbonizing tissue	Toilet tissue
Medium Kraft roll wrappers	Vellum	Cigarette	Towel tissue
Milk carton board	Offset Tablet	Fruit wrap	
		Onion skin	

Table A.5.6.5 Paper Classification

Heavyweight	Mediumweight	Lightweight	Tissue
Folding carton board	Computer		
Bristol board	Envelope		
Tag	Book		
Vellum bristol board	Label		
Index	Magazine		
Cupstock	Butcher		
Pulp board	Bag		
	Newsprint (unwrapped)		

A.6.1.1 Included among items requiring listing are sprinklers, some pipe and some fittings, hangers, alarm devices, valves controlling flow of water to sprinklers, valve tamper switches, electrically operated solenoid valves, and gauges.

A.6.2.2 The four- to six-character sprinkler identification number, with no intervening spaces, is intended to identify the sprinkler operating characteristics in lieu of the traditional laboratory approval marking (e.g., SSU, SSP, EC, QR, etc.). The number, marked on the deflector of most sprinklers and elsewhere on decorative ceiling sprinklers, consists of one or two characters identifying the manufacturer, followed by three or four digits.

Sprinkler manufacturers have identified their manufacturer designations for the listing organizations. Each change in orifice size, response characteristics, or deflector (distribution) characteristics results in a new sprinkler identification number. The numbers do not identify specific characteristics of sprinklers but can be referenced in the database information compiled by the listing organizations. At the plan review stage, the sprinkler identification number should be checked against such a database or the manufacturer's literature to ensure that sprinklers are being used properly and within the limitations of their listings. Field inspections can include spot checks to ensure that the model numbers on the plans are those actually installed.

A.6.2.3.1 See Table A.6.2.3.1.

Table A.6.2.3.1 Nominal Sprinkler Orifice Sizes

Nominal K-factor		Nominal Orifice Size	
U.S.	metric	in.	mm
1.4	20	¼	6.4
1.9	27	$\frac{5}{16}$	8.0
2.8	40	$\frac{3}{8}$	9.5
4.2	60	$\frac{7}{16}$	11.0
5.6	80	½	12.7

Table A.6.2.3.1 Nominal Sprinkler Orifice Sizes

Nominal K-factor		Nominal Orifice Size	
U.S.	metric	in.	mm
8.0	115	$\frac{17}{32}$	13.5
11.2	161	$\frac{5}{8}$	15.9
14.0	201	$\frac{3}{4}$	19.0
16.8	242	—	—
19.6	497	—	—
22.4	322	—	—
25.2	363	—	—
28.0	403	—	—

A.6.2.5 Information regarding the highest temperature that can be encountered in any location in a particular installation can be obtained by use of a thermometer that will register the highest temperature encountered; it should be hung for several days in the location in question, with the plant in operation.

A.6.2.6.1 Examples of such locations include the following:

- (1) Paper mills
- (2) Packing houses
- (3) Tanneries
- (4) Alkali plants
- (5) Organic fertilizer plants
- (6) Foundries
- (7) Forge shops
- (8) Fumigation, pickle, and vinegar works
- (9) Stables
- (10) Storage battery rooms
- (11) Electroplating rooms
- (12) Galvanizing rooms
- (13) Steam rooms of all descriptions, including moist vapor dry kilns
- (14) Salt storage rooms
- (15) Locomotive sheds or houses
- (16) Driveways
- (17) Areas exposed to outside weather, such as piers and wharves exposed to salt air

- (18) Areas under sidewalks
- (19) Areas around bleaching equipment in flour mills
- (20) All portions of cold storage buildings where a direct ammonia expansion system is used
- (21) Portions of any plant where corrosive vapors prevail
- (22) Area over and around swimming pools, chlorine storage rooms, and pool pump rooms

A.6.2.6.1.2 Care should be taken in the handling and installation of wax-coated or similar sprinklers to avoid damaging the coating.

A.6.2.6.2 Painting of sprinklers can retard the thermal response of the heat-responsive element, can interfere with the free movement of parts, and can render the sprinkler inoperative. Moreover, painting can invite the application of subsequent coatings, thus increasing the possibility of a malfunction of the sprinkler.

A.6.2.7.2 The use of the wrong type of escutcheon with recessed or flush-type sprinklers can result in severe disruption of the spray pattern, which can destroy the effectiveness of the sprinkler.

A.6.2.9.1 A minimum of two sprinklers of each type and temperature rating should be provided.

A.6.2.9.7.1 The minimum information in the list contained in the spare sprinkler cabinet should be marked with the sprinkler identification described in 6.2.1, a general description of the sprinkler, including upright, pendent, residential, ESFR, etc., and the quantity of sprinklers that is to be maintained in the spare sprinkler cabinet.

An example of the list is shown in Figure A.6.2.9.7.1.

Sprinklers Contained in this Cabinet			
Sprinkler Identification, SIN	General Description	Temperature Rating, °F	Sprinkler Quantity Maintained
TY9128	Extended Coverage, k=25, upright	155	6
VK425	Concealed pendent residential	145	6

Issued: 10/3/05 Revised:

FIGURE A.6.2.9.7.1 Sample List.

A.6.3.2 See Table A.6.3.2.

Table A.6.3.2 Steel Pipe Dimens

--	--	--	--

FIGURE A.6.2.9.7.1 Sample List.

A.6.3.2 See Table A.6.3.2.

Table A.6.3.2 Steel Pipe Dimens

Nominal Pipe Size		Schedule 5						Schedule 10 ^a			
		Outside Diameter		Inside Diameter		Wall Thickness		Inside Diameter		Wall Thickness	
in.	mm	in.	mm	in.	mm	in.	mm	in.	mm	in.	mm
½ ^b	15	0.840	21.3	—	—	—	—	0.674	17.0	0.083	2.1
¾ ^b	20	1.050	26.7	—	—	—	—	0.884	22.4	0.083	2.1
1	25	1.315	33.4	1.185	30.1	0.065	1.7	1.097	27.9	0.109	2.8
1¼	32	1.660	42.2	1.530	38.9	0.065	1.7	1.442	36.6	0.109	2.8
1½	40	1.900	48.3	1.770	45.0	0.065	1.7	1.682	42.7	0.109	2.8
2	50	2.375	60.3	2.245	57.0	0.065	1.7	2.157	54.8	0.109	2.8
2½	65	2.875	73.0	2.709	68.8	0.083	2.1	2.635	66.9	0.120	3.0
3	80	3.500	88.9	3.334	84.7	0.083	2.1	3.260	82.8	0.120	3.0
3½	90	4.000	101.6	3.834	97.4	0.083	2.1	3.760	95.5	0.120	3.0
4	100	4.500	114.3	4.334	110.1	0.083	2.1	4.260	108.2	0.120	3.0
5	125	5.563	141.3	—	—	—	—	5.295	134.5	0.134	3.4
6	150	6.625	168.3	6.407	162.7	0.109	2.8	6.357	161.5	0.134 ^c	3.4
8	200	8.625	219.1	—	—	—	—	8.249	209.5	0.188 ^c	4.8
10	250	10.750	273.1	—	—	—	—	10.370	263.4	0.188 ^c	4.8
12	300	12.750	—	—	—	—	—	—	—	—	—

^a Schedule 10 defined to 5 in. (127 mm) nominal pipe size by ASTM A 135, *Standard Specification for Elect*

^b These values applicable when used in conjunction with 8.14.19.3 and 8.14.19.4.

^c Wall thickness specified in 6.3.2.

^d Wall thickness specified in 6.3.3.

A.6.3.5 See Table A.6.3.5.

Table A.6.3.5 Copper Tube Dimensio

Nominal Tube Size		Type K							
		Outside Diameter		Inside Diameter		Wall Thickness		Inside Dian	
in.	mm	in.	mm	in.	mm	in.	mm	in.	n
¾	20	0.875	22.2	0.745	18.9	0.065	1.7	0.785	1'
1	25	1.125	28.6	0.995	25.3	0.065	1.7	1.025	2'
1¼	32	1.375	34.9	1.245	31.6	0.065	1.7	1.265	3'
1½	40	1.625	41.3	1.481	37.6	0.072	1.8	1.505	3'
2	50	2.125	54.0	1.959	49.8	0.083	2.1	1.985	5'
2½	65	2.625	66.7	2.435	61.8	0.095	2.4	2.465	6'
3	80	3.125	79.4	2.907	73.8	0.109	2.8	2.945	7'

Table A.6.3.5 Copper Tube Dimension

Nominal Tube Size		Type K							
		Outside Diameter		Inside Diameter		Wall Thickness		Inside Diameter	
in.	mm	in.	mm	in.	mm	in.	mm	in.	n
3½	90	3.625	92.1	3.385	86.0	0.120	3.0	3.425	8
4	100	4.125	104.8	3.857	98.0	0.134	3.4	3.905	9
5	125	5.125	130.2	4.805	122.0	0.160	4.1	4.875	12
6	150	6.125	155.6	5.741	145.8	0.192	4.9	5.845	14
8	200	8.125	206.4	7.583	192.6	0.271	6.9	7.725	19
10	250	10.130	257.3	9.449	240.0	0.338	8.6	9.625	24

A.6.3.6 Other types of pipe and tube that have been investigated and listed for sprinkler applications include lightweight steel pipe and thermoplastic pipe and fittings. While these products can offer advantages, such as ease of handling and installation, cost-effectiveness, reduction of friction losses, and improved corrosion resistance, it is important to recognize that they also have limitations that are to be considered by those contemplating their use or acceptance.

Corrosion studies have shown that, in comparison to Schedule 40 pipe, the effective life of lightweight steel pipe can be reduced, the level of reduction being related to its wall thickness. Further information with respect to corrosion resistance is contained in the individual listings for such pipe.

With respect to thermoplastic pipe and fittings, exposure of such piping to elevated temperatures in excess of that for which it has been listed can result in distortion or failure. Accordingly, care must be exercised when locating such systems to ensure that the ambient temperature, including seasonal variations, does not exceed the rated value.

The upper service temperature limit of currently listed CPVC sprinkler pipe is 150°F (65.5°C) at 175 psi (12.1 bar). The upper service temperature limit of currently listed polybutylene sprinkler pipe is 120°F (49°C) at 175 psi (12.1 bar).

Not all pipe or tube made to ASTM F 442, *Standard Specification for Chlorinated Poly (Vinyl Chloride) (CPVC) Plastic Pipe (SDR-PR)*, is listed for fire sprinkler service. Listed pipe is identified by the logo of the listing agency.

Not all fittings made to ASTM F 437, *Standard Specification for Threaded Chlorinated Poly (Vinyl Chloride) (CPVC) Plastic Pipe Fittings, Schedule 80*; ASTM F 438, *Standard Specification for Socket-Type Chlorinated Poly (Vinyl Chloride) (CPVC) Plastic Pipe Fittings, Schedule 40*; and ASTM F 439, *Standard Specification for Socket-Type Chlorinated Poly (Vinyl Chloride) (CPVC) Plastic Pipe Fittings, Schedule 80*, as described in 6.4.3, are listed for fire sprinkler service. Listed fittings are identified by the logo of the listing agency.

Consideration must also be given to the possibility of exposure of the piping to elevated temperatures during a fire. The survival of thermoplastic piping under fire conditions is

primarily due to the cooling effect of the discharge from the sprinklers it serves. As this discharge might not occur simultaneously with the rise in ambient temperature and, under some circumstances, can be delayed for periods beyond the tolerance of the piping, protection in the form of a fire-resistant membrane is generally required. (Some listings do provide for the use of exposed piping in conjunction with residential or quick-response sprinklers, but only under specific, limited installation criteria.)

Where protection is required, it is described in the listing information for each individual product, and the requirements given must be followed. It is equally important that such protection must be maintained. Removal of, for example, one or more panels in a lay-in ceiling can expose piping in the concealed space to the possibility of failure in the event of a fire. Similarly, the relocation of openings through protective ceilings that expose the pipe to heat, inconsistent with the listing, would place the system in jeopardy. The potential for loss of the protective membrane under earthquake conditions should also be considered.

While the listings of thermoplastic piping do not prohibit its installation in combustible concealed spaces where the provision of sprinkler protection is not required, and while the statistical record of fire originating in such spaces is low, it should be recognized that the occurrence of a fire in such a space could result in failure of the piping system.

The investigation of pipe and tube other than described in Table 6.3.1.1 should involve consideration of many factors, including the following:

- (1) Pressure rating
- (2) Beam strength (hangers)
- (3) Unsupported vertical stability
- (4) Movement during sprinkler operation (affecting water distribution)
- (5) Corrosion (internal and external), chemical and electrolytic
- (6) Resistance to failure when exposed to elevated temperatures
- (7) Methods of joining (strength, permanence, fire hazard)
- (8) Physical characteristics related to integrity during earthquakes

A.6.4.3 Rubber-gasketed pipe fittings and couplings should not be installed where ambient temperatures can be expected to exceed 150°F (66°C) unless listed for this service. If the manufacturer further limits a given gasket compound, those recommendations should be followed.

A.6.4.4 The rupture strength of cast-iron fittings 2 in. (50.8 mm) in size and smaller and malleable iron fittings 6 in. (152.4 mm) in size and smaller is sufficient to provide an adequate factor of safety.

A.6.4.5 Listed flexible connections are permissible and encouraged for sprinkler installations in racks to reduce the possibility of physical damage. Where flexible tubing is used, it should be located so that it will be protected against mechanical injury.

A.6.5.1.2 Some steel piping material having lesser wall thickness than specified in 6.5.1.2

has been listed for use in sprinkler systems where joined with threaded connections. The service life of such products can be significantly less than that of Schedule 40 steel pipe, and it should be determined if this service life will be sufficient for the application intended.

All such threads should be checked by the installer using working ring gauges conforming to the “Basic Dimensions of Ring Gauges for USA (American) Standard Taper Pipe Threads, NPT,” as per Table 8 of ASME B1.20.1, *Pipe Threads, General Purpose (Inch)*.

A.6.5.2.2 Cutting and welding operations account for 4 percent of fires each year in nonresidential properties and 8 percent in industrial and manufacturing properties. In-place welding of sprinkler piping introduces a significant hazard that can normally be avoided by shop-welding the piping and installing the welded sections with mechanical fittings. As a result, the standard requires that all piping be shop-welded. When such situations cannot be avoided, the exceptions outline procedures and practices that minimize the increase in hazard. (See Figure A.6.5.2.2.)

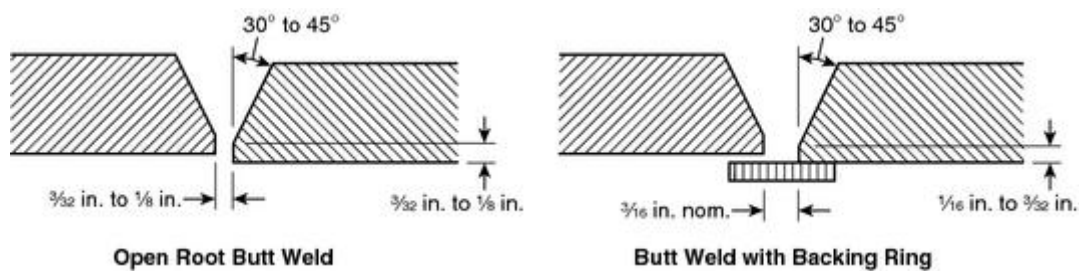

FIGURE A.6.5.2.2 Weld Diagram.

A.6.5.2.3.1 Listed, shaped, and contoured nipples meet the definition of fabricated fittings.

A.6.5.2.4.1 Partial penetration welds on outlet fitting connections are considered adequate, since there is no significant load on the joint other than that caused by pressure internal to the pipe (see Figure A.6.5.2.4.1). The load due to the internal pressure can be accommodated with a weld that has a conservative weld throat thickness that can be calculated as follows:

$$\text{Weld throat thickness (in.)} = PD \times 0.000035$$

where:

P = rated system pressure (psig)

D = Outside diameter of the fitting (in.)

For example: If you assume a pressure of 300 psig and the OD of the outlet fitting of 3 in., the result of the thickness calculation is 0.0315 in. When compared to the minimum throat thickness of $\frac{3}{16}$ in. (0.18 in.), there is a factor of more than 5 times the calculated thickness value.

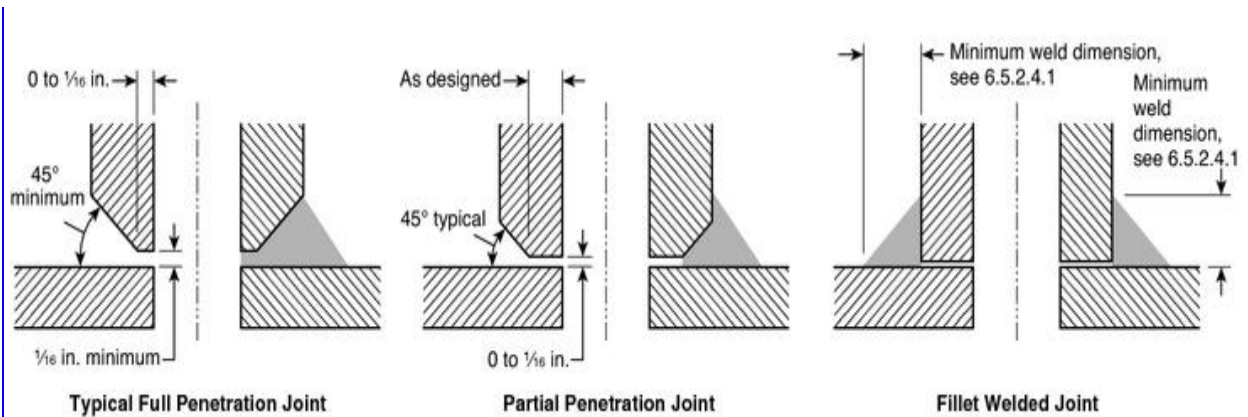

FIGURE A.6.5.2.4.1 Weld Descriptions.

A.6.5.2.4.2 The preparation of mating surfaces is important to the proper fabrication of a weld joint. To accomplish this, the mating surfaces should be prepared and configured so that a full penetration weld is achievable, but a partial penetration weld is acceptable.

A.6.5.4 The fire hazard of the brazing and soldering processes should be suitably safeguarded.

A.6.5.4.5 Soldering fluxes manufactured to the specifications required by Table 6.3.1.1 are unlikely to cause damage to the seats of sprinklers. When brazing flux is used, it must be of a type not likely to damage the seats of sprinklers.

A.6.6 See Section 9.1 for information pertaining to the type of hangers and hanger components acceptable for use on a sprinkler system.

A.6.7.4 The intent of 6.7.4 is to provide assistance in determining the area of a building served by a particular control valve.

A.6.7.4.3.1 Care should be taken to ensure that all water supplies are isolated before work begins. Work on systems by shutting one valve and not knowing about another valve could result in unexpected water discharge.

A.6.8.1 The purpose of the fire department connection is to supplement the water supply but not necessarily provide the entire sprinkler system demand. Fire department connections are not intended to deliver a specific volume of water.

A.6.9.2.4 The surge of water that occurs when the valve trips can seriously damage the device. Paddle-type waterflow devices are also permitted to be installed on wet systems that supply auxiliary dry pipe and/or preaction systems.

A.6.9.3.1 Audible alarms are normally located on the outside of the building. Listed electric gongs, bells, horns, or sirens inside the building, or a combination of such used inside and outside, are sometimes advisable.

Outside alarms can be omitted where the sprinkler system is used as part of a central station; auxiliary, remote station, or proprietary signaling fire alarm system utilizing listed audible inside alarm devices.

A.6.9.3.2 All alarm apparatus should be so located and installed that all parts are accessible

for inspection, removal, and repair, and such apparatus should be substantially supported.

The water motor gong bell mechanism should be protected from weather-related elements such as rain, snow, or ice. To the extent practicable, it should also be protected from other influencing factors such as birds or other small animals that might attempt to nest in such a device.

A.6.9.4 Switches that will silence electric alarm-sounding devices by interruption of electric current are not desirable; however, if such means are provided, then the electric alarm-sounding device circuit should be arranged so that, when the sounding device is electrically silenced, that fact should be indicated by means of a conspicuous light located in the vicinity of the riser or alarm control panel. This light should remain in operation during the entire period of the electric circuit interruption.

A.7.2 A dry pipe system should be installed only where heat is not adequate to prevent freezing of water in all parts of, or in sections of, the system. Dry pipe systems should be converted to wet pipe systems when they become unnecessary because adequate heat is provided. Sprinklers should not be shut off in cold weather.

Where two or more dry pipe valves are used, systems preferably should be divided horizontally to prevent simultaneous operation of more than one system and the resultant increased time delay in filling systems and discharging water and to prevent receipt of more than one waterflow alarm signal.

Where adequate heat is present in sections of the dry pipe system, consideration should be given to dividing the system into a separate wet pipe system and dry pipe system. Minimized use of dry pipe systems is desirable where speed of operation is of particular concern.

A.7.2.2(2) Installation limitations of listed dry pendent sprinklers can vary with different products. Limitations should be included in product installation instructions to warn the user of the potential accumulation of water, scale, and sediment from collecting at the sprinkler.

A.7.2.3 The capacities of the various sizes of pipe given in Table A.7.2.3 are for convenience in calculating the capacity of a system.

Table A.7.2.3 Capacity of 1 ft of Pipe (Based on Actual Internal Pipe)

Nominal Pipe Diameter		Pipe		Nominal Pipe Diameter	
in.	mm	Schedule 40 (gal)	Schedule 10 (gal)	in.	mm
¾	20	0.028		3	80
1	25	0.045	0.049	3½	90
1¼	32	0.078	0.085	4	100
1½	40	0.106	0.115	5	125
2	50	0.174	0.190	6	150
2½	65	0.248	0.283	8	200

For SI units, 1 in. = 25.4 mm; 1 ft = 0.3048 m; 1 gal = 3.785 L.

^a Schedule 30.

^b 0.134 wall pipe.

^c 0.188 wall pipe.

A.7.2.3.1 The 60-second limit does not apply to dry systems with capacities of 500 gal (1893 L) or less, nor to dry systems with capacities of 750 gal (2839 L) or less if equipped with a quick-opening device.

A.7.2.3.7 See Figure A.7.2.3.7.

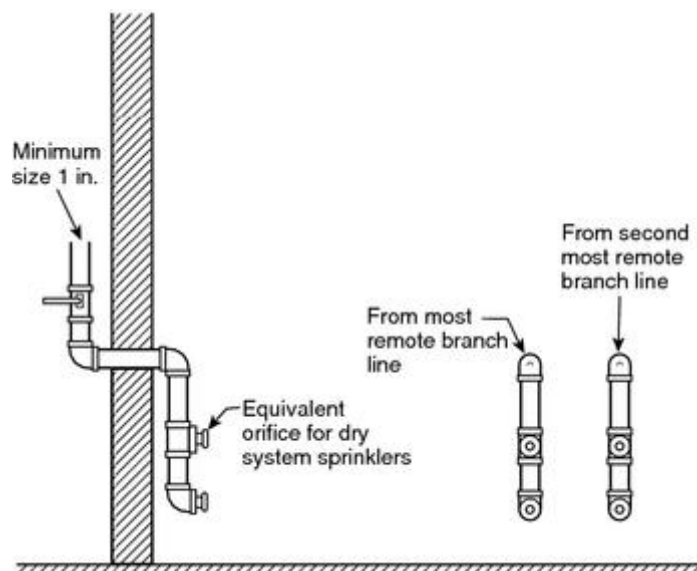

FIGURE A.7.2.3.7 Example Manifold Arrangement (Four Sprinklers).

A.7.2.5 The dry pipe valve should be located in an accessible place near the sprinkler system it controls. Where exposed to cold, the dry pipe valve should be located in a valve room or enclosure of adequate size to properly service equipment.

A.7.2.5.1 The dry pipe valve and supply piping should be in an area maintained at or above 40°F (4°C). It is the intent of the committee to protect the valves from freezing. The occasional exposure of valves to short exposures of air temperatures below 40°F (4°C) that would not cause the valves to freeze does not justify the construction of a valve room.

A.7.2.6.2 The compressor should draw its air supply from within the operating criteria allowed by the manufacturer of the compressor. Air piping should not be attached to the intake of the compressor unless acceptable to the compressor manufacturer and installed in accordance with 7.9.2.7. Damage, air reduction, or reduced life expectancy can result if guidelines are not followed.

A.7.2.6.2.2 When a single compressor serves multiple dry pipe systems, the 30-minute fill time is based on the single largest system.

A.7.3.1 Conditions of occupancy or special hazards might require quick application of large quantities of water, and, in such cases, deluge systems might be needed.

Fire detection devices should be selected to ensure operation yet guard against premature operation of sprinklers based on normal room temperatures and draft conditions.

In locations where ambient temperature at the ceiling is high from heat sources other than
Copyright NFPA

fire conditions, heat-responsive devices that operate at higher than ordinary temperature and that are capable of withstanding the normal high temperature for long periods of time should be selected.

Where corrosive conditions exist, materials or protective coatings that resist corrosion should be used.

To help avoid ice formation in piping due to accidental tripping of dry pipe valves in cold storage rooms, a deluge automatic water control valve can be used on the supply side of the dry pipe valve. Where this method is employed, the following also apply:

- (1) Dry systems can be manifolded to a deluge valve, with the protected area not exceeding 40,000 ft² (3716 m²).
- (2) Where a dry system is manifolded to a deluge valve, the distance between valves should be as short as possible to minimize water hammer.
- (3) The dry pipe valves should be pressurized to 50 psi (3.4 bar) to reduce the possibility of dry pipe valve operation from water hammer.

A.7.3.1.1 When using electrical operating methods to actuate preaction systems and deluge systems, care should be observed in selecting the solenoid valve. This valve must be compatible with the fire detection system, including its control panel, and the preaction or deluge valve. This often involves listing with both the preaction or deluge valve manufacturer and the fire detection system manufacturer. Information regarding solenoid compatibility is included in the releasing device (panel) installation instructions.

Small preaction and deluge systems with and without separate electrical-based detection and control panels have been installed prior to the introduction of the detection system requirements of *NFPA 72*. Pneumatic-based actuation using heat actuated devices (HADs), pneumatic line-type detection, and pilot sprinklers are examples of non-electric-based detectors and control devices. *NFPA 13* recognizes the use and installation of these types of systems and provides guidance in producing a reliable detection and suppression system combination. Remote manual operation of combined dry pipe and preaction systems is needed because of the often very long length dimension of such systems and the long travel time to reach the control valves. Such remote manual operation speeds water into the piping network.

A.7.3.2.4 Supervision, either electrical or mechanical, as used in 7.3.2.4 refers to constant monitoring of piping and detection equipment to ensure the integrity of the system. Detection devices of listed flow cycling assemblies that cause an alarm during a single open or a single ground fault condition should be considered to satisfy the supervision requirement.

A.7.3.2.5(2) See A.7.2.2(2).

A.7.3.3 Where 8 in. (203 mm) piping is employed to reduce friction losses in a system operated by fire detection devices, a 6 in. (152 mm) preaction or deluge valve and a 6 in. (152 mm) gate valve between tapered reducers should be permitted.

A.7.4.2 Systems described by Section 7.4 are special types of noninterlocking preaction

systems intended for use in, but not limited to, structures where a number of dry pipe valves would be required if a dry pipe system were installed. These systems are primarily used in piers and wharves.

A.7.4.2.1 See Figure A.7.4.2.1.

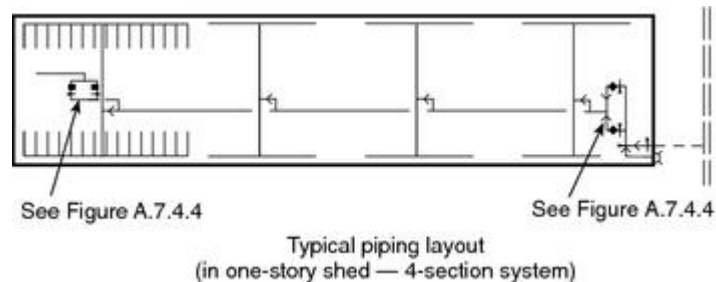

FIGURE A.7.4.2.1 Typical Piping Layout for Combined Dry Pipe and Preaction Sprinkler System.

A.7.4.2.4(2) See A.7.2.2(2).

A.7.4.4 See Figure A.7.4.4.

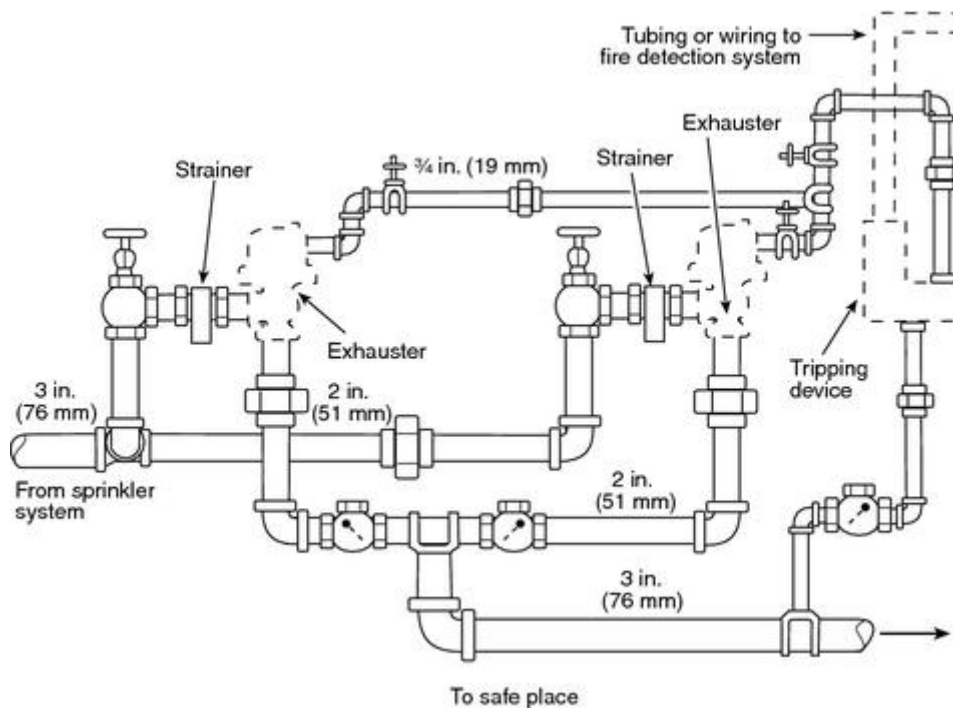

FIGURE A.7.4.4 Arrangement of Air Exhaust Valves for Combined Dry Pipe and Preaction Sprinkler System.

A.7.6.1 The definition of an antifreeze system states that water will discharge after the antifreeze leaves the pipes. Systems that are all antifreeze, including tanks of antifreeze solution that will not discharge plain water, are not true antifreeze systems. Such systems should not be used without consideration to issues such as the combustibility of the antifreeze solution and the friction loss in the piping during cold conditions.

A.7.6.2 Listed CPVC sprinkler pipe and fittings should be protected from freezing with glycerine only. The use of diethylene, ethylene, or propylene glycols is specifically prohibited. Laboratory testing shows that glycol-based antifreeze solutions present a chemical environment detrimental to CPVC.

The use of premixed antifreeze solutions is not required by this standard but may be required for certain specially listed equipment or systems. Thoroughly mixed antifreeze is less likely to drop out of solution. When antifreeze solutions are mixed on-site, the solution should be thoroughly mixed before being pumped into the piping. Prior to pumping solution that is mixed on-site into system piping, several samples should be tested from the batch to ensure that the concentration of the solution is uniform.

A.7.6.2.4 Beyond certain limits, an increased proportion of antifreeze does not lower the freezing point of solution (*see Figure A.7.6.2.4*).

Glycerine, diethylene glycol, ethylene glycol, and propylene glycol should never be used without mixing with water in proper proportions, because these materials tend to thicken near 32°F (0°C).

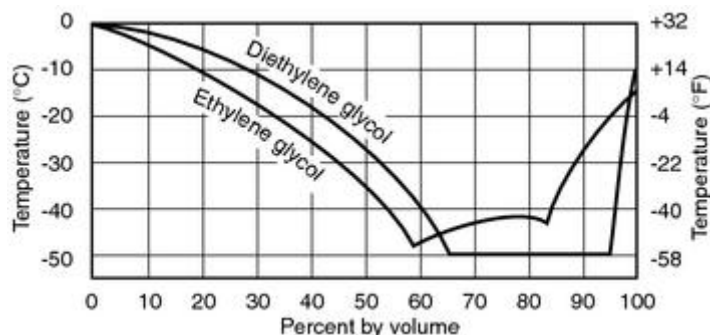

FIGURE A.7.6.2.4 Freezing Points of Water Solutions of Ethylene Glycol and Diethylene Glycol.

A.7.6.3.1 All permitted antifreeze solutions are heavier than water. At the point of contact (interface), the heavier liquid will be below the lighter liquid, preventing diffusion of water into the unheated areas.

A.7.6.3.2 One formula for sizing the chamber is as follows. Other methods also exist.

$$\Delta L = S_v \left(\frac{D_L}{D_H} - 1 \right)$$

where:

ΔL = change in antifreeze solution volume (gal) due to thermal expansion

S_v = volume (gal) of antifreeze system, not including the expansion chamber

D_L = density (gm/ml) of antifreeze solution at lowest expected temperature

D_H = density (gm/ml) of antifreeze solution at highest expected temperature

This method is based on the following information:

Copyright NFPA

$$\frac{P_0 \cdot V_0}{T_0} = \frac{P_1 \cdot V_1}{T_1} = \frac{P_2 \cdot V_2}{T_2}$$

where:

V_{EC} = minimum required volume (gal) of expansion chamber

V_0 = air volume (gal) in expansion chamber at precharge (before installation)

V_1 = air volume (gal) in expansion chamber at normal static pressure

V_2 = air volume (gal) in expansion chamber at post-expansion pressure (antifreeze at high temperature)

P_0 = absolute precharge pressure (psia) on expansion chamber before installation

P_1 = absolute static pressure (psi) on water (supply) side of backflow preventer

P_2 = absolute maximum allowable working pressure (psi) for antifreeze system

T_0 = temperature (°R) of air in expansion chamber at precharge

T_1 = temperature (°R) of air in expansion chamber when antifreeze system piping is at lowest expected temperature

T_2 = temperature (°R) of air in expansion chamber when antifreeze system piping is at highest expected temperature

This equation is one formulation of the ideal gas law from basic chemistry. The amount of air in the expansion chamber will not change over time. The pressure, temperature, and volume of the air at different times will be related in accordance with this formula:

$$V_2 = V_1 - \Delta L$$

The antifreeze in the system is essentially incompressible, so the air volume in the expansion chamber will decrease by an amount equal to the expansion of the antifreeze.

It is assumed that there is no trapped air in the system piping, so the only air in the system is in the expansion chamber. This is a conservative assumption, since more air is better. In reality, there will be at least some trapped air. However, only the air in the expansion chamber can be relied upon to be available when needed.

$$V_{EC} = V_0$$

At precharge, the chamber will be completely full of air.

$$V_{EC} = \frac{P_1 \cdot T_0 \cdot P_2 \cdot \Delta L \cdot T_1}{P_0 \cdot T_1 (P_2 \cdot T_1 - P_1 \cdot T_2)}$$

In cases where the normal static pressure on the sprinkler system is close to the maximum working pressure, antifreeze systems are not advisable if the connection to the wet pipe system will incorporate a backflow device. In these cases, expansion of the antifreeze solution during warm weather will cause the antifreeze system to exceed the maximum working pressure, regardless of the size of the expansion chamber. The normal static pressure is too close to the maximum working pressure if the preceding formula for V_{EC}

Copyright NFPA

yields a negative result. If this occurs, use a dry pipe system instead or install a pressure reducing valve before the backflow preventer.

A.7.6.3.5 Systems larger than 40 gal (151 L) are required by NFPA 25 to check the concentration levels at the supply inlet to the antifreeze system and at a remote point of the system.

A.7.7.1.2 Outlets should be provided at critical points on sprinkler system piping to accommodate attachment of pressure gauges for test purposes.

A.7.9 Careful installation and maintenance, and some special arrangements of piping and devices as outlined in this section, are needed to avoid the formation of ice and frost inside piping in cold storage rooms that will be maintained at or below 32°F (0°C). Conditions are particularly favorable to condensation where pipes enter cold rooms from rooms having temperatures above freezing.

Whenever the opportunity offers, fittings such as those specified in 7.9.2.1, as well as flushing connections, should be provided in existing systems.

Where possible, risers should be located in stair towers or other locations outside of refrigerated areas, which would reduce the probabilities of ice or frost formation within the riser (supply) pipe.

Cross mains should be connected to risers or feed mains with flanges. In general, flanged fittings should be installed at points that would allow easy dismantling of the system. Split ring or other easily removable types of hangers will facilitate the dismantling.

Because it is not practical to allow water to flow into sprinkler piping in spaces that might be constantly subject to freezing, or where temperatures must be maintained at or below 40°F (4.4°C), it is important that means be provided at the time of system installation to conduct trip tests on dry pipe valves that service such systems. NFPA 25, *Standard for the Inspection, Testing, and Maintenance of Water-Based Fire Protection Systems*, contains requirements in this matter.

A.7.9.2 The requirements in 7.9.2 are intended to minimize the chances of ice plug formation inside sprinkler system piping protecting freezers.

A.7.9.2.4 A higher degree of preventing the formation of ice blocks can be achieved by lowering the moisture of the air supply entering the refrigerated space to a pressure dew point no greater than 20°F (-6.6°C) below the lowest nominal temperature of the refrigerated space. The pressure dew point of the air supply can cause moisture to condense and freeze in sprinkler pipe even when the air supply is from the freezer. One method of reducing the moisture content of the air by use of air drying systems is illustrated in Figure A.7.9.2.4.

When compressors and dryers are used for an air supply, consideration should be given to pressure requirements of the regenerative dryers, compressor size, air pressure regulator capacity, and air fill rate. Application of these factors could necessitate the use of increased air pressures and a larger air compressor.

The compressed air supply should be properly prepared prior to entering a regenerative-type air dryer, such as minimum air pressure, maximum inlet air temperature, and proper filtration

of compressed air.

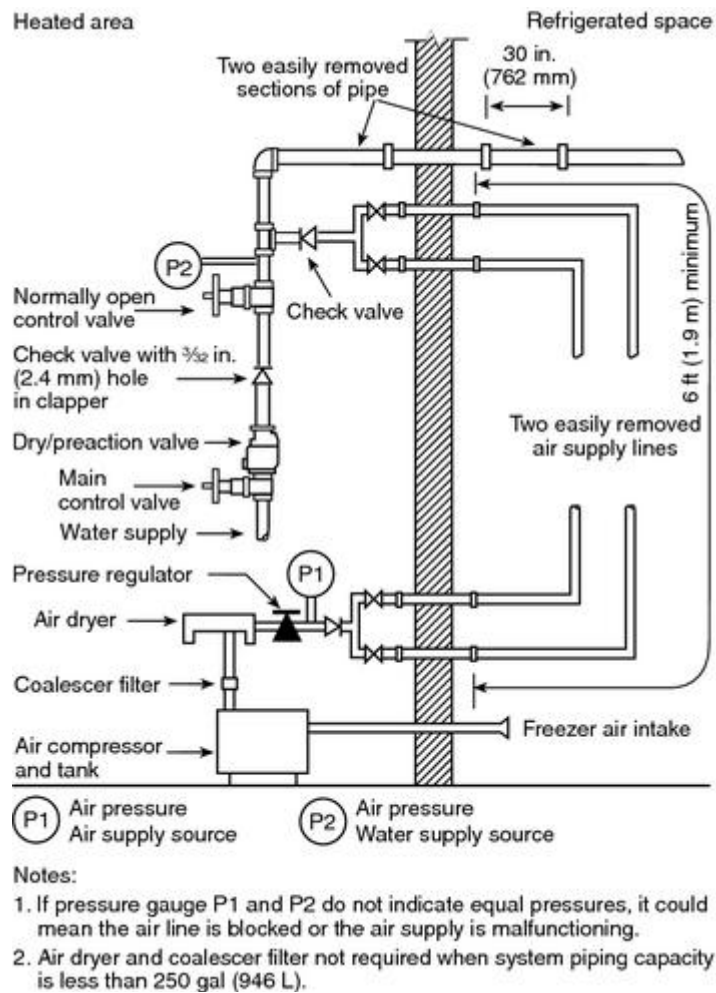

FIGURE A.7.9.2.4 Refrigerator Area Sprinkler Systems Used to Minimize the Chances of Developing Ice Plugs.

A.7.9.2.5 A major factor contributing to the introduction of moisture into the system piping is excessive air compressor operation caused by system leakage. Where excessive compressor operation is noted or ice accumulates in the air supply piping, the system should be checked for leakage and appropriate corrective action should be taken.

A.7.9.2.6 The purpose of the check valve is to prevent evaporation of prime water into the system piping.

A.7.9.2.7 The dual lines feeding the system air entering the cold area are intended to facilitate continued service of the system when one line is removed for inspection. It should be noted that, when using a system as described in Figure A.7.9.2.4, differences in the pressures at gauge P1 and gauge P2 indicate blockage in the air supply line or other malfunctions.

A.7.9.2.8.1.1 While it is the intent to require the detection system to operate prior to sprinklers, it is possible that in some fire scenarios the sprinklers could operate prior to the detection system. In general, the detection system, at its installed location and spacing,

Copyright NFPA

should be more sensitive to fire than the sprinklers.

A.7.10.2 See Figure A.7.10.2.

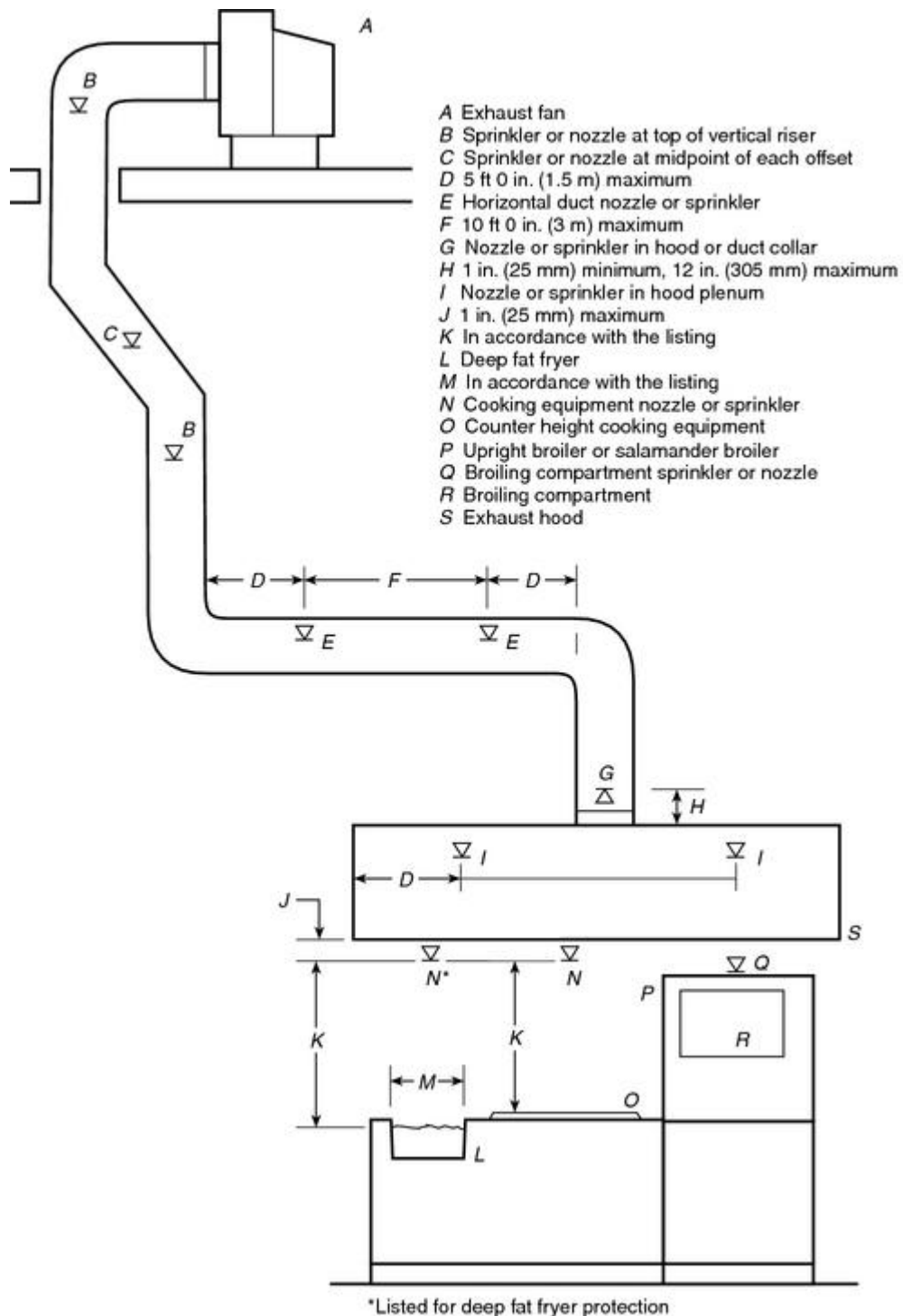

FIGURE A.7.10.2 Typical Installation Showing Automatic Sprinklers or Automatic Nozzles Being Used for the Protection of Commercial Cooking Equipment and Ventilation Systems.

A.8.1 The installation requirements are specific for the normal arrangement of structural
 Copyright NFPA

members. There will be arrangements of structural members not specifically detailed by the requirements. By applying the basic principles, layouts for such construction can vary from specific illustrations, provided the maximums specified for the spacing and location of sprinklers (Section 8.4) are not exceeded.

Where buildings or portions of buildings are of combustible construction or contain combustible material, standard fire barriers should be provided to separate the areas that are sprinkler protected from adjoining unsprinklered areas. All openings should be protected in accordance with applicable standards, and no sprinkler piping should be placed in an unsprinklered area unless the area is permitted to be unsprinklered by this standard.

Water supplies for partial systems should be designed with consideration to the fact that in a partial system more sprinklers might be opened in a fire that originates in an unprotected area and spreads to the sprinklered area than would be the case in a completely protected building. Fire originating in a nonsprinklered area might overpower the partial sprinkler system.

Where sprinklers are installed in corridors only, sprinklers should be spaced up to the maximum of 15 ft (4.5 m) along the corridor, with one sprinkler opposite the center of any door or pair of adjacent doors opening onto the corridor, and with an additional sprinkler installed inside each adjacent room above the door opening. Where the sprinkler in the adjacent room provides full protection for that space, an additional sprinkler is not required in the corridor adjacent to the door.

A.8.1.1 This standard contemplates full sprinkler protection for all areas including walk-in coolers, freezers, bank vaults, and similar areas. Other NFPA standards that mandate sprinkler installation might not require sprinklers in certain areas. Based upon experience and testing, sprinklers have been found to be effective and necessary at heights in excess of 50 ft (15.2 m). For a building to meet the intended level of protection afforded by NFPA 13, sprinklers must not be omitted from such high ceiling spaces. The requirements of this standard should be used insofar as they are applicable. The authority having jurisdiction should be consulted in each case. A building is considered sprinklered throughout when protected in accordance with the requirements of this standard.

A.8.1.2 The components need not be open or exposed. Doors, removable panels, or valve pits can satisfy this need. Such equipment should not be obstructed by such permanent features as walls, ducts, columns, or direct burial.

A.8.2.5 Buildings adjacent to a primary structure can be protected by extending the fire sprinkler system from the primary structure. This eliminates the need to provide a separate fire sprinkler system for small auxiliary buildings. Items that should be considered before finalizing fire sprinkler design should include the following:

- (1) Actual physical distance between adjacent structures
- (2) Potential for the property to be split into separate parcels and sold separately
- (3) Square footage of both the primary and auxiliary structures
- (4) Difficulties in providing a separate water supply to the auxiliary structure

- (5) Occupancy/hazard of the auxiliary structure
- (6) Ability of emergency response personnel to easily identify the structure from which waterflow is originating

A.8.3.1.1 Whenever possible, sprinklers should be installed in piping after the piping is placed in its final position and secured by hangers in accordance with this standard.

A.8.3.1.3 The purpose of this requirement is to minimize the obstruction of the discharge pattern.

A.8.3.1.5.1 Protective caps and straps are intended to provide temporary protection for sprinklers during shipping and installation.

A.8.3.1.5.2 Protective caps and straps can be removed from upright sprinklers, from sprinklers that are fitted with sprinkler guards, and from sprinklers that are not likely to be subject to damage due to construction activities or other events. In general, protective caps and straps should not be removed until construction activities or other events have progressed to the point where the sprinklers will not be subjected to conditions that could cause them to be damaged. Consideration should be given to leaving the protective caps and straps in place where other construction work is expected to take place, adjacent to the sprinklers following their installation, until that activity is complete. Protective caps and straps on sidewall and pendent sprinklers, for example, should be left in place pending installation of the wall and ceiling systems and then removed as finish escutcheons are being installed. In retrofit applications, with minimal follow-on trade construction activity, and with upright sprinklers, it would be reasonable to remove the caps and straps immediately following the installation on the sprinkler piping.

A.8.3.2.1 For protection of baled cotton, fire tests and actual fire experience indicate an initial low heat release; thus, sprinklers in the ordinary temperature range should offer some advantage by opening faster than those of intermediate- or high-temperature classifications under similar conditions.

A.8.3.2.7 Where high temperature-rated sprinklers are installed at the ceiling, high temperature-rated sprinklers also should extend beyond storage in accordance with Table A.8.3.2.7.

Table A.8.3.2.7 Distance Beyond Perimeter of Storage for High-Hazard Occupancies Protected with High Temperature-Rated Sprinklers

Design Area		Distance	
ft ²	m ²	ft	m
2000	186.0	30	9.1
3000	278.7	40	12.0
4000	371.6	45	13.7
5000	464.5	50	15.2
6000	557.4	55	16.7

A.8.3.3.1 When renovations occur in an existing building and no changes are made in the existing sprinkler system, this section is not intended to require the replacement of existing standard sprinklers with quick-response sprinklers.

A.8.4 The selection of a sprinkler type will vary by occupancy. Where more than one type of sprinkler is used within a compartment, sprinklers with similar response characteristics should be used (i.e., standard or quick-response). However, some hazards might benefit from designs that include the use of both standard and quick-response sprinklers. Examples include rack storage protected by standard-response ceiling sprinklers and quick-response in-rack sprinklers. Another case might include opening protection using closely spaced quick-response sprinklers with standard-response sprinklers in the adjoining areas. Other designs can be compromised when sprinklers of differing sensitivity are mixed. An example is a system utilizing ESFR sprinklers adjacent to a system using high-temperature standard-response sprinklers as might be found in a warehouse. In this case, a fire occurring near the boundary might open ESFR sprinklers, which would not be contemplated in the standard-response system design.

A.8.4.5.1 The response and water distribution pattern of listed residential sprinklers have been shown by extensive fire testing to provide better control than spray sprinklers in residential occupancies. These sprinklers are intended to prevent flashover in the room of fire origin, thus improving the chance for occupants to escape or be evacuated.

The protection area for residential sprinklers is defined in the listing of the sprinkler as a maximum square or rectangular area. Listing information is presented in even 2 ft (0.65 m) increments from 12 ft to 20 ft (3.9 m to 6.5 m). When a sprinkler is selected for an application, its area of coverage must be equal to or greater than both the length and width of the hazard area. For example, if the hazard to be protected is a room 13 ft 6 in. (4.4 m) wide and 17 ft 6 in. (5.6 m) long, a sprinkler that is listed to protect a rectangular area of 14 ft × 18 ft (4.5 m × 5.8 m) or a square area of 18 ft × 18 ft (5.8 m × 5.8 m) must be selected. The flow used in the calculations is then selected as the flow required by the listing for the selected coverage.

A.8.4.6.3 Storage in single-story or multistory buildings can be permitted, provided the maximum ceiling/roof height as specified in Table 8.12.2.2.1 is satisfied for each storage area.

A.8.4.7.2 The purpose of this requirement is to avoid scale accumulation.

A.8.4.8.1 Tests of standard sprinklers by approved laboratories have traditionally encompassed a fire test using a 350 lb (160 kg) wood crib and water distribution tests in which water is collected in pans from several arrangements of sprinklers to evaluate distribution under non-fire conditions.

Tests of special sprinklers are customized to evaluation responsiveness, distribution, and other unique characteristics of the sprinkler to control or suppress a fire. Depending on the intended use, these tests might include variables such as the following:

- (1) The location of the fire relative to the sprinklers (i.e., below one sprinkler, between two or between four sprinklers)

- (2) Fire conditions that encompass a variety of fire growth rates representative of anticipated conditions of use
- (3) Tests where multiple sprinklers are expected to operate
- (4) Adverse conditions of use (i.e., pipe shadows or other obstructions to discharge)
- (5) Effect of a fire plume on water sprinkler discharge

The listing of new sprinkler technology for storage protection should include large-scale fire testing using a commodity or commodities representative of those intended to be protected and should consider at least the following variables:

- (1) Ignition under one, between two, and between four sprinklers
- (2) Range of clearances between the sprinkler and the commodity
- (3) Test(s) at or near the minimum pressures specified for the sprinkler

A.8.4.10.2 The clearance space around the sprinkler barrel should be sealed to avoid leakage of air into the freezing area which could result in the formation of condensate around the sprinkler frame which could inhibit or cause premature operation. See Figure A.8.4.10.2(a) and Figure A.8.4.10.2(b).

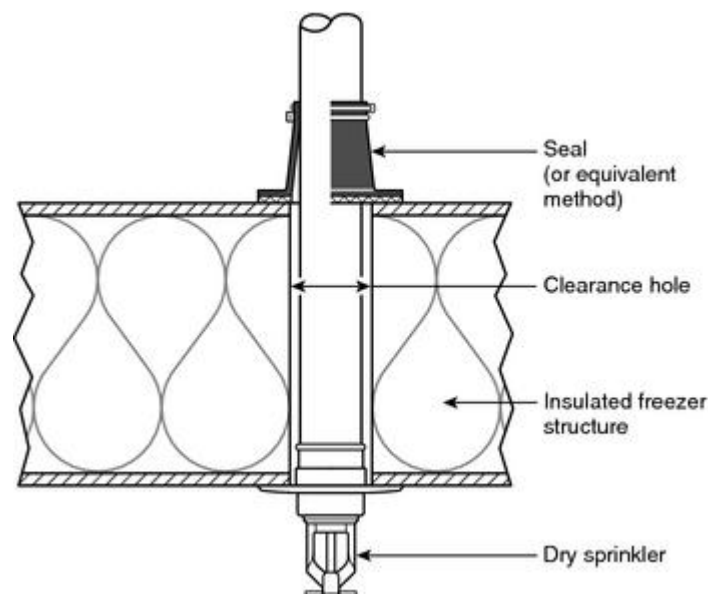

FIGURE A.8.4.10.2(a) Dry Sprinkler Seal Arrangement — Seal on Exterior of Freezer Structure.

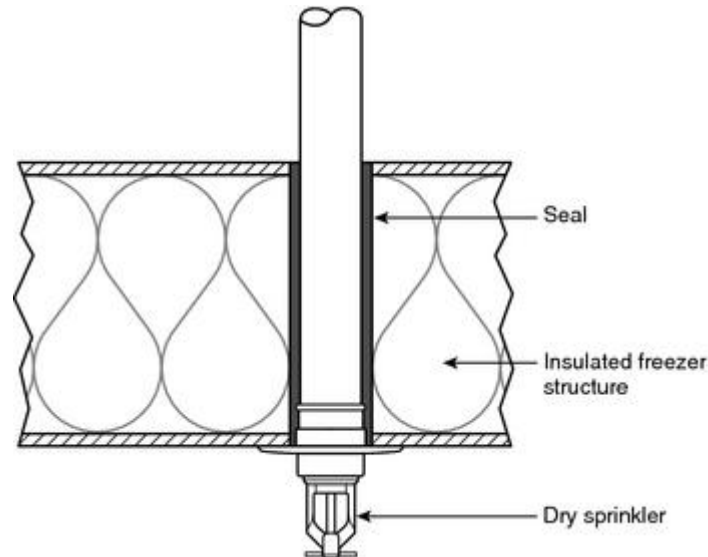

FIGURE A.8.4.10.2(b) Dry Sprinkler Seal Arrangement — Seal Within Freezer Structure.

A.8.5.4.1 Batt insulation creates an effective thermal barrier and can be considered the ceiling/roof deck when determining distances between deflector and ceiling. The insulation needs to be installed in each pocket (not just above the sprinkler) and attached to the ceiling/roof in such a manner that it will not fall out during a fire prior to sprinkler activation.

A.8.5.5.1 See Figure A.8.5.5.1.

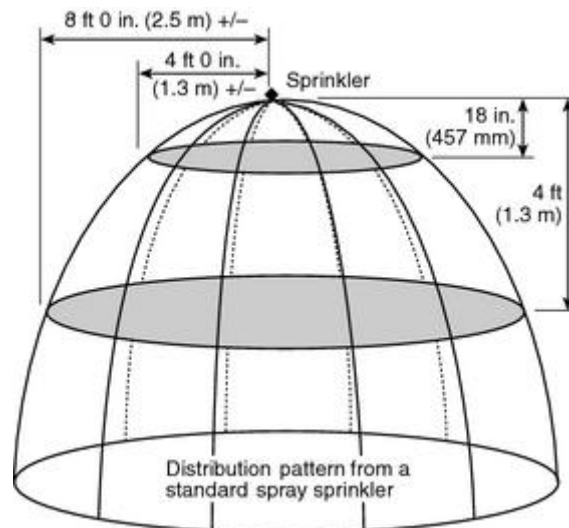

FIGURE A.8.5.5.1 Obstructions to Sprinkler Discharge Pattern Development for Standard Upright or Pendent Spray Sprinklers.

A.8.5.5.2 Where of a depth that will obstruct the spray discharge pattern, girders, beams, or trusses forming narrow pockets of combustible construction along walls can require additional sprinklers.

A.8.5.5.3 Frequently, additional sprinkler equipment can be avoided by reducing the width

of decks or galleries and providing proper clearances. Slatting of decks or walkways or the use of open grating as a substitute for automatic sprinklers thereunder is not acceptable. The use of cloth or paper dust tops for rooms forms obstruction to water distribution. If dust tops are used, the area below should be sprinklered.

A.8.5.5.3.3 Sprinklers under open gratings should be provided with shields. Shields over automatic sprinklers should not be less, in least dimension, than four times the distance between the shield and fusible element, except special sprinklers incorporating a built-in shield need not comply with this recommendation if listed for the particular application.

A.8.5.6 The fire protection system design should consider the maximum storage height. For new sprinkler installations, maximum storage height is the usable height at which commodities can be stored above the floor while the minimum required unobstructed space below sprinklers is maintained. Where evaluating existing situations, maximum storage height is the maximum existing storage height if space between the sprinklers and storage is equal to or greater than that required.

Building heights where baled cotton is stored should allow for proper clearance between the pile height and sprinkler deflectors. Fire tests of high-piled storage have shown that sprinklers are generally more effective if located 1½ ft to 4½ ft (0.45 m to 1.4 m) above the storage height.

A.8.5.6.1 The 18 in. (457 mm) clearance does not apply to vehicles in concrete parking structures.

A.8.6.2.2.1 When the spacing between sprinklers perpendicular to the slope exceeds 8 ft (2.44 m), it is necessary to increase the minimum density or sprinkler operating pressure as noted in Table 8.6.2.2.1(a) and in 8.6.4.1.4. Time to sprinkler activation and water distribution can be affected within combustible concealed spaces with sloped roofs or ceilings in these combustible concealed spaces, especially where wood joist rafters or wood truss construction is used. To reduce the probability of fires in these combustible concealed spaces involving the combustible roof or ceiling construction above standard spray sprinklers, more stringent spacing and installation guidelines apply.

A.8.6.3.2.3 See Figure A.8.6.3.2.3.

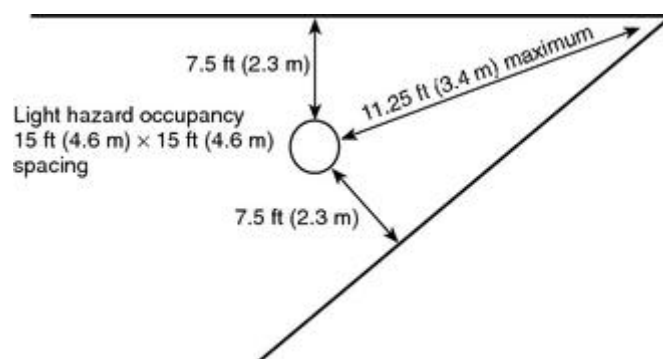

FIGURE A.8.6.3.2.3 Maximum Distance from Walls.

A.8.6.3.2.4 An example of sprinklers in small rooms for hydraulically designed and pipe

schedule systems is shown in Figure A.8.6.3.2.4(a), and examples for hydraulically designed systems only are shown in Figure A.8.6.3.2.4(b), Figure A.8.6.3.2.4(c), and Figure A.8.6.3.2.4(d).

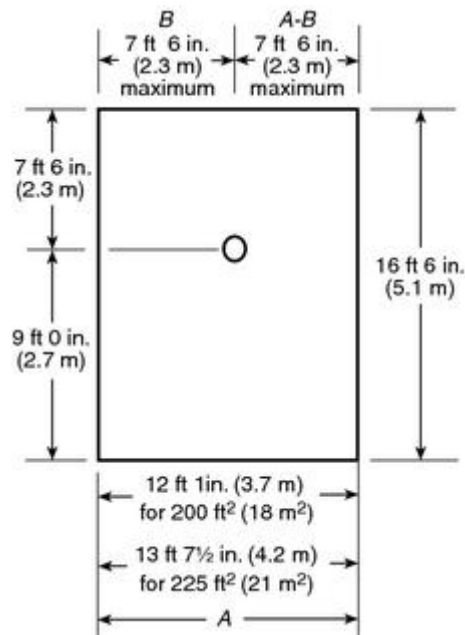

FIGURE A.8.6.3.2.4(a) Small Room Provision — One Sprinkler.

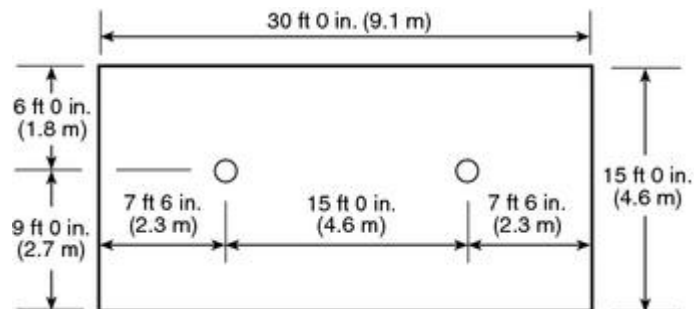

FIGURE A.8.6.3.2.4(b) Small Room Provision — Two Sprinklers Centered Between Sidewalls.

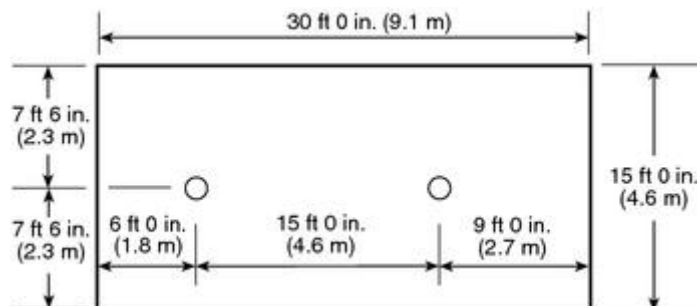

FIGURE A.8.6.3.2.4(c) Small Room Provision — Two Sprinklers Centered Between Top and Bottom Walls.

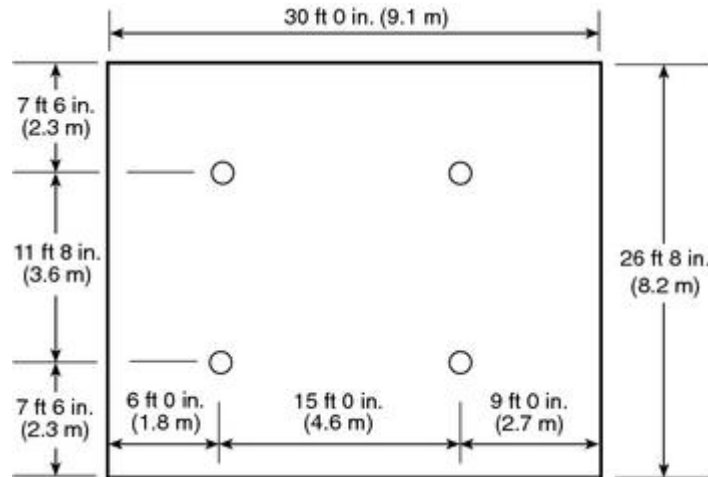

FIGURE A.8.6.3.2.4(d) Small Room Provision — Four Sprinklers.

A.8.6.4.1.2(5) For concrete joists spaced less than 3 ft (0.91 m) on center, the rules for obstructed construction shown in 8.6.4.1.2 apply. [See Figure A.8.6.4.1.2(5).]



FIGURE A.8.6.4.1.2(5) Typical Concrete Joist Construction.

A.8.6.4.1.3.2 Saw-toothed roofs have regularly spaced monitors of saw tooth shape, with the nearly vertical side glazed and usually arranged for venting. Sprinkler placement is limited to a maximum of 3 ft (0.91 m) down the slope from the peak because of the effect of venting on sprinkler sensitivity.

A.8.6.4.1.3.3 Generally, where applying the requirements of this section, a surface having a slope greater than or equal to 18 in 12 is needed.

A.8.6.5.2.1.3 The rules of 8.6.5.2.1.3 (known as the “Three Times Rule”) have been written to apply to obstructions where the sprinkler can be expected to get water to both sides of the obstruction without allowing a significant dry shadow on the other side of the obstruction. This works for small noncontinuous obstructions and for continuous obstructions where the sprinkler can throw water over and under the obstruction, such as the bottom chord of an open truss or joist. For solid continuous obstructions, such as a beam, the Three Times Rule is ineffective since the sprinkler cannot throw water over and under the obstruction. Sufficient water must be thrown under the obstruction to adequately cover the floor area on the other side of the obstruction. To ensure this, compliance with the rules of 8.6.5.1.2 is necessary.

A.8.6.5.2.1.4 It is the intent of this section to exempt nonstructural elements in light and ordinary hazard occupancies from the obstruction criteria commonly called the “Three Times Rule.” However, the other obstruction rules, including the “Beam Rule” (8.6.5.1.2) and the “Wide Obstruction Rule” (8.6.5.3.3), still apply. If an obstruction is so close to a sprinkler that water cannot spray on both sides, it is effectively a continuous obstruction as far as the sprinkler is concerned and the Beam Rule should be applied.

It is not the intent of this section to permit the use of fixtures and architectural features or treatments to conceal, obscure, or otherwise obstruct sprinkler discharge. The requirement should be applied in accordance with the performance objectives in 8.6.5.1.

A.8.6.5.2.2.1 Testing has shown that privacy curtains supported from the ceiling by mesh fabric do not obstruct the distribution pattern in a negative way as long as the mesh is 70 percent or more open and extends from the ceiling a minimum of 22 in. (559 mm).

A.8.6.5.3 See A.8.5.5.3.

A.8.6.6 The 18 in. (457 mm) dimension is not intended to limit the height of shelving on a wall or shelving against a wall in accordance with 8.6.6. Where shelving is installed on a wall and is not directly below sprinklers, the shelves, including storage thereon, can extend above the level of a plane located 18 in. (457 mm) below ceiling sprinkler deflectors. Shelving, and any storage thereon, directly below the sprinklers cannot extend above a plane located 18 in. (457 mm) below the ceiling sprinkler deflectors.

A.8.7.4.1.3.2 See Figure A.8.7.4.1.3.2.

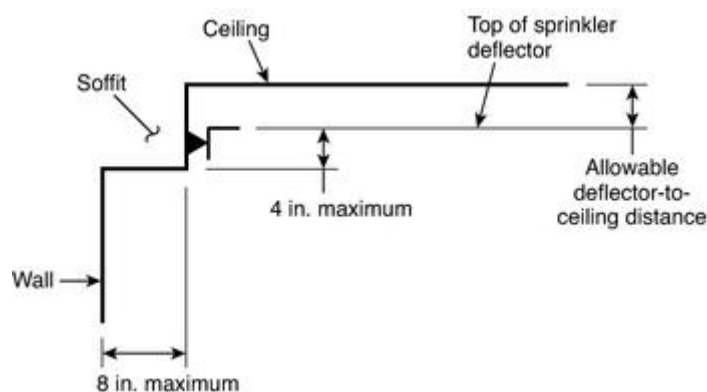

FIGURE A.8.7.4.1.3.2 Location Sidewalls with Respect to Soffits — Sidewall in Soffit.

A.8.7.4.1.3.3 See Figure A.8.7.4.1.3.3.

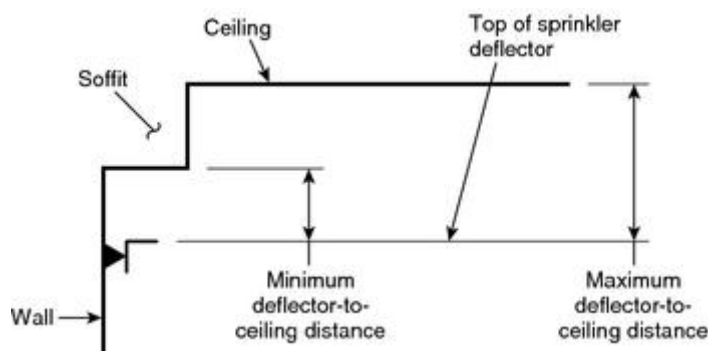

FIGURE A.8.7.4.1.3.3 Location Sidewalls with Respect to Soffits — Sidewall Under Soffit.

A.8.7.5.2.1.3 The rules of 8.7.5.2.1.3 (known as the “Three Times Rule”) have been written to apply to obstructions where the sprinkler can be expected to get water to both sides of the

obstruction without allowing a significant dry shadow on the other side of the obstruction. This works for small noncontinuous obstructions and for continuous obstructions where the sprinkler can throw water over and under the obstruction, such as the bottom chord of an open truss or joist. For solid continuous obstructions, such as a beam, the Three Times Rule is ineffective since the sprinkler cannot throw water over and under the obstruction. Sufficient water must be thrown under the obstruction to adequately cover the floor area on the other side of the obstruction. To ensure this, compliance with the rules of 8.7.5.1.2 is necessary.

A.8.7.5.2.2.1 Testing has shown that privacy curtains supported from the ceiling by mesh fabric do not obstruct the distribution pattern in a negative way as long as the mesh is 70 percent or more open and extends from the ceiling a minimum of 22 in. (559 mm).

A.8.7.5.3 See A.8.5.5.3.

A.8.8.2.1 The protection area for extended coverage upright and pendent sprinklers is defined in the listing of the sprinkler as a maximum square area. Listing information is presented in even 2 ft (0.6 m) increments up to 20 ft (6.1 m). When a sprinkler is selected for an application, its area of coverage must be equal to or greater than both the length and width of the hazard area. For example, if the hazard to be protected is a room 13½ ft (4.1 m) wide and 17½ ft (5.3 m) long as indicated in Figure A.8.8.2.1, a sprinkler that is listed to protect an area of 18 ft × 18 ft (5.5 m × 5.5 m) must be selected. The flow used in the calculations is then selected as the flow required by the listing for the selected coverage.

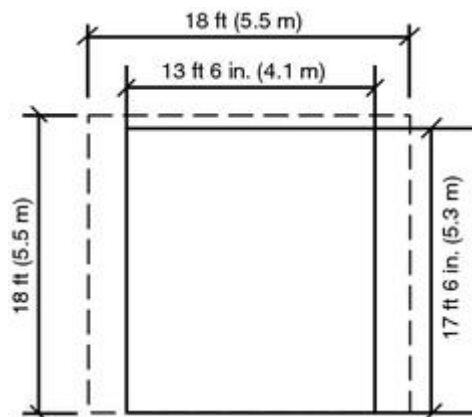

FIGURE A.8.8.2.1 Determination of Protection Area of Coverage for Extended Coverage Upright and Pendent Sprinklers.

A.8.8.2.2.1 Testing has shown that privacy curtains supported from the ceiling by mesh fabric do not obstruct the distribution pattern in a negative way as long as the mesh is 70 percent or more open and extends from the ceiling a minimum of 22 in. (559 mm).

A.8.8.4.1.3 Saw-toothed roofs have regularly spaced monitors of saw tooth shape, with the nearly vertical side glazed and usually arranged for venting. Sprinkler placement is limited to a maximum of 3 ft (0.91 m) down the slope from the peak because of the effect of venting on sprinkler sensitivity.

A.8.8.5.2.1.3 The rules of 8.8.5.2.1.3 (known as the “Four Times Rule”) have been written

to apply to obstructions where the sprinkler can be expected to get water to both sides of the obstruction without allowing a significant dry shadow on the other side of the obstruction. This works for small noncontinuous obstructions and for continuous obstructions where the sprinkler can throw water over and under the obstruction, such as the bottom chord of an open truss or joist. For solid continuous obstructions, such as a beam, the Four Times Rule is ineffective since the sprinkler cannot throw water over and under the obstruction. Sufficient water must be thrown under the obstruction to adequately cover the floor area on the other side of the obstruction. To ensure this, compliance with the rules of 8.8.5.1.2 is necessary.

A.8.8.5.3 See A.8.5.5.3.

A.8.9.2.1 The protection area for extended coverage sidewall spray sprinklers is defined in the listing of the sprinkler as a maximum square or rectangular area. Listing information is presented in even 2 ft (0.65 m) increments up to 28 ft (9 m) for extended coverage sidewall spray sprinklers. When a sprinkler is selected for an application, its area of coverage must be equal to or greater than both the length and width of the hazard area. For example, if the hazard to be protected is a room $14\frac{1}{2}$ ft (4.4 m) wide and $20\frac{2}{3}$ ft (6.3 m) long as indicated in Figure A.8.9.2.1, a sprinkler that is listed to protect an area of 16 ft \times 22 ft (4.9 m \times 6.7 m) must be selected. The flow used in the calculations is then selected as the flow required by the listing for the selected coverage.

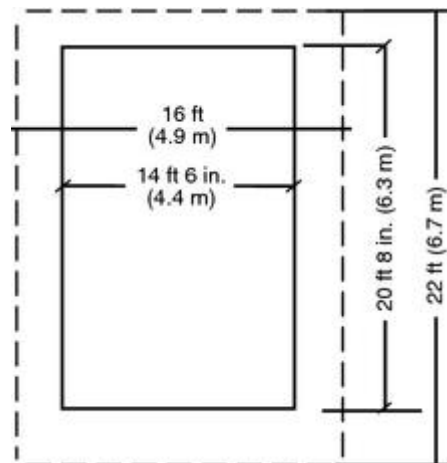

FIGURE A.8.9.2.1 Determination of Protection Area of Coverage for Extended Coverage Sidewall Sprinklers.

A.8.9.4.1.3.1 See Figure A.8.9.4.1.3.1.

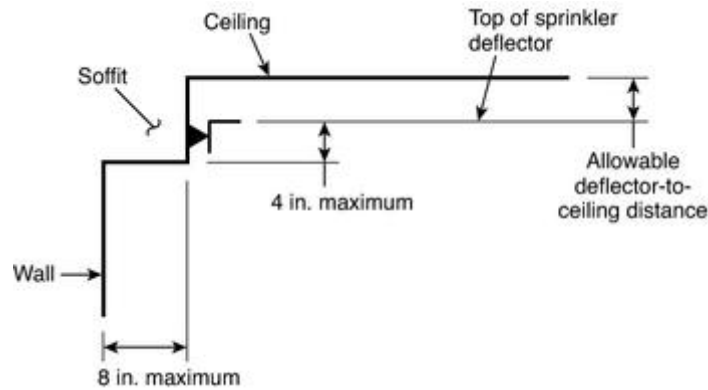

FIGURE A.8.9.4.1.3.1 Location of Extended Coverage Sidewalls with Respect to Soffits — Sidewall in Soffit.

A.8.9.4.1.3.2 See Figure A.8.9.4.1.3.2.

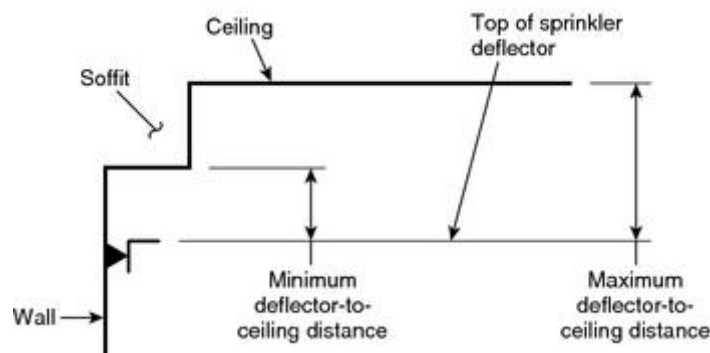

FIGURE A.8.9.4.1.3.2 Location of Extended Coverage Sidewalls with Respect to Soffits — Sidewall Under Soffit.

A.8.9.4.1.4 The requirements in 8.9.4.1.4 were developed from years of experience with NFPA 13 obstruction requirements and an additional test series conducted by the National Fire Sprinkler Association with the help of Tyco International (Valentine and Isman, *Kitchen Cabinets and Residential Sprinklers*, National Fire Sprinkler Association, November 2005), which included fire modeling, distribution tests, and full-scale fire tests. The test series showed that pendent sprinklers definitely provide protection for kitchens, even for fires that start under the cabinets. The information in the series was less than definitive for sidewall sprinklers, but distribution data show that sprinklers in the positions in this standard provide adequate water distribution in front of the cabinets and that sidewall sprinklers should be able to control a fire that starts under the cabinets. When protecting kitchens or similar rooms with cabinets, the pendent sprinkler should be the first option. If pendent sprinklers cannot be installed, the next best option is a sidewall sprinkler on the opposite wall from the cabinets, spraying in the direction of the cabinets. The third best option is the sidewall sprinkler on the same wall as the cabinets, on a soffit flush with the face of the cabinet. The last option should be putting sprinklers on the wall back behind the face of the cabinet because this location is subject to being blocked by items placed on top of the cabinets. It is not the intent of the committee to require sprinklers under kitchen cabinets.

A.8.9.5.2.1.3 The rules of 8.9.5.2.1.3 (known as the “Four Times Rule”) have been written to apply to obstructions where the sprinkler can be expected to get water to both sides of the obstruction without allowing a significant dry shadow on the other side of the obstruction. This works for small noncontinuous obstructions and for continuous obstructions where the sprinkler can throw water over and under the obstruction, such as the bottom chord of an open truss or joist. For solid continuous obstructions, such as a beam, the Four Times Rule is ineffective since the sprinkler cannot throw water over and under the obstruction. Sufficient water must be thrown under the obstruction to adequately cover the floor area on the other side of the obstruction. To ensure this, compliance with the rules of 8.9.5.1.2 is necessary.

A.8.9.5.2.2.1 Testing has shown that privacy curtains supported from the ceiling by mesh fabric do not obstruct the distribution pattern in a negative way as long as the mesh is 70 percent or more open and extends from the ceiling a minimum of 22 in. (559 mm).

A.8.9.5.3 See A.8.5.5.3.

A.8.10.2 Residential sprinklers should be used in compliance with their listing limits. Where there are no listed residential sprinklers for a particular arrangement other design approaches from NFPA 13 should be utilized, such as using quick-response sprinklers.

A.8.10.6.2.1.3 The rules of 8.10.6.2.1.3 (known as the “Four Times Rule”) have been written to apply to obstructions where the sprinkler can be expected to get water to both sides of the obstruction without allowing a significant dry shadow on the other side of the obstruction. This works for small noncontinuous obstructions and for continuous obstructions where the sprinkler can throw water over and under the obstruction, such as the bottom chord of an open truss or joist. For solid continuous obstructions, such as a beam, the Four Times Rule is ineffective since the sprinkler cannot throw water over and under the obstruction. Sufficient water must be thrown under the obstruction to adequately cover the floor area on the other side of the obstruction. To ensure this, compliance with the rules of 8.10.6.1.2 is necessary.

A.8.10.6.3 See A.8.5.5.3.

A.8.10.7.1.5 The requirements in 8.10.7.1.5 were developed from years of experience with NFPA 13 obstruction requirements and an additional test series conducted by the National Fire Sprinkler Association with the help of Tyco International (Valentine and Isman, *Kitchen Cabinets and Residential Sprinklers*, National Fire Sprinkler Association, November 2005), which included fire modeling, distribution tests and full-scale fire tests. The test series showed that pendent sprinklers definitely provide protection for kitchens, even for fires that start under the cabinets. The information in the series was less than definitive for sidewall sprinklers, but distribution data shows that sprinklers in the positions in this standard provide adequate water distribution in front of the cabinets and that sidewall sprinklers should be able to control a fire that starts under the cabinets. When protecting kitchens or similar rooms with cabinets, the pendent sprinkler should be the first option. If pendent sprinklers cannot be installed, the next best option is a sidewall sprinkler on the opposite wall from the cabinets, spraying in the direction of the cabinets. The third best option is the sidewall sprinkler on the same wall as the cabinets on a soffit flush with the face of the cabinet. The last option should be putting sprinklers on the wall back behind the face of the cabinet because this location is

subject to being blocked by items placed on top of the cabinets. It is not the intent of the committee to require sprinklers under kitchen cabinets.

A.8.10.7.2.1.3 The rules of 8.10.7.2.1.3 (known as the Four Times Rule) have been written to apply to obstructions where the sprinkler can be expected to get water to both sides of the obstruction without allowing a significant dry shadow on the other side of the obstruction. This works for small noncontinuous obstructions and for continuous obstructions where the sprinkler can throw water over and under the obstruction, such as the bottom chord of an open truss or joist. For solid continuous obstructions, such as a beam, the Four Times Rule is ineffective since the sprinkler cannot throw water over and under the obstruction. Sufficient water must be thrown under the obstruction to adequately cover the floor area on the other side of the obstruction. To ensure this, compliance with the rules of 8.10.6.1.2 is necessary.

A.8.10.7.2.1.7 The housing unit of the ceiling fan is expected to be addressed by the Four Times Rule.

A.8.10.7.3 See A.8.5.5.3.

A.8.11.2 Tests involving areas of coverage over 100 ft² (9.3 m²) for large drop sprinklers are limited in number, and use of areas of coverage over 100 ft² (9.3 m²) should be carefully considered.

A.8.11.3.1 It is important that sprinklers in the immediate vicinity of the fire center not skip, and this requirement imposes certain restrictions on the spacing.

A.8.11.4.1 If all other factors are held constant, the operating time of the first sprinkler will vary exponentially with the distance between the ceiling and deflector. At distances greater than 7 in. (178 mm), for other than open wood joist construction, the delayed operating time will permit the fire to gain headway, with the result that substantially more sprinklers operate. At distances less than 7 in. (178 mm), other effects occur. Changes in distribution, penetration, and cooling nullify the advantage gained by faster operation. The net result again is increased fire damage accompanied by an increase in the number of sprinklers operated. The optimum clearance between deflectors and ceiling is therefore 7 in. (178 mm). For open wood joist construction, the optimum clearance between deflectors and the bottom of joists is 3½ in. (89 mm).

A.8.11.5 To a great extent, large drop sprinklers rely on direct attack to gain rapid control of both the burning fuel and ceiling temperatures. Therefore, interference with the discharge pattern and obstructions to the distribution should be avoided.

A.8.11.5.2.1.3 The rules of 8.11.5.2.1.3 (known as the “Three Times Rule”) have been written to apply to obstructions where the sprinkler can be expected to get water to both sides of the obstruction without allowing a significant dry shadow on the other side of the obstruction. This works for small noncontinuous obstructions and for continuous obstructions where the sprinkler can throw water over and under the obstruction, such as the bottom chord of an open truss or joist. For solid continuous obstructions, such as a beam, the Three Times Rule is ineffective since the sprinkler cannot throw water over and under the obstruction. Sufficient water must be thrown under the obstruction to adequately cover the floor area on the other side of the obstruction. To ensure this, compliance with the rules

of 8.11.5.1.2 is necessary.

A.8.11.5.3 See A.8.5.5.3.

A.8.12.2.2.3 See Figure A.8.12.2.2.3.

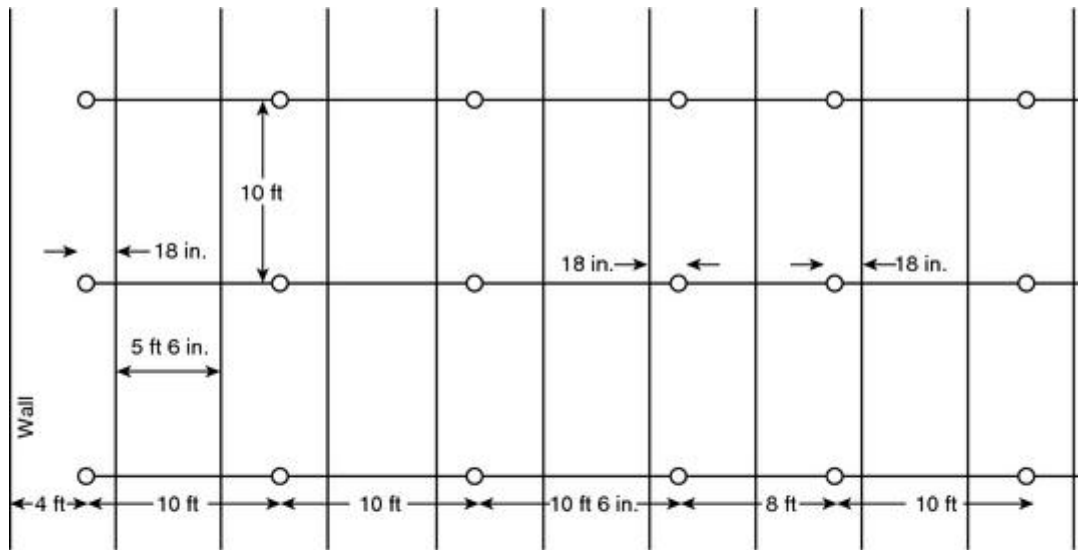

Example 1 of ESFR "Shift" Rule (bar joists or trusses 5 ft 6 in. o.c.)
Measurement shown is from centerline for ease of illustration; actual measurement to obstruction is to near edge of structural member.

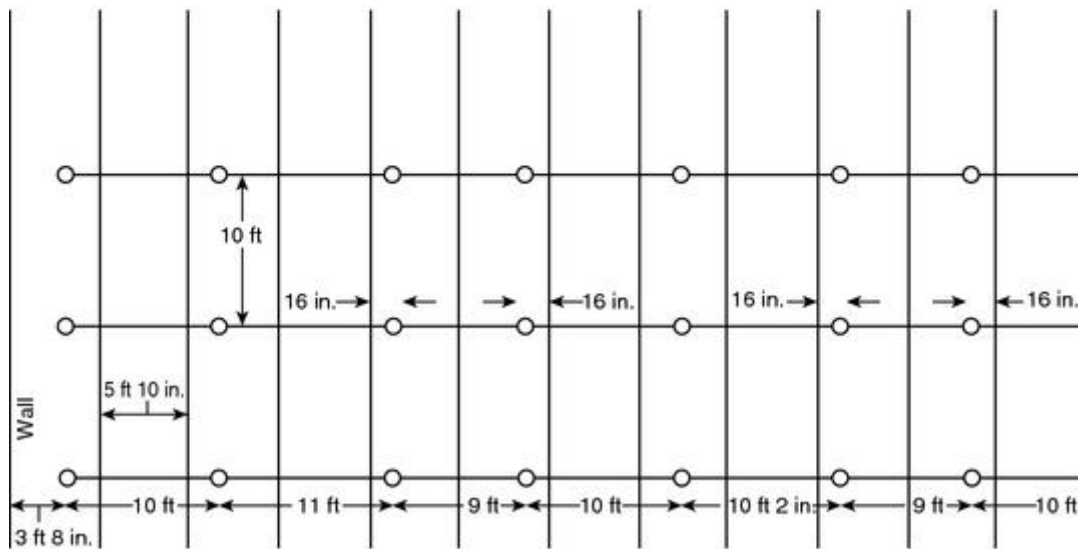

Example 2 of ESFR "Shift" Rule (bar joists or trusses 5 ft 10 in. o.c.)
Measurement shown is from centerline for ease of illustration; actual measurement to obstruction is to near edge of structural member.

FIGURE A.8.12.2.2.3 ESFR Sprinkler Spacing Within Trusses and Bar Joists.

A.8.12.3.1(3) See Figure A.8.12.2.2.3.

A.8.12.5.2 Isolated obstructions that block adjacent sprinklers in a similar manner should be treated as a continuous obstruction.

A.8.15.1.2 Paragraphs 8.15.1.2.3, 8.15.1.2.4, and 8.15.1.2.5 do not require sprinkler protection because it is not physically practical to install sprinklers in the types of concealed spaces discussed in these three exceptions. To reduce the possibility of uncontrolled fire spread, consideration should be given in these unsprinklered concealed space situations to using 8.15.1.2.7, 8.15.1.2.10, and 8.15.1.2.12.

A.8.15.1.2.1 Minor quantities of combustible materials such as but not limited to: cabling, nonmetallic plumbing piping, non-structural wood, etc. can be present in concealed spaces constructed of limited or noncombustible materials but should not typically be viewed as requiring sprinklers (*see 8.15.1.1*). For example, it is not the intent of this section to require sprinklers, which would not otherwise be required, in the interstitial space of a typical office building solely due to the presence of the usual amount of cabling within the space. The threshold value at which sprinklers become necessary in the concealed space is not defined.

A.8.15.1.2.6 See Figure A.8.15.1.2.6.

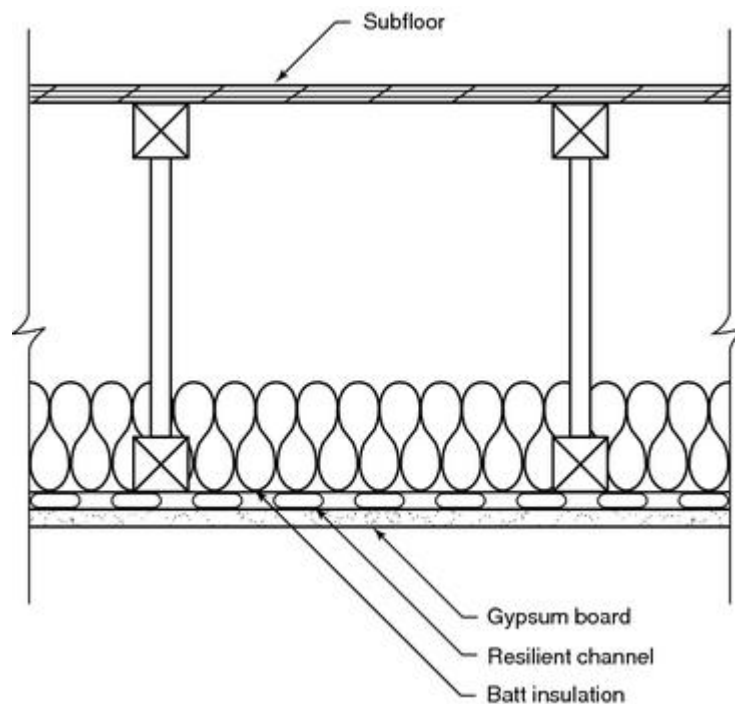

FIGURE A.8.15.1.2.6 Combustible Concealed Space Cross Section.

A.8.15.1.2.16 See Figure A.8.15.1.2.16 for one example.

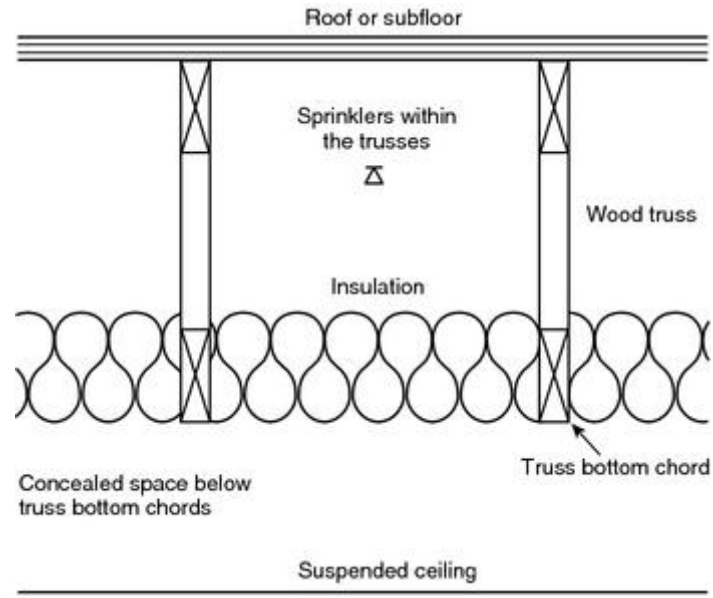

FIGURE A.8.15.1.2.16 One Acceptable Arrangement of a Concealed Space in Truss Construction Not Requiring Sprinklers.

A.8.15.2.2 Where practicable, sprinklers should be staggered at the alternate floor levels, particularly where only one sprinkler is installed at each floor level.

A.8.15.3.3 See Figure A.8.15.3.3(a) and Figure A.8.15.3.3(b). Sprinklers would be required in the case shown in Figure A.8.15.3.3(a) but not in the case shown in Figure A.8.15.3.3(b).

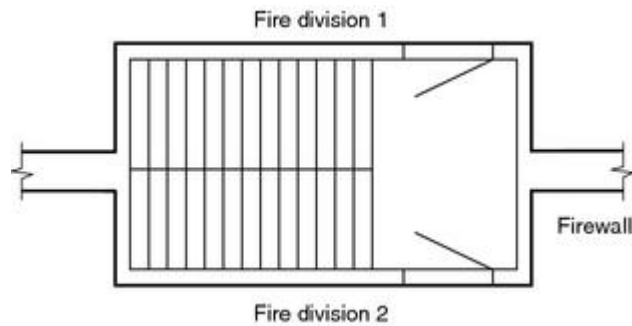

FIGURE A.8.15.3.3(a) Noncombustible Stair Shaft Serving Two Fire Sections.

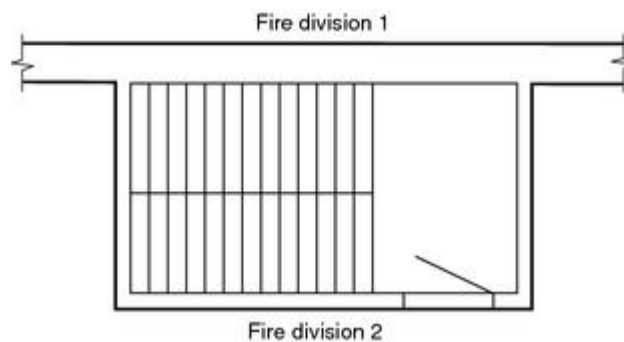

FIGURE A.8.15.3.3(b) Noncombustible Stair Shaft Serving One Fire Section.

A.8.15.4 Where sprinklers in the normal ceiling pattern are closer than 6 ft (1.8 m) from the water curtain, it might be preferable to locate the water curtain sprinklers in recessed baffle pockets. (See Figure A.8.15.4.)

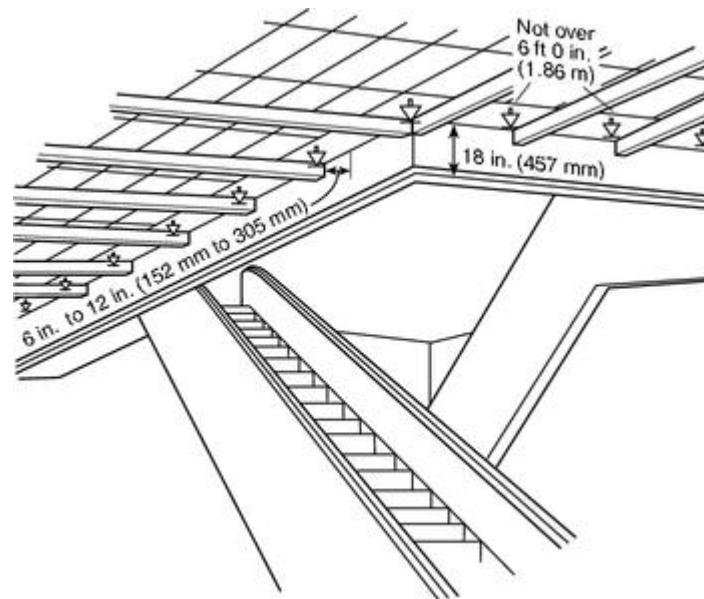

FIGURE A.8.15.4 Sprinklers Around Escalators.

A.8.15.4.1 It is the intent of this section to require closely spaced sprinklers and draft stops to openings where protection or enclosure is required by building and life safety codes.

A.8.15.5.1 The sprinklers in the pit are intended to protect against fires caused by debris, which can accumulate over time. Ideally, the sprinklers should be located near the side of the pit below the elevator doors, where most debris accumulates. However, care should be taken that the sprinkler location does not interfere with the elevator toe guard, which extends below the face of the door opening.

ASME A17.1, *Safety Code for Elevators and Escalators*, allows the sprinklers within 2 ft (0.65 m) of the bottom of the pit to be exempted from the special arrangements of inhibiting waterflow until elevator recall has occurred.

A.8.15.5.3 ASME A17.1, *Safety Code for Elevators and Escalators*, requires the shutdown of power to the elevator upon or prior to the application of water in elevator machine rooms or hoistways. This shutdown can be accomplished by a detection system with sufficient sensitivity that operates prior to the activation of the sprinklers (see also NFPA 72, *National Fire Alarm Code*). As an alternative, the system can be arranged using devices or sprinklers capable of effecting power shutdown immediately upon sprinkler activation, such as a waterflow switch without a time delay. This alternative arrangement is intended to interrupt power before significant sprinkler discharge.

A.8.15.5.4 Passenger elevator cars that have been constructed in accordance with ASME A17.1, *Safety Code for Elevators and Escalators*, Rule 204.2a (under A17.1a-1985 and later editions of the code) have limited combustibility. Materials exposed to the interior of the car and the hoistway, in their end-use composition, are limited to a flame spread index of 0 to 75

and a smoke developed index of 0 to 450.

A.8.15.7 Small loading docks, covered platforms, ducts, or similar small unheated areas can be protected by dry-pendent sprinklers extending through the wall from wet sprinkler piping in an adjacent heated area. Where protecting covered platforms, loading docks, and similar areas, a dry pendent sprinkler should extend down at a 45 degree angle. The width of the area to be protected should not exceed 7½ ft (2.3 m). Sprinklers should be spaced not over 12 ft (3.7 m) apart. (See Figure A.8.15.7.)

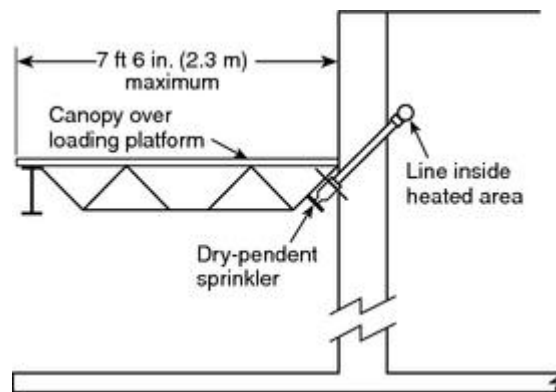

FIGURE A.8.15.7 Dry Pendent Sprinklers for Protection of Covered Platforms, Loading Docks, and Similar Areas.

A.8.15.7.1 Balconies, decks, and similar projections from the building should be treated as exterior roofs and canopies when applying the criteria of 8.15.7.1.

A.8.15.7.2 Vehicles that are temporarily parked are not considered storage. Areas located at drive-in bank windows or porte-cocheres at hotels and motels normally do not require sprinklers where there is no occupancy above, where the area is entirely constructed of noncombustible or limited-combustible materials or fire retardant treated lumber, and where the area is not the only means of egress. However, areas under exterior ceilings where the building is sprinklered should be protected due to the occupancy above.

A.8.15.7.5 Short-term transient storage, such as that for delivered packages, and the presence of planters, newspaper machines, and so forth, should not be considered storage or handling of combustibles.

A.8.15.8.2 Portable wardrobe units, such as those typically used in nursing homes and mounted to the wall, do not require sprinklers to be installed in them. Although the units are attached to the finished structure, this standard views those units as pieces of furniture rather than as a part of the structure; thus, sprinklers are not required.

A.8.15.9 Library stacks are high-density book storage areas and should not be confused with the typical library bookshelves and aisles in the general browsing areas.

A.8.15.11 The combustible materials present inside industrial ovens and furnaces can be protected by automatic sprinklers. Wet sprinkler systems are preferred. However, water-filled piping exposed to heat within an oven or furnace can incur deposition and buildup of minerals within the pipe. If the oven or furnace could be exposed to freezing temperatures, dry pendent sprinklers are an alternative to wet pipe systems. Another option

is to use a dry pipe system.

The preferred arrangement for piping is outside of the oven; the sprinkler should be installed in the pendent position. The sprinkler temperature rating should be at least 50°F (28°C) greater than the high-temperature limit setting of the oven or applicable zone. As a minimum, the sprinkler system inside the oven or furnace should be designed to provide 15 psi (1 bar) with all sprinklers operating inside the oven/furnace. Sprinkler spacing on each branch line should not exceed 12 ft (3.7 m).

A.8.15.13 The installation of open-grid egg crate, louver, or honeycomb ceilings beneath sprinklers restricts the sideways travel of the sprinkler discharge and can change the character of discharge.

A.8.15.14.4 Drop-out ceilings do not provide the required protection for soft-soldered copper joints or other piping that requires protection.

A.8.15.14.5 The ceiling tiles might drop before sprinkler operation. Delayed operation might occur because heat must then bank down from the deck above before sprinklers will operate.

A.8.15.15.2 For tests of sprinkler performance in fur vaults, see “Fact Finding Report on Automatic Sprinkler Protection for Fur Storage Vaults” of Underwriters Laboratories Inc., dated November 25, 1947.

Sprinklers should be listed old-style with orifice sizes selected to provide a flow rate as close as possible to, but not less than, 20 gpm (76 L/min) per sprinkler, for four sprinklers, based on the water pressure available.

Sprinklers in fur storage vaults should be located centrally over the aisles between racks and should be spaced not over 5 ft (1.5 m) apart along the aisles.

Where sprinklers are spaced 5 ft (1.5 m) apart along the sprinkler branch lines, pipe sizes should be in accordance with the following schedule:

1 in. (25 mm) — 4 sprinklers

1¼ in. (32 mm) — 6 sprinklers

1½ in. (40 mm) — 10 sprinklers

2 in. (50 mm) — 20 sprinklers

2½ in. (65 mm) — 40 sprinklers

3 in. (80 mm) — 80 sprinklers

A.8.15.19.1 Outlets meeting the requirements of this standard should be provided in anticipation of the final finished area.

A.8.15.19.2 Providing 1 in. (25 mm) minimum outlets with bushings can provide for future changes in building uses or occupancies.

A.8.15.21 See Figure A.8.15.21.

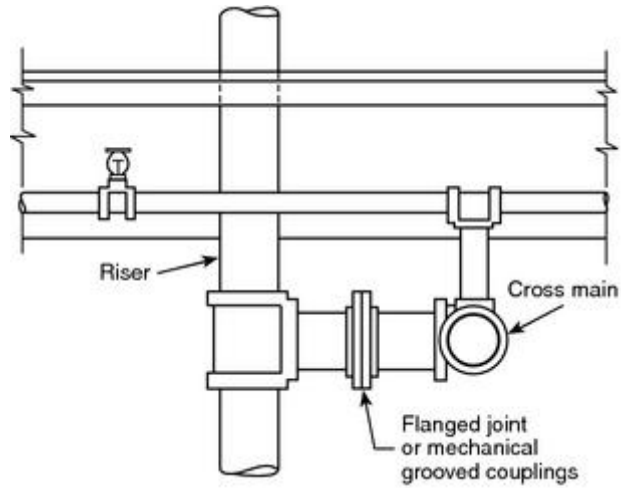

FIGURE A.8.15.21 One Arrangement of Flanged Joint at Sprinkler Riser.

A.8.16.1.1 See Figure A.8.16.1.1.

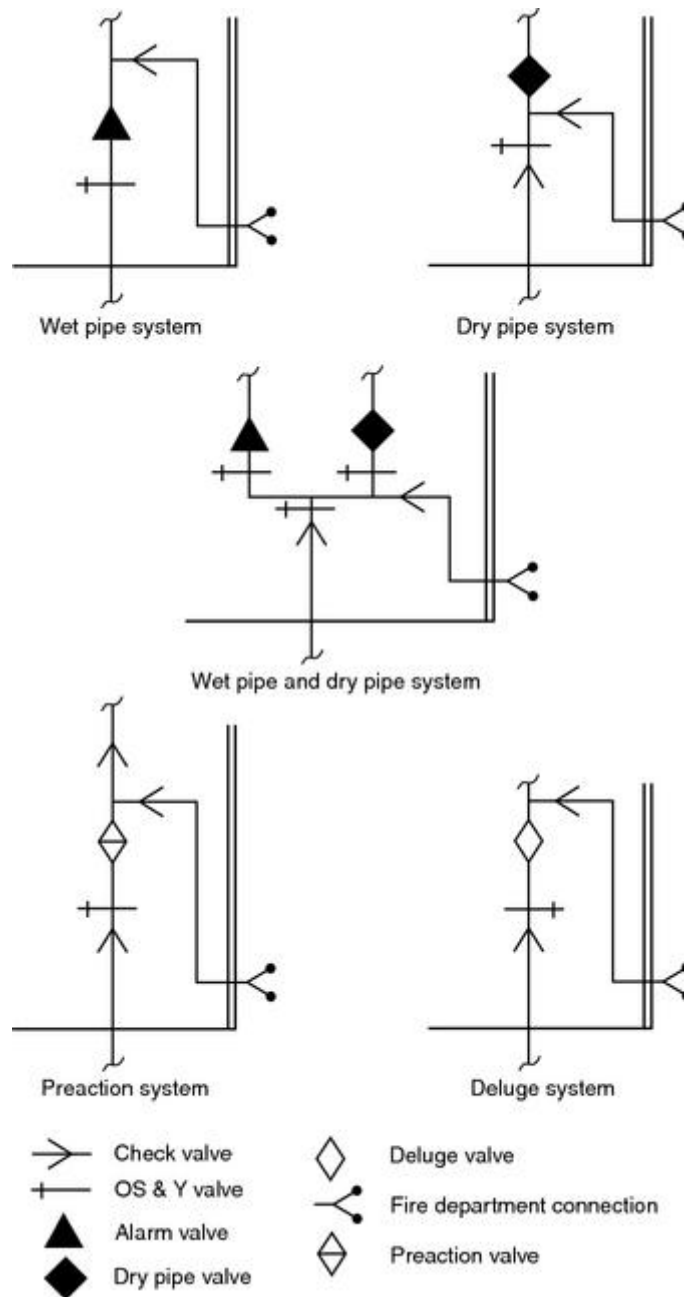

FIGURE A.8.16.1.1 Examples of Acceptable Valve Arrangements.

A.8.16.1.1.1 A water supply connection should not extend into a building or through a building wall unless such connection is under the control of an outside listed indicating valve or an inside listed indicating valve located near the outside wall of the building.

All valves controlling water supplies for sprinkler systems or portions thereof, including floor control valves, should be accessible to authorized persons during emergencies. Permanent ladders, clamped treads on risers, chain-operated hand wheels, or other accepted means should be provided where necessary.

Outside control valves are suggested in the following order of preference:

- (1) Listed indicating valves at each connection into the building at least 40 ft (12.2 m) from buildings if space permits
- (2) Control valves installed in a cutoff stair tower or valve room accessible from outside
- (3) Valves located in risers with indicating posts arranged for outside operation.
- (4) Key-operated valves in each connection into the building

A.8.16.1.1.2 The management is responsible for the supervision of valves controlling water supply for fire protection and should exert every effort to see that the valves are maintained in the normally open position. This effort includes special precautions to ensure that protection is promptly restored by completely opening valves that are necessarily closed during repairs or alterations. The precautions apply equally to valves controlling sprinklers and other fixed water-based fire suppression systems, hydrants, tanks, standpipes, pumps, street connections, and sectional valves.

Either one or a combination of the methods of valve supervision described in the following list is considered essential to ensure that the valves controlling fire protection systems are in the normally open position. The methods described are intended as an aid to the person responsible for developing a systematic method of determining that the valves controlling sprinkler systems and other fire protection devices are open.

Continual vigilance is necessary if valves are to be kept in the open position. Responsible day and night employees should be familiar with the location of all valves and their proper use.

The authority having jurisdiction should be consulted as to the type of valve supervision required. Contracts for equipment should specify that all details are to be subject to the approval of the authority having jurisdiction.

- (1) *Central Station Supervisory Service.* Central station supervisory service systems involve complete, constant, and automatic supervision of valves by electrically operated devices and circuits continually under test and operating through an approved outside central station, in compliance with *NFPA 72, National Fire Alarm Code*. It is understood that only such portions of *NFPA 72* that relate to valve supervision should apply.
- (2) *Proprietary Supervisory Service Systems.* Proprietary supervisory service systems include systems where the operation of a valve produces some form of signal and record at a common point by electrically operated devices and circuits continually under test and operating through a central supervising station at the property protected, all in compliance with the standards for the installation, maintenance, and use of local protective, auxiliary protective, remote station protective, and proprietary signaling systems. It is understood that only portions of the standards that relate to valve supervision should apply.

The standard method of locking, sealing, and tagging valves to prevent, so far as possible, their unnecessary closing, to obtain notification of such closing, and to aid in restoring the valve to normal condition is a satisfactory alternative to valve supervision. The authority having jurisdiction should be consulted regarding details for specific cases.

Where electrical supervision is not provided, locks or seals should be provided on all valves and should be of a type acceptable to the authority having jurisdiction.

Seals can be marked to indicate the organization under whose jurisdiction the sealing is conducted. All seals should be attached to the valve in such a manner that the valves cannot be operated without breaking the seals. Seals should be of a character to prevent injury in handling and to prevent reassembly when broken. When seals are used, valves should be inspected weekly. The authority having jurisdiction can require a valve tag to be used in conjunction with the sealing.

A padlock, with a chain where necessary, is especially desirable to prevent unauthorized closing of valves in areas where valves are subject to tampering. When such locks are employed, valves should be inspected monthly.

If valves are locked, any distribution of keys should be restricted to only those directly responsible for the fire protection system. Multiple valves should not be locked together; they should be individually locked.

The individual performing the inspections should determine that each valve is in the normal position, properly locked or sealed, and so note on an appropriate record form while still at the valve. The authority having jurisdiction should be consulted for assistance in preparing a suitable report form for this activity.

Identification signs should be provided at each valve to indicate its function and what it controls.

The position of the spindle of OS&Y valves or the target on the indicator valves cannot be accepted as conclusive proof that the valve is fully open. The opening of the valve should be followed by a test to determine that the operating parts have functioned properly.

The test consists of opening the main drain valve and permitting free flow of water until the gauge reading becomes stationary. If the pressure drop is excessive for the water supply involved, the cause should be determined immediately and the proper remedies taken. When sectional valves or other special conditions are encountered, other methods of testing should be used.

If it becomes necessary to break a seal for emergency reasons, the valve, following the emergency, should be opened by the person responsible for the fire protection of the plant, or his or her designated representative, and this person should apply a seal at the time of the valve opening. This seal should be maintained in place until such time as the authority having jurisdiction can replace it with one of its own.

Seals or locks should not be applied to valves reopened after closure until such time as the inspection procedure is carried out.

Where water is shut off to the sprinkler or other fixed water-based fire suppression systems, a guard or other qualified person should be placed on duty and required to continuously patrol the affected sections of the premises until such time as protection is restored.

During specific critical situations, a person should be stationed at the valve so that the valve can be reopened promptly if necessary. It is the intent of this section that the person remain

within sight of the valve and have no other duties beyond this responsibility. This procedure is considered imperative when fire protection is shut off immediately following a fire.

An inspection of all other fire protection equipment should be made prior to shutting off water in order to make sure it is in operative condition.

In case of changes to fire protection equipment, all possible work should be done in advance of shutting off the water so that final connections can be made quickly and protection restored promptly. Many times it will be found that by careful planning open outlets can be plugged and protection restored on a portion of the equipment while the alterations are being made.

Where changes are being made in underground piping, all possible piping should be laid before shutting off the water for final connections. Where possible, temporary feed lines, such as temporary piping for reconnection of risers by hose lines, and so forth, should be used to afford maximum protection. The plant, public fire department, and other authorities having jurisdiction should be notified of all impairments to fire protection equipment.

A.8.16.1.1.3 Where check valves are buried, they should be made accessible for maintenance. This can be accomplished by a valve pit or any means that renders the valve accessible. See Figure A.8.16.1.1.4.

A.8.16.1.1.3.5 Where a system having only one dry pipe valve is supplied with city water and a fire department connection, it will be satisfactory to install the main check valve in the water supply connection immediately inside of the building. In instances where there is no outside control valve, the system indicating valve should be placed at the service flange, on the supply side of all fittings.

A.8.16.1.1.4 See Figure A.8.16.1.1.4. For additional information on controlling valves, see NFPA 22, *Standard for Water Tanks for Private Fire Protection*.

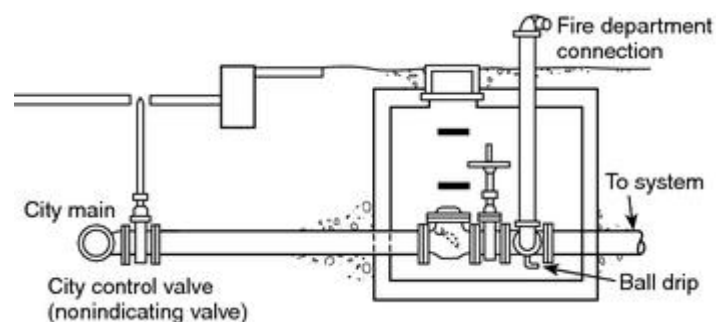

FIGURE A.8.16.1.1.4 Pit for Gate Valve, Check Valve, and Fire Department Connection.

A.8.16.1.1.5 For additional information on controlling valves, see NFPA 22, *Standard for Water Tanks for Private Fire Protection*.

A.8.16.1.1.6 Check valves on tank or pump connections, when located underground, can be placed inside of buildings and at a safe distance from the tank riser or pump, except in cases where the building is entirely of one fire area, when it is ordinarily considered satisfactory to locate the check valve overhead in the lowest level.

A.8.16.1.1.7 It might be necessary to provide valves located in pits with an indicator post extending above grade or other means so that the valve can be operated without entering the pit.

A.8.16.1.2.3 Where the relief valve operation would result in water being discharged onto interior walking or working surfaces, consideration should be given to piping the discharge from the valve to a drain connection or other safe location.

A.8.16.1.3 Outside control valves are suggested in the following order of preference:

- (1) Listed indicating valves at each connection into the building at least 40 ft (12.2 m) from buildings if space permits
- (2) Control valves installed in a cutoff stair tower or valve room accessible from outside
- (3) Valves located in risers with indicating posts arranged for outside operation
- (4) Key-operated valves in each connection into the building

Post-indicator valves should be located not less than 40 ft (12.2 m) from buildings. When post-indicator valves cannot be placed at this distance, they are permitted to be located closer, or wall post-indicator valves can be used, provided they are set in locations by blank walls where the possibility of injury by falling walls is unlikely and from which people are not likely to be driven by smoke or heat. Usually, in crowded plant yards, they can be placed beside low buildings, near brick stair towers, or at angles formed by substantial brick walls that are not likely to fall.

A.8.16.1.4.2 A valve wrench with a long handle should be provided at a convenient location on the premises.

A.8.16.1.6 In-rack sprinklers and ceiling sprinklers selected for protection should be controlled by at least two separate indicating valves and drains. In higher rack arrangements, consideration should be given to providing more than one in-rack control valve in order to limit the extent of any single impairment.

A.8.16.2.1 All piping should be arranged where practicable to drain to the main drain valve.

A.8.16.2.4 Figure A.8.16.2.4 is an example of an unacceptable arrangement. Because it will not give a true residual reading, it will indicate an excessive pressure drop.

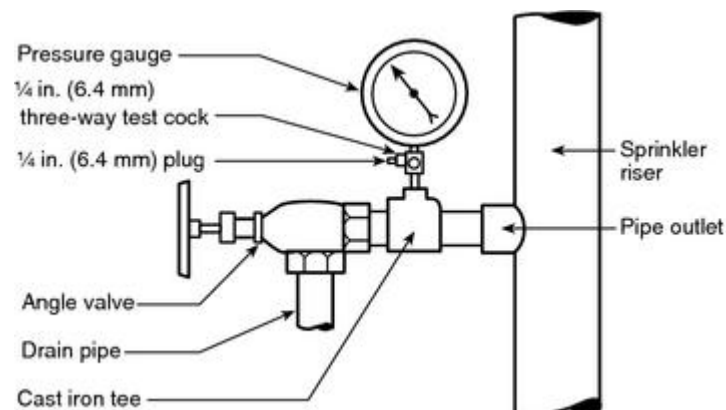

FIGURE A.8.16.2.4 Unacceptable Pressure Gauge Location.

A.8.16.2.4.1 Provisions should include vents at the top of drain risers in buildings more than six stories in height. An elbow near the top of the drain riser with a horizontal check valve facing in toward the system would be one acceptable arrangement. A check valve at the top of the drain riser would allow air into the drain riser and break any vacuum created by a standing column.

A.8.16.2.5.2.1 An example of an accessible location would be a valve located approximately 7 ft (2 m) above the floor level to which a hose could be connected to discharge the water in an acceptable manner.

A.8.16.2.6.1 Where possible, the main sprinkler riser drain should discharge outside the building at a point free from the possibility of causing water damage. Where it is not possible to discharge outside the building wall, the drain should be piped to a sump, which in turn should discharge by gravity or be pumped to a waste water drain or sewer. The main sprinkler riser drain connection should be of a size sufficient to carry off water from the fully open drain valve while it is discharging under normal water system pressures. Where this is not possible, a supplementary drain of equal size should be provided for test purposes with free discharge, located at or above grade.

A.8.16.4.2.1 Types of locations where corrosive conditions can exist include bleacheries, dye houses, metal plating processes, animal pens, and certain chemical plants.

If corrosive conditions are not of great intensity and humidity is not abnormally high, good results can be obtained by a protective coating of red lead and varnish or by a good grade of commercial acid-resisting paint. The paint manufacturer's instructions should be followed in the preparation of the surface and in the method of application.

Where moisture conditions are severe but corrosive conditions are not of great intensity, copper tube or galvanized steel pipe, fittings, and hangers might be suitable. The exposed threads of steel pipe should be painted.

In instances where the piping is not readily accessible and where the exposure to corrosive fumes is severe, either a protective coating of high quality can be employed or some form of corrosion-resistant material used.

A.8.17.1 Central station, auxiliary, remote station, or proprietary protective signaling systems are a highly desirable supplement to local alarms, especially from a safety to life standpoint. (See 8.17.1.6.)

Approved identification signs, as shown in Figure A.8.17.1, should be provided for outside alarm devices. The sign should be located near the device in a conspicuous position and should be worded as follows:

SPRINKLER FIRE ALARM — WHEN BELL RINGS

CALL FIRE DEPARTMENT OR POLICE.



FIGURE A.8.17.1 Identification Sign.

A.8.17.1.5 Water motor-operated devices should be located as near as practicable to the alarm valve, dry pipe valve, or other waterflow detecting device. The total length of the pipe to these devices should not exceed 75 ft (22.9 m), nor should the water motor-operated device be located over 20 ft (6.1 m) above the alarm device or dry pipe valve.

A.8.17.1.6 Monitoring should include but not be limited to control valves, building temperatures, fire pump power supplies and running conditions, and water tank levels and temperatures. Pressure supervision should also be provided on pressure tanks.

Check valves can be required to prevent false waterflow signals on floors where sprinklers have not activated — for example, floor systems interconnected to two supply risers.

A.8.17.2 The fire department connection should be located not less than 18 in. (457 mm) and not more than 4 ft (1.2 m) above the level of the adjacent grade or access level.

Typical fire department connections are shown in Figure A.8.17.2(a) and Figure A.8.17.2(b). See NFPA 13E, *Recommended Practice for Fire Department Operations in Properties Protected by Sprinkler and Standpipe Systems*.

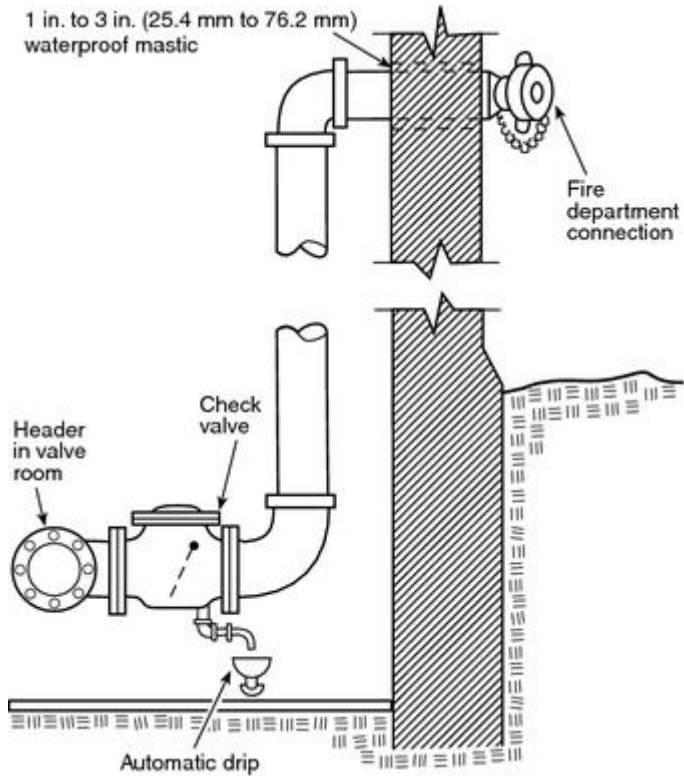
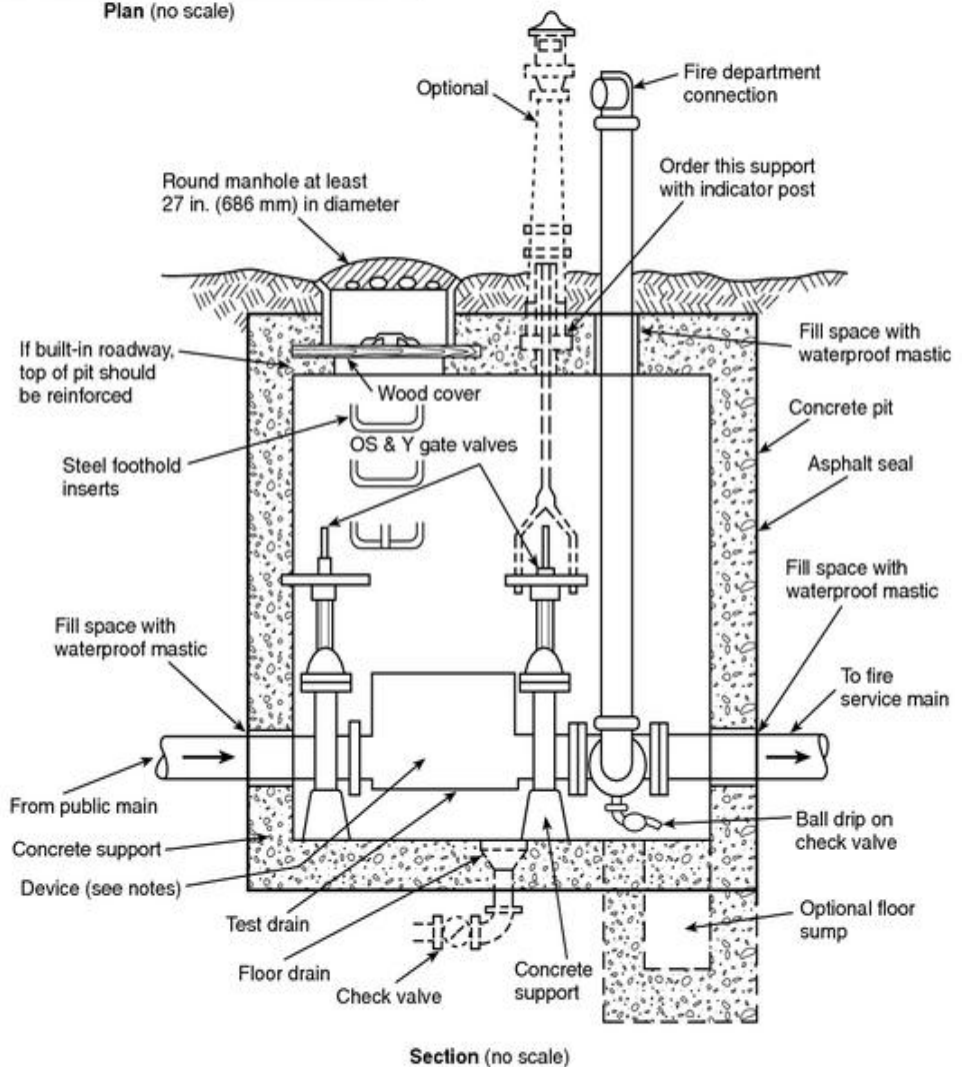
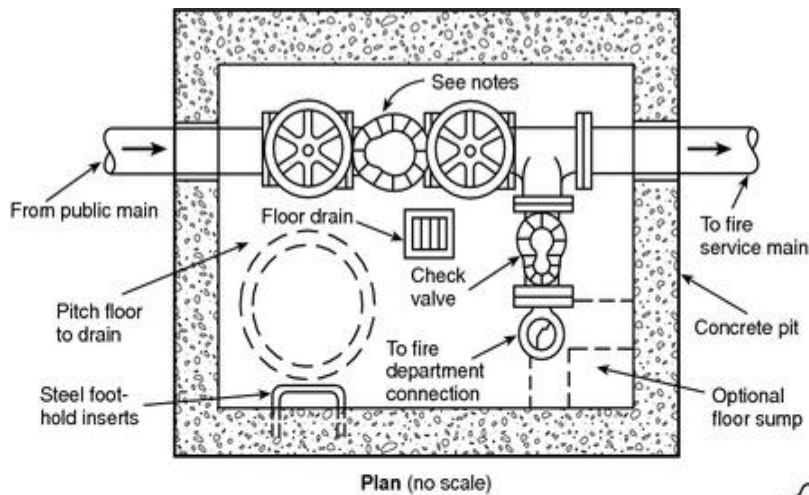

FIGURE A.8.17.2(a) Fire Department Connection.



- Notes:
1. Various backflow prevention regulations accept different devices at the connection between public water mains and private fire service mains.
 2. The device shown in the pit could be any or a combination of the following:

(a) Gravity check valve	(d) Reduced pressure zone (RPZ) device
(b) Detector check valve	(e) Vacuum breaker
(c) Double check valve assembly	
 3. Some backflow prevention regulations prohibit these devices from being installed in a pit.
 4. In all cases, the device(s) in the pit should be approved or listed as necessary. The requirements of the local or municipal water department should be reviewed prior to design or installation of the connection.
 5. Pressure drop should be considered prior to the installation of any backflow prevention devices.

FIGURE A.8.17.2(b) Typical City Water Pit — Valve Arrangement.

A.8.17.2.1 Fire department connections should be located and arranged so that hose lines can be readily and conveniently attached without interference from nearby objects, including buildings, fences, posts, or other fire department connections. Where a hydrant is not available, other water supply sources such as a natural body of water, a tank, or a reservoir should be utilized. The water authority should be consulted when a nonpotable water supply is proposed as a suction source for the fire department.

A.8.17.2.3 The purpose of a fire department connection is to supplement the pressure to an automatic fire sprinkler system. It is not the intent to size the FDC piping based on system demand. For multiple system risers supplied by a manifold, the fire department connection need not be larger than that for an individual system.

A.8.17.2.4 The check valve should be located to maximize accessibility and minimize freezing potential.

A.8.17.2.4.1 The fire department connection should be connected to the system riser. For single systems, it is an acceptable arrangement to attach the fire department connection to any point in the system, provided the pipe size meets the requirements of 8.17.2.3.

A.8.17.4.1 See Figure A.8.17.4.1.

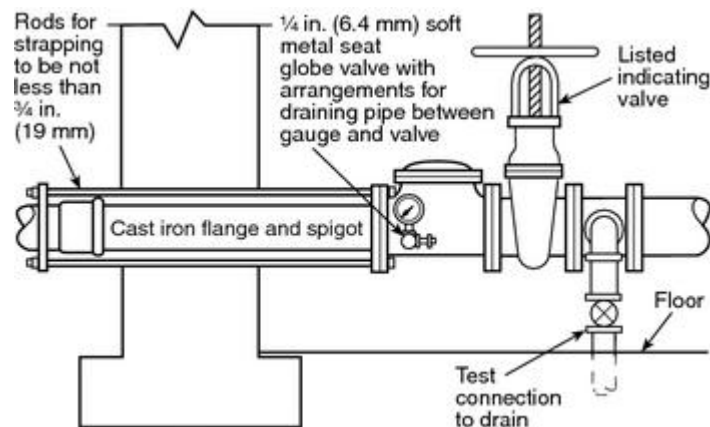

FIGURE A.8.17.4.1 Water Supply Connection with Test Connection.

A.8.17.4.2 The purpose of this alarm test connection is to make sure the alarm device is sensitive enough to determine the flow from a single sprinkler and sound an alarm. The purpose of this test connection is not to ensure that water will flow through the entire system.

When this test connection is installed on the upper story, and at the end of the most remote branch line, the user is able to tell that there is water flowing in one path through the system, but there is no assurance that water will flow to other branch lines. Putting the test connection at the most remote portion of the system causes the introduction of fresh oxygen into a large part of the system each time the alarm is tested and increases the corrosion that will occur in the piping.

The discharge should be at a point where it can be readily observed. In locations where it is

Copyright NFPA

not practical to terminate the test connection outside the building, the test connection is permitted to terminate into a drain capable of accepting full flow under system pressure. In this event, the test connection should be made using an approved sight test connection containing a smooth bore corrosion-resistant orifice giving a flow equivalent to one sprinkler simulating the least flow from an individual sprinkler in the system. [See Figure A.8.17.4.2(a) and Figure A.8.17.4.2(b).] The test valve should be located at an accessible point and preferably not over 7 ft (2.1 m) above the floor. The control valve on the test connection should be located at a point not exposed to freezing.

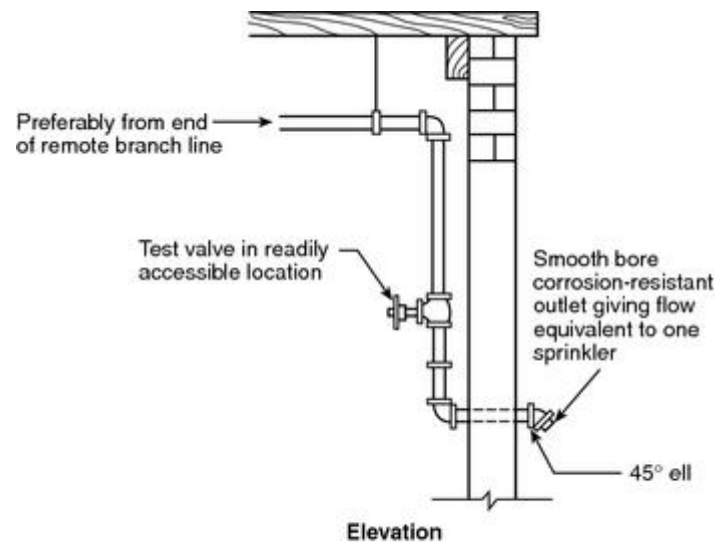

Note: Not less than 4 ft (1.2 m) of exposed test pipe in warm room beyond valve where pipe extends through wall to outside.

FIGURE A.8.17.4.2(a) System Test Connection on Wet Pipe System.

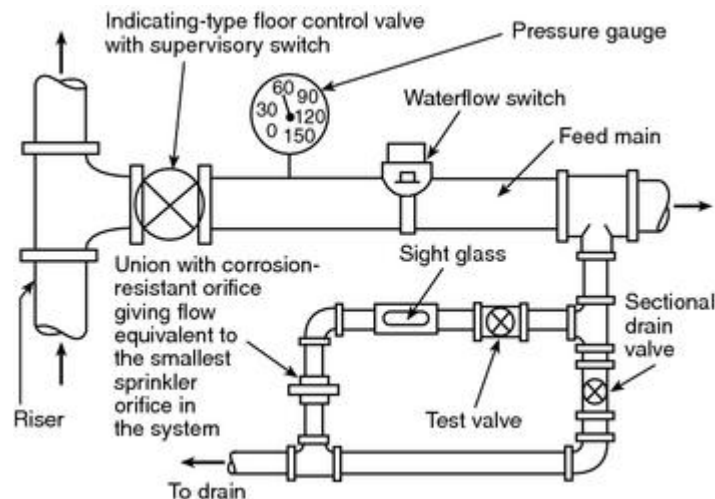

FIGURE A.8.17.4.2(b) Floor Control Valve.

A.8.17.4.3 See Figure A.8.17.4.3.

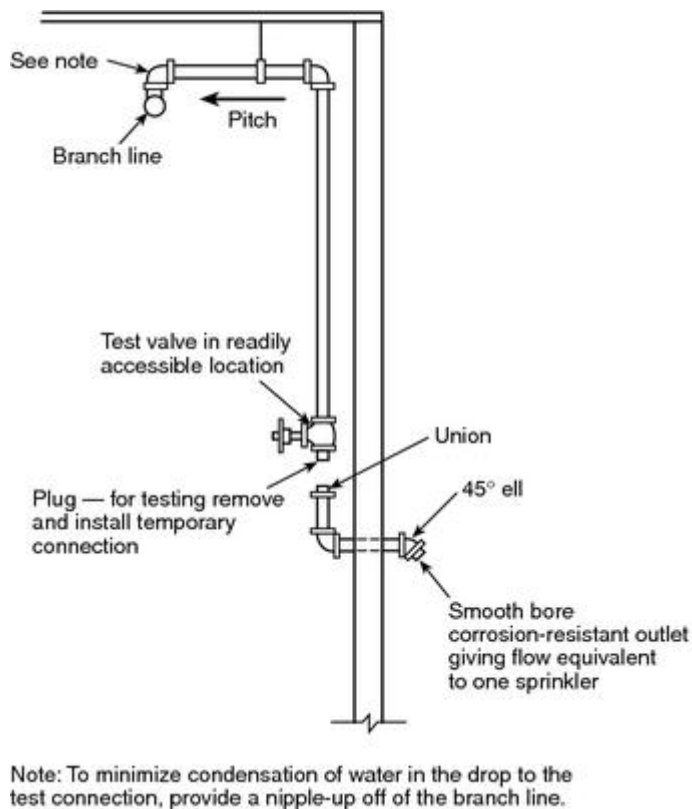

FIGURE A.8.17.4.3 System Test Connection on Dry Pipe System.

A.8.17.4.6 Where backflow prevention devices are installed, they should be in an accessible location to provide for service and maintenance.

A.8.17.4.6.1 The full flow test of the backflow prevention valve can be performed with a test header or other connection downstream of the valve. A bypass around the check valve in the fire department connector line with a control valve in the normally closed position can be an acceptable arrangement. When flow to a visible drain cannot be accomplished, closed loop flow can be acceptable if a flowmeter or site glass is incorporated into the system to ensure flow. When a backflow prevention device is retroactively installed on a pipe schedule system, the revised hydraulic calculation still follows the pipe schedule method of 11.2.2 with the inclusion of friction loss for the device.

A.8.17.5.1.1 One and one-half inch (40 mm) fire hose packs are not required unless designated by the AHJ, as it is not likely that such hoses will be adequately maintained for safe use by first responders. Civilian workers who are not properly trained in fire-fighting techniques are expected to evacuate the building in the event of a fire.

A.8.17.5.1.4 This standard covers 1½ in. (38 mm) hose connections for use in storage occupancies and other locations where standpipe systems are not required. Where Class II standpipe systems are required, see the appropriate provisions of NFPA 14, *Standard for the Installation of Standpipe and Hose Systems*, with respect to hose stations and water supply for hose connections from sprinkler systems.

A.8.17.5.2.2 See Figure A.8.17.5.2.2(a) and Figure A.8.17.5.2.2(b).

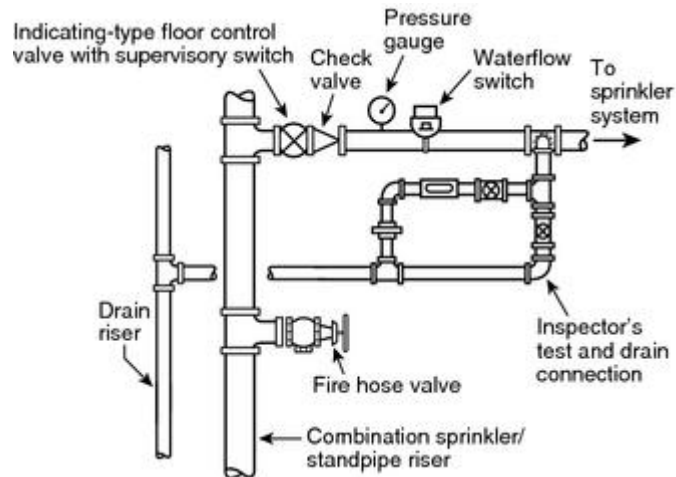

FIGURE A.8.17.5.2.2(a) Acceptable Piping Arrangement for Combined Sprinkler/Standpipe System. [14:Figure A.7.10.1.3.1(a)]

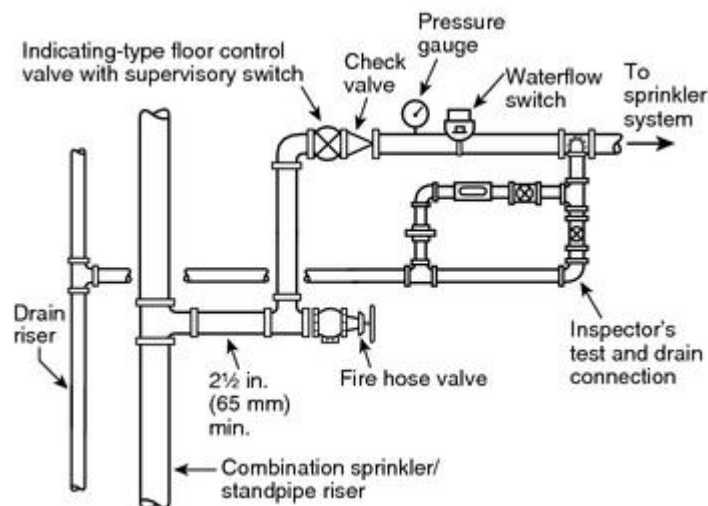

FIGURE A.8.17.5.2.2(b) Acceptable Piping Arrangement for Combined Sprinkler/Standpipe System. [14:Figure A.7.10.1.3.1(b)]

A.9.1.1 See Figure A.9.1.1. As an alternative to the conventional method of hanging pipe from the structure using attachments and rod, the piping can be simply laid on the structural member, provided the structure can adequately support the added load in accordance with 9.2.1.3.1 and the maximum distance between supports as required by Chapter 9 is not exceeded. Listed pipe should still be installed and supported in accordance with its listing limitations.

To prevent pipe movement, it should be secured with an approved device to the structure and located to ensure that the system piping remains in its original location and position.



Adjustable swivel ring



Clevis hanger



Split ring

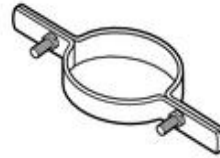

Riser clamp



Pipe clamp

Ceiling flanges



Side beam attachments



Eyelet



Offset eyelet

C-type clamps

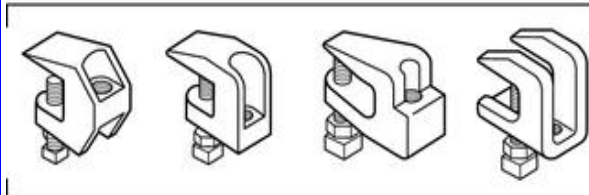

Universal beam clamps



Wide mouth beam clamp



Purlin clamp



Steel C-clamp



Malleable iron C-clamp

Concrete inserts



Retainer strap

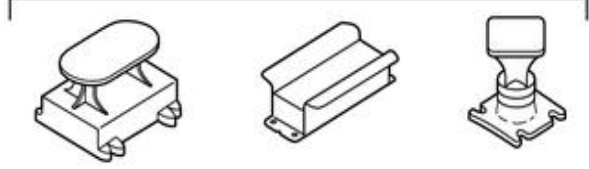

Toggle nut

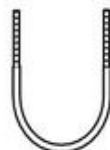

U-bolt



U-hook



Wraparound U-hook



Short strap

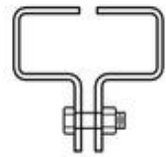

Wood beam clamp

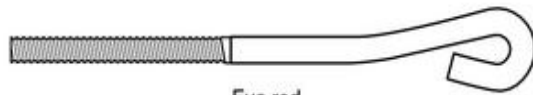

Eye rod



Rod coupling



Coach screw rod

Post-installed anchors



Wedge anchor



Drop in

Powder-driven



Concrete



Steel



All thread rod



Lag screw

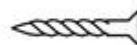

Drive screw



Wood screw

FIGURE A.9.1.1 Common Types of Acceptable Hangers.

A.9.1.1.4.2 Generic items utilized with hanger rods and fasteners are not required to be listed. These include such items as bolts, screws, washers, nuts and lock nuts.

A.9.1.1.4.3 Generic items utilized with hanger rods and fasteners are not required to be listed. These include such items as bolts, screws, washers, nuts and lock nuts.

A.9.1.1.6 Table 9.1.1.6.1(a) assumes that the load from 15 ft (5 m) of water-filled pipe, plus 250 lb (114 kg), is located at the midpoint of the span of the trapeze member, with a maximum allowable bending stress of 15 ksi (111 kg). If the load is applied at other than the midpoint, for the purpose of sizing the trapeze member, an equivalent length of trapeze can be used, derived from the following formula:

$$L = \frac{4ab}{a+b}$$

where:

L = equivalent length

a = distance from one support to the load

b = distance from the other support to the load

Where multiple mains are to be supported or multiple trapeze hangers are provided in parallel, the required or available section modulus can be added.

A.9.1.1.6.5 Hanger components are sized based upon an ultimate strength limit of 5 times the weight of water-filled pipe plus 250 lb (114 kg). The section moduli used to size the trapeze member are based on a maximum bending stress, which provides an acceptable level of safety that is comparable to that of the other hanger components.

A.9.1.1.7 The rules covering the hanging of sprinkler piping take into consideration the weight of water-filled pipe plus a safety factor. No allowance has been made for the hanging of nonsystem components from sprinkler piping. NFPA 13 provides the option to support sprinkler piping from other sprinkler piping where the requirements of 9.1.1.2 are met.

A.9.1.2.3 Hanger rods are intended only to be loaded axially (along the rod). Lateral loads can result in bending, weakening, and even breaking of the rod. Additional hangers or restraints could be necessary to eliminate non-axial loads that could induce bending or deflection of the rods. See Figure A.9.1.2.3 for an example of additional hangers utilized to eliminate non-axial loads.

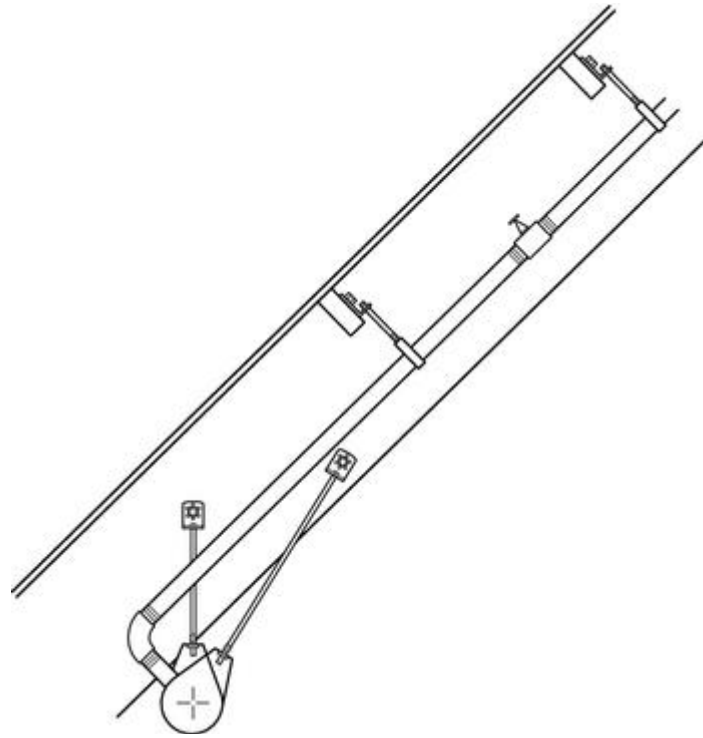

FIGURE A.9.1.2.3 Example of Additional Hangers Utilized to Eliminate Non-Axial Loads.

A.9.1.3.9.3 The ability of concrete to hold the studs varies widely according to type of aggregate, quality of concrete, and proper installation.

A.9.1.4.1 Powder-driven studs should not be used in steel of less than $\frac{3}{16}$ in. (4.8 mm) total thickness.

A.9.2 Proper hanger installation is important. Installation procedures should meet industry standards of practice and craftsmanship. Examples: hanger assemblies that are straight, perpendicular to the pipe, uniformly located, snug to the structure with fasteners fully engaged.

A.9.2.1.3 The method used to attach the hanger to the structure and the load placed on the hanger should take into account any limits imposed by the structure. Design manual information for pre-engineered structures or other specialty construction materials should be consulted, if appropriate.

System mains hung to a single beam, truss, or purlin can affect the structural integrity of the building by introducing excessive loads not anticipated in the building design. Also, special conditions such as collateral and concentrated load limits, type or method of attachment to the structural components, or location of attachment to the structural components might need to be observed when hanging system piping in pre-engineered metal buildings or buildings using other specialty structural components such as composite wood joists or combination wood and tubular metal joists.

The building structure is only required to handle the weight of the water-filled pipe and

components, while the hangers are required to handle 5 times the weight of the water-filled pipe. In addition, a safety factor load of 250 lb (114 kg) is added in both cases. The difference in requirements has to do with the different ways that loads are calculated and safety factors are applied.

When sprinkler system loads are given to structural engineers for calculation of the structural elements in the building, they apply their own safety factors in order to determine what structural members and hanging locations will be acceptable.

In contrast, when sprinkler system loads are calculated for the hangers themselves, there is no explicit safety factor, so NFPA 13 mandates a safety factor of 5 times the weight of the pipe.

A.9.2.1.3.3 Examples of areas of use include cleanrooms, suspended ceilings, and exhaust ducts.

A.9.2.1.3.3.3 The committee evaluation of flexible sprinkler hose fittings supported by suspended ceilings was based on a comparison of the weight of a 6 ft, 1 in. diameter Schedule 40 water-filled unsupported armover weighing approximately 13 lb to the weight of a 6 ft, 1 in diameter water-filled flexible hose fitting weighing approximately 9 lb. The information provided to the committee showed that the maximum load shed to the suspended ceiling by the flexible hose fitting was approximately 6 lb and that a suspended ceiling meeting ASTM C 635, *Standard Specification for the Manufacture, Performance, and Testing of Metal Suspension Systems of Acoustical Tile and Lay-In Panel Ceilings*, and installed in accordance with ASTM C 636, *Standard Practice for Installation of Metal Ceiling Suspension Systems for Acoustical Tile and Lay-In Panels*, can substantially support that load. In addition, the supporting material showed that the flexible hose connection can be attached to the suspended ceilings because it allows the necessary deflections under seismic conditions.

A.9.2.1.4.1 The requirements of 9.2.1.4.1 are based on metal decks only but can be applied to other applications such as concrete or gypsum-filled metal decks.

A.9.2.2 Where copper tube is to be installed in moist areas or other environments conducive to galvanic corrosion, copper hangers or ferrous hangers with an insulating material should be used.

A.9.2.3.2 The hangers required by Chapter 9 are intended to accommodate general loading such as check valves, control valves, or dry or deluge valves. Where additional equipment such as backflow prevention assemblies and other devices with substantial loads are added, additional hangers should be considered.

A.9.2.3.2.2 See Figure A.9.2.3.2.2.

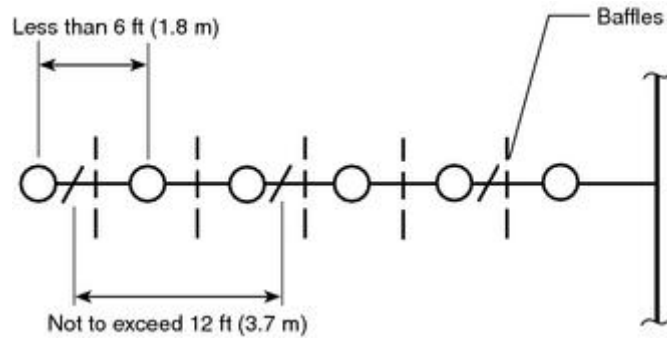

FIGURE A.9.2.3.2 Distance Between Hangers.

A.9.2.3.2.3 The “starter length” is the first piece of pipe on a branch line between the main, riser nipple, or drop and the first sprinkler. Starter pieces that are less than 6 ft (1.83 m) in length do not need a hanger of their own because they are supported by the main. However, if the intermediate hanger on the main is omitted, the starter piece needs to have a hanger because the main is going to be supported from the branch lines.

A.9.2.3.4 Sprinkler piping should be adequately secured to restrict the movement of piping upon sprinkler operation. The reaction forces caused by the flow of water through the sprinkler could result in displacement of the sprinkler, thereby adversely affecting sprinkler discharge. Listed CPVC pipe and listed polybutylene pipe have specific requirements for piping support to include additional pipe bracing of sprinklers. See Figure A.9.2.3.4.

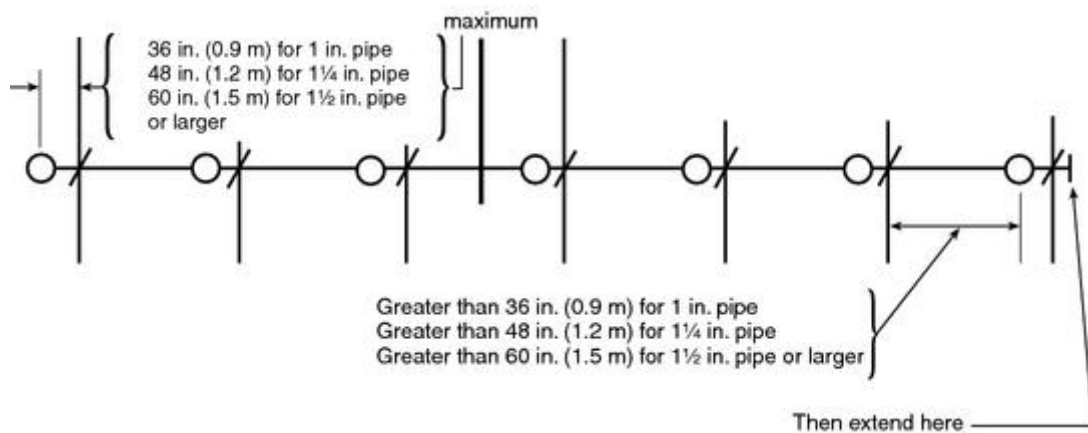

FIGURE A.9.2.3.4 Distance from Sprinkler to Hanger.

A.9.2.3.4.4 See Figure A.9.2.3.4.4(a) and Figure A.9.2.3.4.4(b).

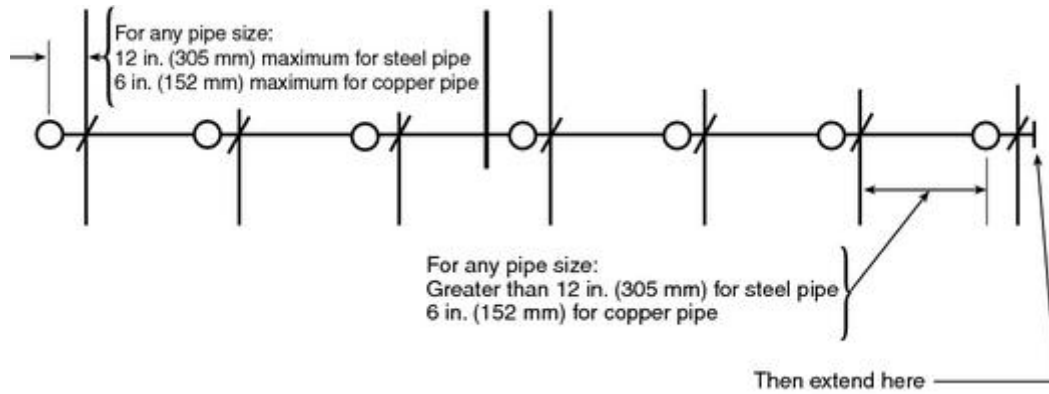

FIGURE A.9.2.3.4.4(a) Distance from Sprinkler to Hanger Where Maximum Pressure Exceeds 100 psi (6.9 bar) and a Branch Line Above a Ceiling Supplies Pendent Sprinklers Below the Ceiling.

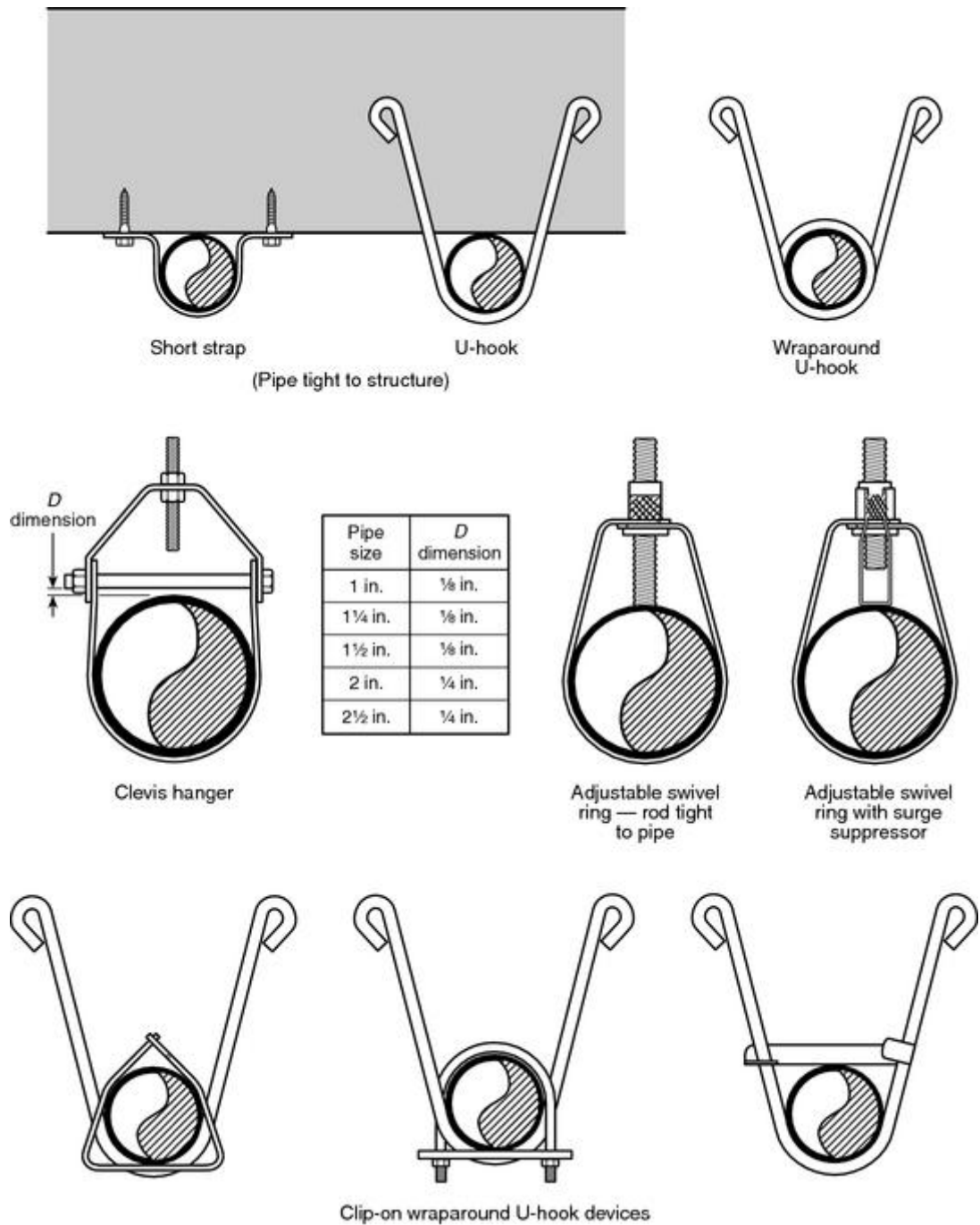

FIGURE A.9.2.3.4(b) Examples of Acceptable Hangers for End-of-Line (or Armover) Pendent Sprinklers.

A.9.2.3.5 See Figure A.9.2.3.5.

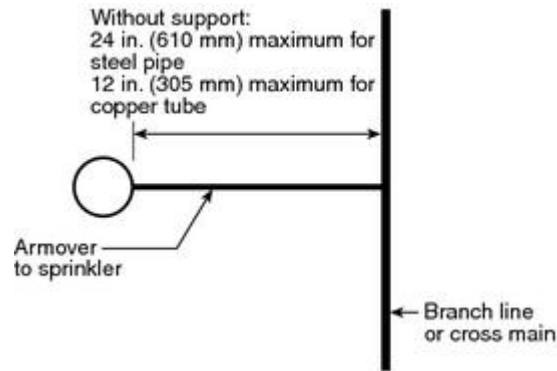
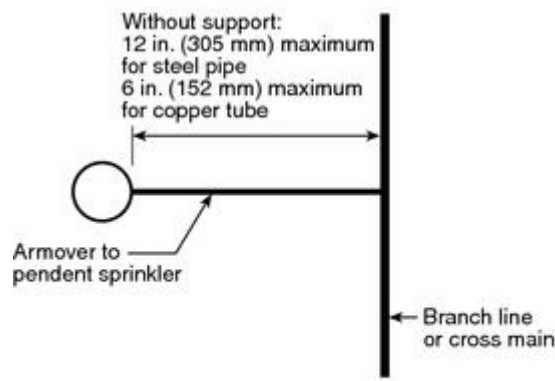

FIGURE A.9.2.3.5 Maximum Length for Unsupported Armovert.

A.9.2.3.5.2 See Figure A.9.2.3.5.2.



Note: The pendent sprinkler can be installed either directly in the fitting at the end of the armover or in a fitting at the bottom of a drop nipple.

FIGURE A.9.2.3.5.2 Maximum Length of Unsupported Armovert Where the Maximum Pressure Exceeds 100 psi (6.9 bar) and a Branch Line Above a Ceiling Supplies Pendent Sprinklers Below the Ceiling.

A.9.2.5.3 This arrangement is acceptable to establish and secure the riser's lateral position but not to support the riser's vertical load.

A.9.2.5.4.2 The restraint required by 9.2.5.4.2 is needed to prevent accumulated vertical movement when the riser is pressurized. Restraint is generally provided by use of a riser clamp at the underside of a floor slab.

A.9.2.6 Examples include headers and horizontal runs of pipe that need support from the floor.

A.9.3.1 Sprinkler systems are protected against earthquake damage by means of the following:

- (1) Stresses that would develop in the piping due to differential building movement are minimized through the use of flexible joints or clearances.
- (2) Bracing is used to keep the piping fairly rigid when supported from a building

component expected to move as a unit, such as a ceiling.

Areas known to have a potential for earthquakes have been identified in building code and insurance maps.

A.9.3.2 Strains on sprinkler piping can be greatly lessened and, in many cases, damage prevented by increasing the flexibility between major parts of the sprinkler system. One part of the piping should never be held rigidly and another part allowed to move freely without provision for relieving the strain. Flexibility can be provided by using listed flexible couplings, by joining grooved end pipe at critical points, and by allowing clearances at walls and floors.

Tank or pump risers should be treated the same as sprinkler risers for their portion within a building. The discharge pipe of tanks on buildings should have a control valve above the roof line so any pipe break within the building can be controlled.

Piping 2 in. (51 mm) or smaller in size is pliable enough so that flexible couplings are not usually necessary. “Rigid-type” couplings that permit less than 1 degree of angular movement at the grooved connections are not considered to be flexible couplings. [See Figure A.9.3.2(a) and Figure A.9.3.2(b).]

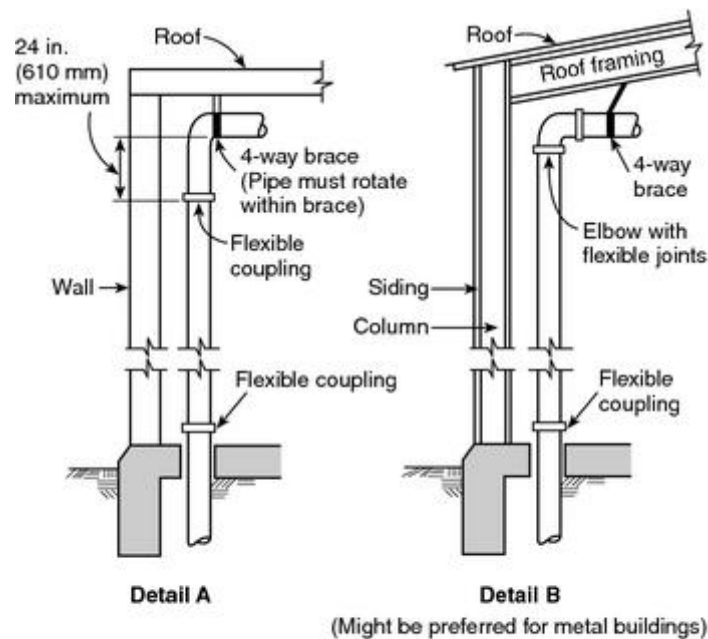

Note to Detail A: The four-way brace should be attached above the upper flexible coupling required for the riser and preferably to the roof structure if suitable. The brace should not be attached directly to a plywood or metal deck.

FIGURE A.9.3.2(a) Riser Details.

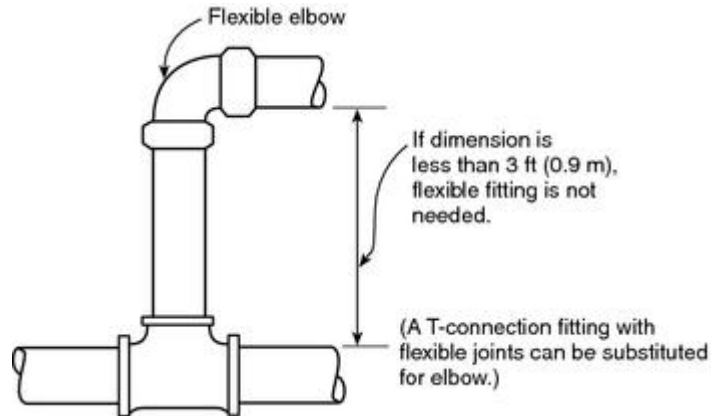

FIGURE A.9.3.2(b) Detail at Short Riser.

A.9.3.2.3(2)(a) See Figure A.9.3.2.3(2)(a).

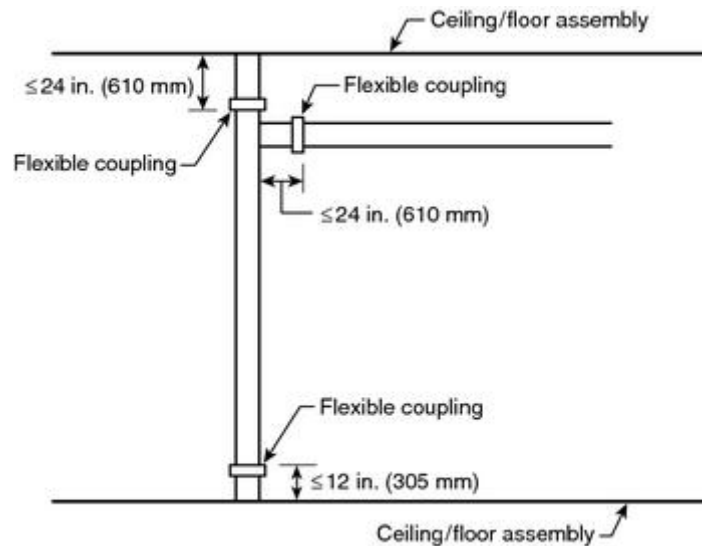

FIGURE A.9.3.2.3(2)(a) Flexible Coupling on Horizontal Portion of Tie-In.

A.9.3.2.3(2)(b) The flexible coupling should be at the same elevation as the flexible coupling on the main riser. [See Figure A.9.3.2.3(2)(b).]

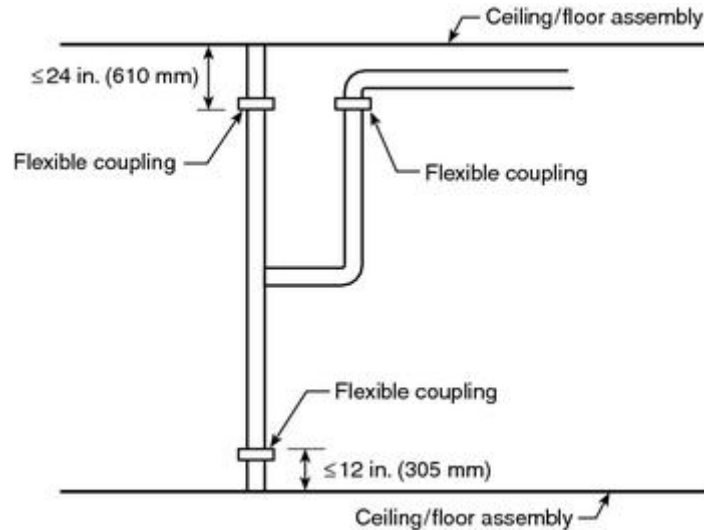

FIGURE A.9.3.2.3(2)(b) Flexible Coupling on Main Riser and Branch Line Riser.

A.9.3.2.3(4) A building expansion joint is usually a bituminous fiber strip used to separate blocks or units of concrete to prevent cracking due to expansion as a result of temperature changes. Where building expansion joints are used, the flexible coupling is required on one side of the joint by 9.3.2.3(4).

For seismic separation joints, considerably more flexibility is needed, particularly for piping above the first floor. Figure A.9.3.3(a) shows a method of providing additional flexibility through the use of swing joints.

A.9.3.2.4 See Figure A.9.3.2.4.

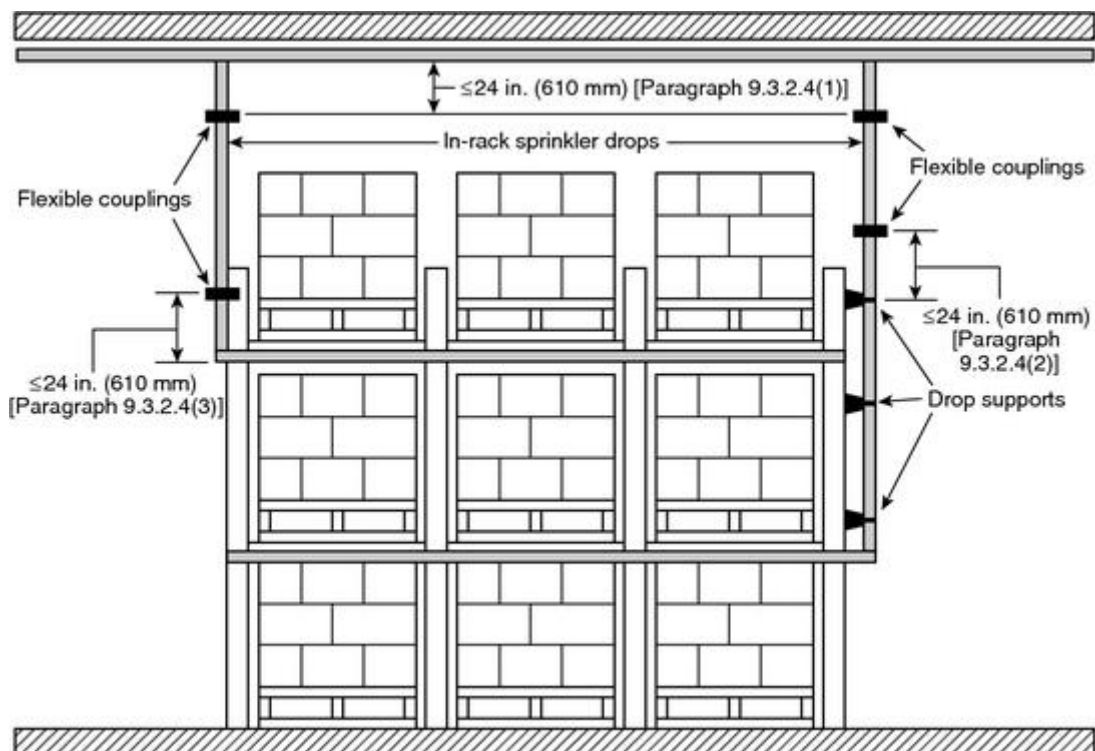

FIGURE A.9.3.2.4 Flexible Couplings for Drops.

A.9.3.3 Plan and elevation views of a seismic separation assembly configured with flexible elbows are shown in Figure A.9.3.3(a) or Figure A.9.3.3(b).

A seismic separation assembly is considered to be an assembly of fittings, pipe, and couplings or an assembly of pipe and couplings that permits movement in all directions. The extent of permitted movement should be sufficient to accommodate calculated differential motions during earthquakes. In lieu of calculations, permitted movement can be made at least twice the actual separations, at right angles to the separation as well as parallel to it.

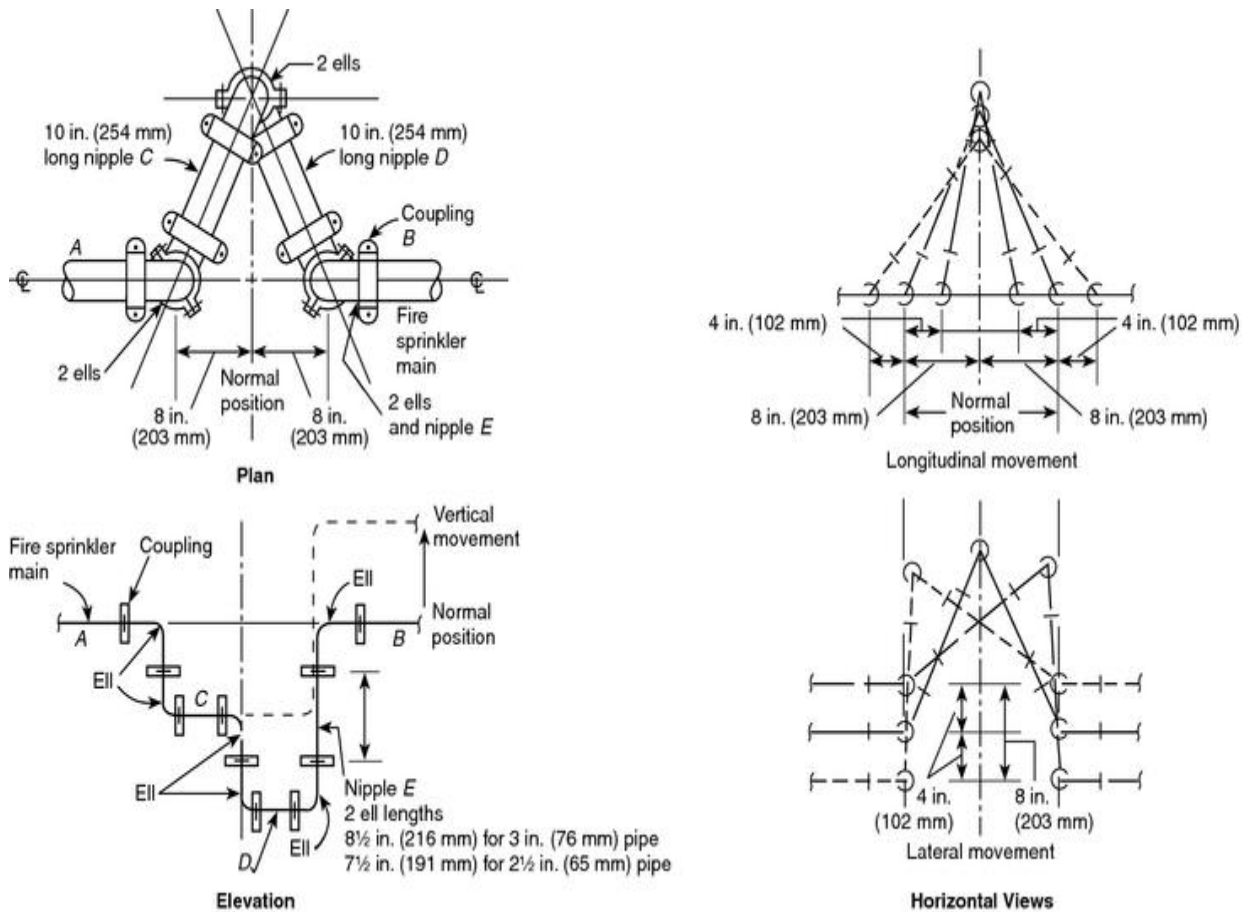

FIGURE A.9.3.3(a) Seismic Separation Assembly. Shown are an 8 in. (203 mm) Separation Crossed by Pipes up to 4 in. (102 mm) in Nominal Diameter. For other separation distances and pipe sizes, lengths and distances should be modified proportionally.

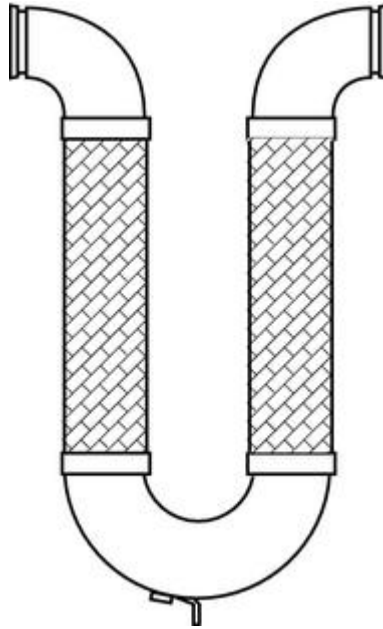

FIGURE A.9.3.3(b) Seismic Separation Assembly Incorporating Flexible Piping.

A.9.3.3.3 Each four-way brace should be attached to the building structure on opposite sides of the seismic separation joint.

A.9.3.4 While clearances are necessary around the sprinkler piping to prevent breakage due to building movement, suitable provision should also be made to prevent passage of water, smoke, or fire.

Drains, fire department connections, and other auxiliary piping connected to risers should not be cemented into walls or floors; similarly, pipes that pass horizontally through walls or foundations should not be cemented solidly or strains will accumulate at such points.

Where risers or lengths of pipe extend through suspended ceilings, they should not be fastened to the ceiling framing members.

A.9.3.5 Figure A.9.3.5(a) and Figure A.9.3.5(b) are examples of forms used to aid in the preparation of bracing calculations.

Seismic Bracing Calculations

Sheet _____ of _____

Project: _____
 Address: _____

Contractor: _____
 Address: _____

 Telephone: _____
 Fax: _____

Brace Information

Length of brace: _____
 Diameter of brace: _____
 Type of brace: _____
 Angle of brace: _____
 Least radius of gyration:* _____
 L/R value:* _____
 Maximum horizontal load: _____

Seismic Brace Attachments

Structure attachment fitting or tension-only bracing system:
 Make: _____ Model: _____
 Listed load rating: _____ Adjusted load rating per 9.3.5.10.3: _____
 Sway brace (pipe attachment) fitting:
 Make: _____ Model: _____
 Listed load rating: _____ Adjusted load rating per 9.3.5.10.3: _____

Seismic Brace Assembly Detail (Provide detail on plans)

Fastener Information

Orientation of connecting surface: _____
 Fastener:
 Type: _____
 Diameter: _____
 Length (in wood): _____
 Maximum load: _____

Brace identification no.
 (to be used on plans) _____

Lateral brace Longitudinal brace

Sprinkler System Load Calculation [$F_p = \text{_____ } W_p$ (default is 0.5)]

Diameter	Type	Length (ft)	Total (ft)	Weight per ft	Total Weight
				lb/ft	lb
				lb/ft	lb
				lb/ft	lb
				lb/ft	lb
				lb/ft	lb
				Total weight	lb
				$F_p \times 1.15$	lb

* Excludes tension-only bracing systems

FIGURE A.9.3.5(a) Seismic Bracing Calculation Form.

Seismic Bracing Calculations

Sheet _____ of _____

Project: Acme Warehouse
 Address: 321 First Street
Any City, Any State

Contractor: Smith Sprinkler Company
 Address: 123 Main Street
Any City, Any State
 Telephone: (555) 555-1234
 Fax: (555) 555-4321

Brace Information

Length of brace: 6 ft 8 in.
 Diameter of brace: 1 in.
 Type of brace: Schedule 40
 Angle of brace: 30° to 45°
 Least radius of gyration:* 0.42
 L/R value:* 200
 Maximum horizontal load: 1767 lb

Seismic Brace Attachments

Structure attachment fitting or tension-only bracing system:
 Make: Acme Model: 123
 Listed load rating: 1000 Adjusted load rating per 9.3.5.10.3: 500
 Sway brace (pipe attachment) fitting:
 Make: Acme Model: 321
 Listed load rating: 1200 Adjusted load rating per 9.3.5.10.3: 600

Fastener Information

Orientation of connecting surface: "D"
 Fastener:
 Type: Through bolt
 Diameter: 5/8 in.
 Length (in wood): 3 5/8 in.
 Maximum load: 491 lb

Seismic Brace Assembly Detail (Provide detail on plans)

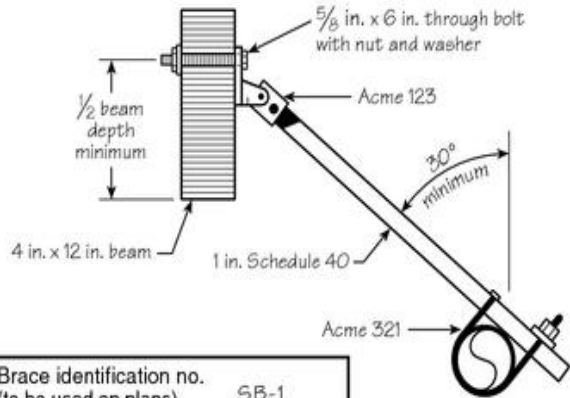

Brace identification no. (to be used on plans) SB-1

Lateral brace Longitudinal brace

Sprinkler System Load Calculation [$F_p = \underline{\quad} W_p$ (default is 0.5)]

Diameter	Type	Length (ft)	Total (ft)	Weight per ft	W_p	Total Weight
1 in.	Sch 40	15 ft + 25 ft + 8 ft + 22 ft	70 ft	2.05 lb/ft	0.5	71.75 lb
1 1/4 in.	Sch 40	25 ft + 33 ft + 18 ft	76 ft	2.93 lb/ft	0.5	111.34 lb
1 1/2 in.	Sch 40	8 ft + 8 ft + 10 ft + 10 ft	36 ft	3.61 lb/ft	0.5	64.98 lb
2 in.	Sch 40	20 ft	20 ft	5.13 lb/ft	0.5	51.3 lb
4 in.	Sch 10	20 ft	20 ft	11.78 lb/ft	0.5	117.8 lb
Total weight						417.17 lb
$F_p \times 1.15$						480 lb

* Excludes tension-only bracing systems

© 2006 National Fire Protection Association

NFPA 13 (p. 2 of 2)

FIGURE A.9.3.5(b) Sample Seismic Bracing Calculation.

A.9.3.5.1.3 All horizontal loads given in this document are at allowable stress design levels. When performing a more advanced analysis procedure, as described in 9.3.1.2, care should be taken to ensure that the correct load factors (strength design or allowable stress design) are used.

A.9.3.5.2.2 The investigation of tension-only bracing using materials, connection methods, or both, other than those described in Table 9.3.5.8.8(a), Table 9.3.5.8.8(b), and Table 9.3.5.8.8(c), should involve consideration of the following:

- (1) Corrosion resistance.
- (2) Prestretching to eliminate permanent construction stretch and to obtain a verifiable modulus of elasticity.
- (3) Color coding or other verifiable marking of each different size cable for field verification.
- (4) The capacity of all components of the brace assemblies, including the field connections, to maintain the manufacturer's minimum certified break strength.
- (5) Manufacturer's published design data sheets/manual showing product design guidelines, including connection details, load calculation procedures for sizing of braces, and the maximum recommended horizontal load-carrying capacity of the brace assemblies including the associated fasteners as described in Figure 9.3.5.9.1. The maximum allowable horizontal loads must not exceed the manufacturer's minimum certified break strength of the brace assemblies, excluding fasteners, after taking a safety factor of 1.5 and then adjusting for the brace angle.
- (6) Brace product shipments accompanied by the manufacturer's certification of the minimum break strength and prestretching and installation instructions.
- (7) The manufacturer's literature, including any special tools or precautions required to ensure proper installation.
- (8) A means to prevent vertical motion due to seismic forces when required.

Table A.9.3.5.2.2 identifies some specially listed tension-only bracing systems.

**Table A.9.3.5.2.2 Specially Listed
Tension-Only Seismic Bracing**

Materials and Dimensions	Standard
Manual for Structural Application of Steel Cables	ASCE 19-96
Wire Rope Users Manual of the Wire Rope Technical Board	ASCE 19-96
Mechanical Strength Requirements	ASTM A 603

**Table A.9.3.5.2.2 Specially Listed
Tension-Only Seismic Bracing**

Materials and Dimensions	Standard
Breaking Strength Failure Testing	ASTM E 8

A.9.3.5.3.1 A brace assembly includes the brace member, the attachment components to pipe and building, and their fasteners. There are primarily two considerations in determining the spacing of lateral earthquake braces in straight runs of pipe: (1) deflection and (2) stress. Both deflection and stress tend to increase with the spacing of the braces. The larger the mid-span deflection, the greater the chance of impact with adjacent structural/nonstructural components. The higher the stress in the pipe, the greater the chance of rupture in the pipe or coupling. Braces are spaced to limit the stresses in the pipe and fittings to the levels permitted in modern building codes, with an upper limit of 40 ft (12.2 m). The braces also serve to control deflection of the pipe under earthquake loads. In the longitudinal direction, there is no deflection consideration, but the pipe must transfer the load to the longitudinal braces without inducing large axial stresses in the pipe and the couplings.

A.9.3.5.3.2 The sway brace spacings in Table 9.3.5.3.2(a) and Table 9.3.5.3.2(b) were developed to allow designers to continue to use familiar concepts, such as zone of influence, to lay out and proportion braces while ensuring compatibility with modern seismic requirements. The spacing of braces was determined using the provisions of ASCE 7, *Minimum Design Loads for Buildings and Other Structures*, assuming steel pipe with threaded or grooved connections. The tabulated values are based on conservative simplifying assumptions. A detailed engineering analysis, taking into account the properties of the specific system, might provide greater spacing. However, in order to control deflections, in no case should the lateral sway brace spacing exceed 40 ft (12.2 m).

A.9.3.5.5.1 The four-way brace provided at the riser can also provide longitudinal and lateral bracing for adjacent mains.

A.9.3.5.6 *Location of Sway Bracing.* Two-way braces are either longitudinal or lateral, depending on their orientation with the axis of the piping. [See Figure A.9.3.5.6(a), Figure A.9.3.5.6(b), Figure A.9.3.5.6(c), and Figure A.9.3.5.6(d).] The simplest form of two-way brace is a piece of steel pipe or angle. Because the brace must act in both compression and tension, it is necessary to size the brace to prevent buckling.

An important aspect of sway bracing is its location. In Building 1 of Figure A.9.3.5.6(a), the relatively heavy main will pull on the branch lines when shaking occurs. If the branch lines are held rigidly to the roof or floor above, the fittings can fracture due to the induced stresses. In selecting brace locations, one must consider both the design load on the brace, as well as the ability of the pipe to span between brace locations.

Bracing should be on the main as indicated at Location B. With shaking in the direction of the arrows, the light branch lines will be held at the fittings. Where necessary, a lateral brace or other restraint should be installed to prevent a branch line from striking against building

components or equipment.

A four-way brace is indicated at Location A. This keeps the riser and main lined up and also prevents the main from shifting.

In Building 1, the branch lines are flexible in a direction parallel to the main, regardless of building movement. The heavy main cannot shift under the roof or floor, and it also steadies the branch lines. While the main is braced, the flexible couplings on the riser allow the sprinkler system to move with the floor or roof above, relative to the floor below.

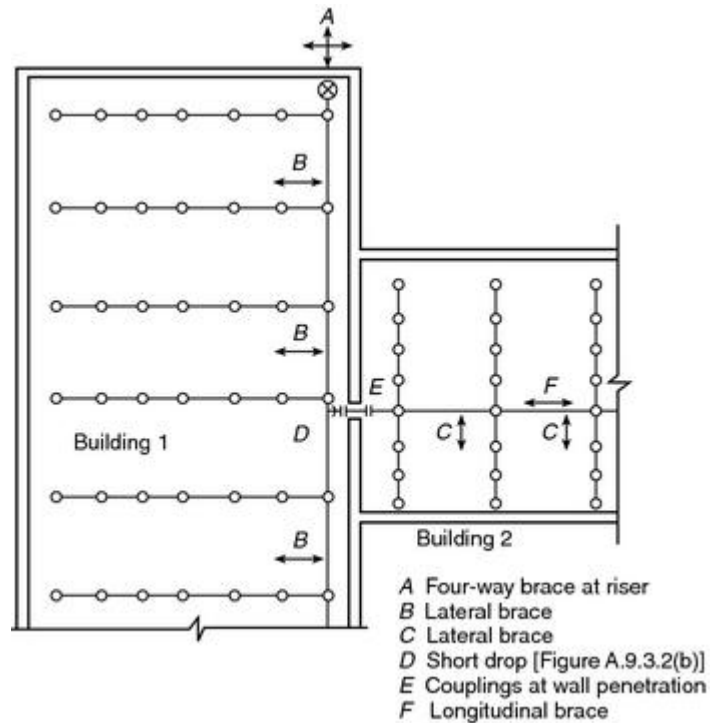

FIGURE A.9.3.5.6(a) Earthquake Protection for Sprinkler Piping.

Figure A.9.3.5.6(b), Figure A.9.3.5.6(c), and Figure A.9.3.5.6(d) show typical locations of sway bracing.

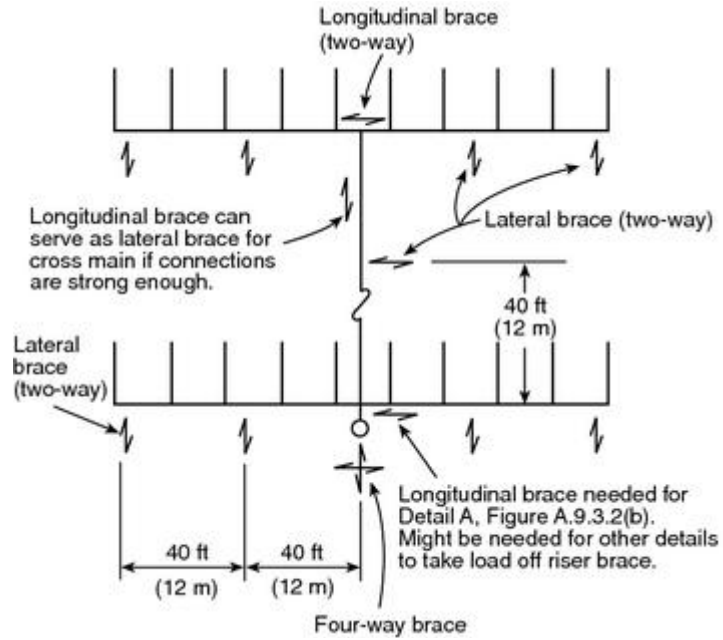

FIGURE A.9.3.5.6(b) Typical Location of Bracing on a Tree System.

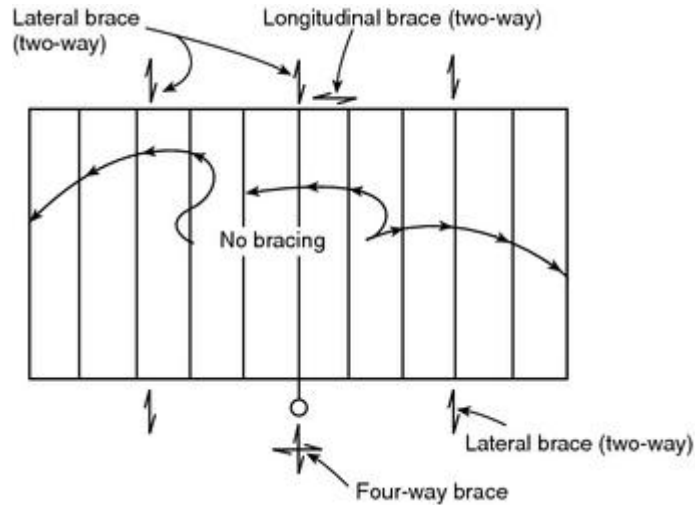

FIGURE A.9.3.5.6(c) Typical Location of Bracing on a Gridded System.

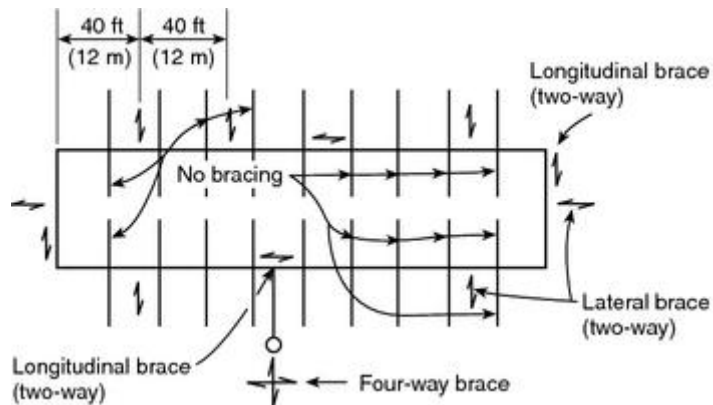

FIGURE A.9.3.5.6(d) Typical Location of Bracing on a Looped System.

For all threaded connections, sight holes or other means should be provided to permit indication that sufficient thread is engaged.

To properly size and space braces, it is necessary to employ the following steps:

- (1) Determine the seismic coefficient, C_p , using the procedures in 9.3.5.6.2. This is needed by the designer to verify that the piping can span between brace points. For the purposes of this example, assume that $C_p = 0.5$.
- (2) Based on the distance of mains from the structural members that will support the braces, choose brace shapes and sizes from Table 9.3.5.8.8(a), Table 9.3.5.8.8(b), and Table 9.3.5.8.8(c) such that the maximum slenderness ratios, l/r , do not exceed 300. The angle of the braces from the vertical should be at least 30 degrees and preferably 45 degrees or more.
- (3) Tentatively space lateral braces at 40 ft (12 m) maximum distances along mains and tentatively space longitudinal braces at 80 ft (24 m) maximum distances along mains. Lateral braces should meet the piping at right angles, and longitudinal braces should be aligned with the piping.
- (4) Determine the total load tentatively applied to each brace in accordance with the examples shown in Figure A.9.3.5.6(e) and the following:
 - (a) For the loads on lateral braces on cross mains, add C_p times the weight of the branch to C_p times the weight of the portion of the cross main within the zone of influence of the brace. [See examples 1, 3, 6, and 7 in Figure A.9.3.5.6(e).]
 - (b) For the loads on longitudinal braces on cross mains, consider only C_p times the weight of the cross mains and feed mains within the zone of influence. Branch lines need not be included. [See examples 2, 4, 5, 7, and 8 in Figure A.9.3.5.6(e).] For the four-way bracing at the top of the riser, C_p times the weight of the riser should be assigned to both of the lateral and longitudinal loads as they are separately considered.
 - (c) For the four-way brace at the riser, add the longitudinal and lateral loads within the zone of influence of the brace [see examples 2, 3, and 5 in Figure A.9.3.5.6(e)]. For the four-way bracing at the top of the riser, C_p times the weight of the riser should be assigned to both the lateral and longitudinal loads as they are separately considered.
- (5) If the total expected loads are less than the maximums permitted in Table 9.3.5.8.8(a), Table 9.3.5.8.8(b), and Table 9.3.5.8.8(c) for the particular brace and orientation, and the maximum loads in the zone of influence of each lateral sway brace are less than the maximum values in Table 9.3.5.3.2(a) or Table 9.3.5.3.2(b), go on to step (5). If not, add additional braces to reduce the zones of influence of overloaded braces.
- (6) Check that fasteners connecting the braces to structural supporting members are

adequate to support the expected loads on the braces in accordance with Table 9.3.5.8.8(a), Table 9.3.5.8.8(b), and Table 9.3.5.8.8(c). If not, again add additional braces or additional means of support. Plates using multiple fasteners in seismic assemblies should follow the plate manufacturer guidelines regarding the applied loads.

Use the information on weights of water-filled piping contained within Table A.9.3.5.6. The factor of 1.15 is intended to approximate the additional weight of all the valves, fittings, and other devices attached to the system.

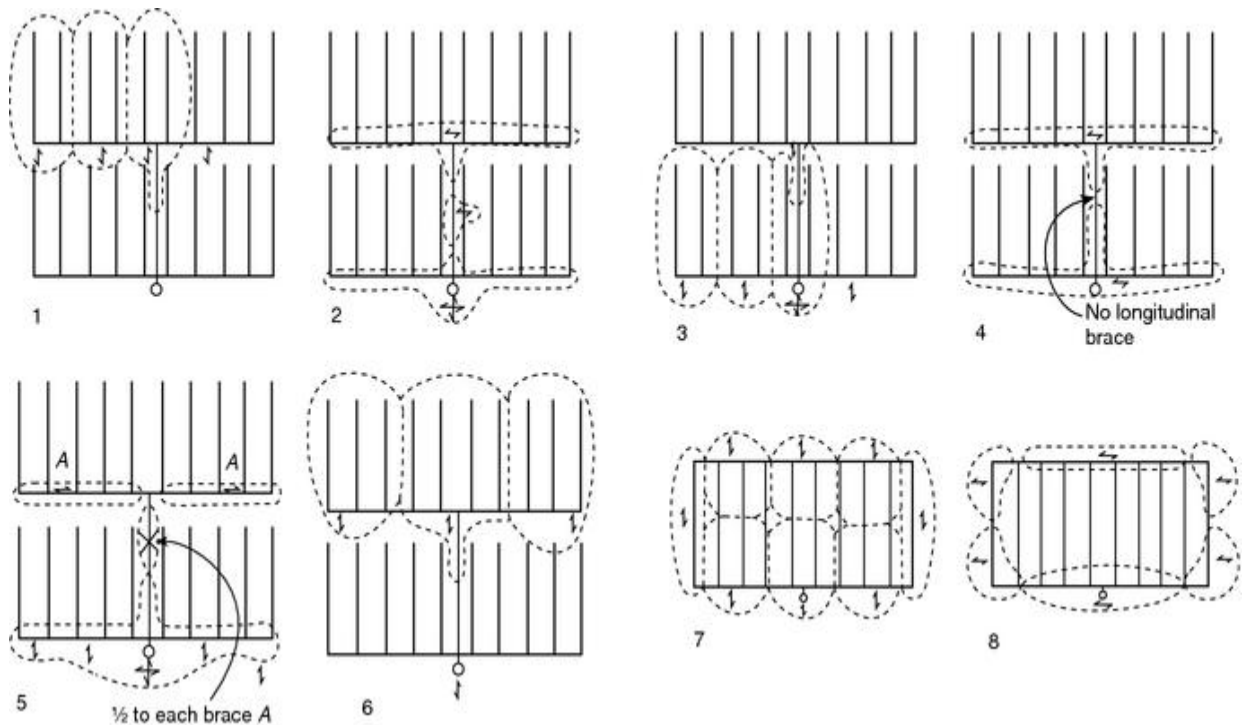

FIGURE A.9.3.5.6(e) Examples of Load Distribution to Bracing.

Table A.9.3.5.6 Piping Weights for Determining Horizontal Load

Nominal Dimensions		Weight of Water-Filled Pipe	
in.	mm	lb/ft	kg/m
Schedule 40 Pipe			
1	25	2.05	3.05
1¼	32	2.93	4.36
1½	40	3.61	5.37
2	50	5.13	7.63
2½	65	7.89	11.74
3	80	10.82	16.10
3½	90	13.48	20.06
4	100	16.40	24.41
5	125	23.47	34.93
6	150	31.69	47.16

Table A.9.3.5.6 Piping Weights for Determining Horizontal Load

Nominal Dimensions		Weight of Water-Filled Pipe	
8*	200	47.70	70.99
Schedule 10 Pipe			
1	25	1.81	2.69
1¼	32	2.52	3.75
1½	40	3.04	4.52
2	50	4.22	6.28
2½	65	5.89	8.77
3	80	7.94	11.82
3½	90	9.78	14.55
4	100	11.78	17.53
5	125	17.30	25.75
6	150	23.03	34.27
8	200	40.08	59.65

* Schedule 30.

A.9.3.5.6.1 The factors used in the computation of the horizontal seismic load should be available from several sources, including the project architect or structural engineer or the authority having jurisdiction. In addition, the ground motion parameter S_g , is available using maps or software developed by the U.S. Geological Survey. The approach presented in NFPA 13 is compatible with the requirements of SEI/ASCE 7, *Minimum Design Loads for Buildings and Other Structures*, which provides the seismic requirements for model building codes. Sprinkler systems are emergency systems and as such should be designed for an importance factor (I_p) of 1.5. Seismic load equations allow the reduction of the seismic force by a component response modification factor (R_p) that reflects the ductility of the system; systems where braced piping is primarily joined by threaded fittings should be considered less ductile than systems where braced piping is joined by welded or mechanical type fittings. In addition, a factor, a_p , is used to account for dynamic amplification of nonstructural systems supported by structures. Currently, steel piping systems typically used for fire sprinklers are assigned an R_p factor of 4.5 and an a_p factor of 2.5.

A.9.3.5.6.3 S_g is a measure of earthquake shaking intensity. S_g shall be taken as the Maximum Considered Earthquake Ground Motion for 0.2 sec Spectral Response Acceleration (5 percent of critical damping), Site Class B. The data are available from the authority having jurisdiction or, in the United States, from maps developed by the U.S. Geological Survey. All that is required to get S_g is the latitude and longitude of the project site.

The horizontal force factor was given as F_p in earlier editions of NFPA 13. It has been changed to F_{pw} , to clearly indicate that it is a working, not an ultimate, load. In model building codes, F_p is used to denote the strength design level load.

A.9.3.5.6.4 The zones of influence do not have to be symmetrically based on brace spacing. It is the intent of NFPA 13 that the chosen zone of influence be the worst-case load scenario.

A.9.3.5.8 Sway brace members should be continuous. Where necessary, splices in sway bracing members should be designed and constructed to ensure that brace integrity is maintained.

A.9.3.5.8.8 These certified allowable horizontal loads must include a minimum safety factor of 1.5 against the ultimate break strength of the brace components and then be further reduced according to the brace angles.

A.9.3.5.8.9 Maximum allowable horizontal loads for steel sway braces shown in Table 9.3.5.8.8(a), Table 9.3.5.8.8(b), and Table 9.3.5.8.8(c) are applicable when the system is designed using allowable stress design methods. The maximum allowable loads have been derived for the controlling condition (braces in compression) using American Institute of Steel Construction *Manual of Steel Construction, Allowable Stress Design* (9th Edition), Equations E2-1 and E2-2, and taking a $\frac{1}{3}$ increase in design stresses as allowed for seismic loads per Section A.5.2 of that document.

In determining allowable horizontal loads in the tables, a modulus of elasticity (E) of 29,000 ksi, a yield stress (F_y) of 36 ksi, and an effective length factor (K) of 1.0 were assumed, since these are common. If these values are different in a specific situation, table values might need to be adjusted. Gross section properties are used for all shapes except for all-thread rods. For all-thread rods, area and radius of gyration are based on the minimum area of the threaded rod based on the radius at the root of the threads.

A.9.3.5.9 Current fasteners for anchoring to concrete are referred to as post-installed anchors. There are several types of post-installed anchors, including expansion anchors, chemical or adhesive anchors, and undercut anchors. The criteria in Table 9.3.5.8.8(a), Table 9.3.5.8.8(b), and Table 9.3.5.8.8(c) are based on the use of wedge expansion anchors and undercut anchors. Use of other anchors in concrete should be in accordance with the listing provisions of the anchor. Anchorage designs are usable under ASD methods. Values in Table 9.3.5.8.8(a), Table 9.3.5.8.8(b), and Table 9.3.5.8.8(c) are based on an 8 to 1 safety factor in tension and a 4 to 1 in shear for allowable loads. Wedge anchors are torque-controlled expansion anchors that are set by applying a torque to the anchor's nut, which causes the anchor to rise while the wedge stays in place. This causes the wedge to be pulled onto a coned section of the anchor and presses the wedge against the wall of the hole. Undercut anchors might or might not be torque-controlled. Typically, the main hole is drilled, a special second drill bit is inserted into the hole, and flare is drilled at the base of the main hole. Some anchors are self-drilling and do not require a second drill bit. The anchor is then inserted into the hole and, when torque is applied the bottom of the anchor, flares out into the flared hole, and a mechanical lock is obtained. Consideration should be given with respect to the position near the edge of a slab and the spacing of anchors. Typically for full capacity in Table 9.3.5.8.8(a), Table 9.3.5.8.8(b), and Table 9.3.5.8.8(c), the edge distance should be $1\frac{1}{2}$ times the embedment and 3 times the embedment for spacing between anchors.

A.9.3.5.9.3 Through-bolt as described in 9.3.5.9.3 is intended to describe a method of bolting and attachment. It is the intent of the committee that a "through-bolt" could consist

of threaded rod with a flat washer and nut on each end.

A.9.3.5.9.7 Some of the items to be considered include the following:

- (1) The load-carrying capacities are calculated and based on combined loading.
- (2) The concrete anchors should have published shear and tension values for seismic applications.
- (3) The calculations should include the effects of prying due to the geometry of the structural attachment fitting.
- (4) The impact of the ratio of length to embedment depth of the concrete anchor should be evaluated for its impact on loading.

See A.9.3.5.9 for additional information.

A.9.3.6.1 Wires used for piping restraints should be attached to the branch line with two tight turns around the pipe and fastened with four tight turns within 1½ in. (38 mm), and should be attached to the structure in accordance with the details shown in Figure A.9.3.6.1(a) through Figure A.9.3.6.1(d) or other approved method.

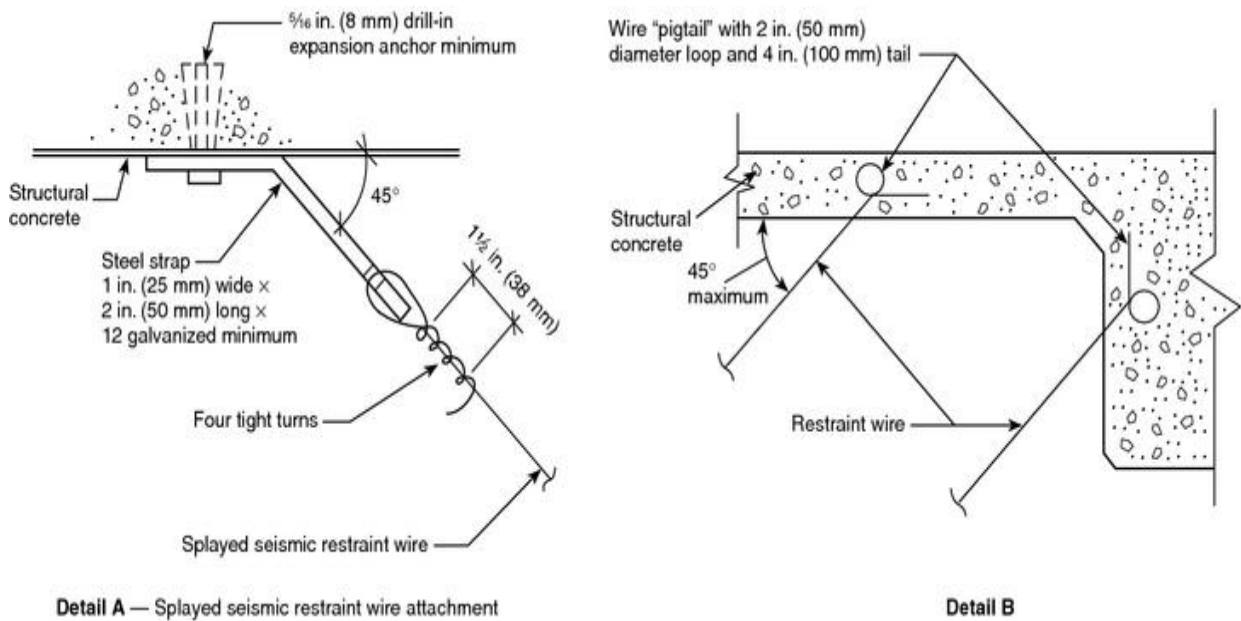
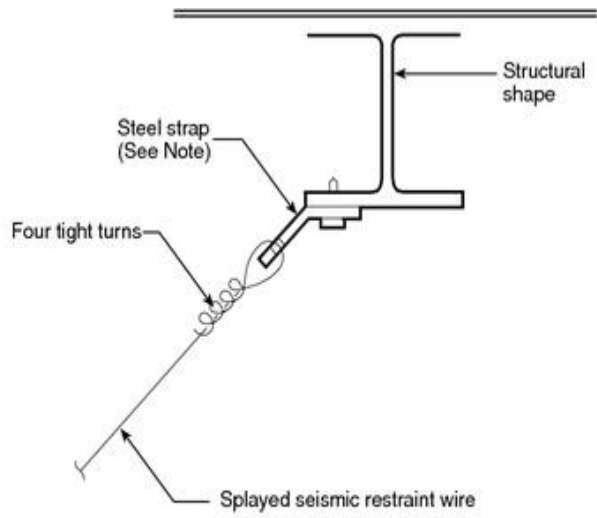
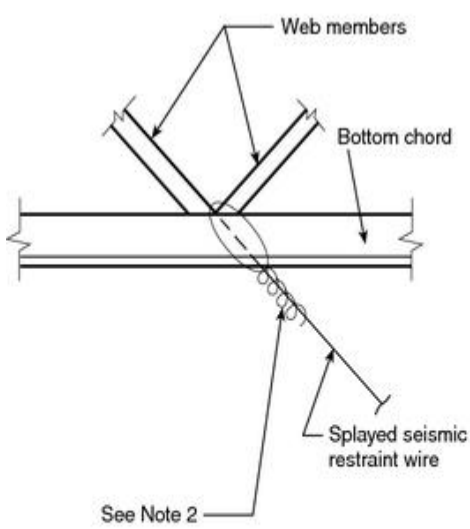

FIGURE A.9.3.6.1(a) Wire Attachment to Cast-in-Place Concrete.



Note: See Figure A.9.3.6.1(a), Detail B.
Detail A — At steel beams



Notes:
 1. Splay wires parallel to joist. Splay wires cannot be perpendicular to joist.
 2. See Figure A.9.3.6.1(a), Detail A.
Detail B — At open web steel joist

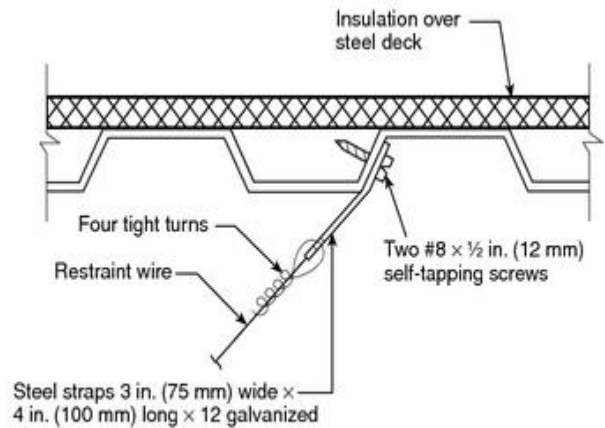

Note: If self-tapping screws are used with concrete fill, set screws before placing concrete.
Detail C — At steel roof deck

FIGURE A.9.3.6.1(b) Acceptable Details — Wire Connections to Steel Framing.

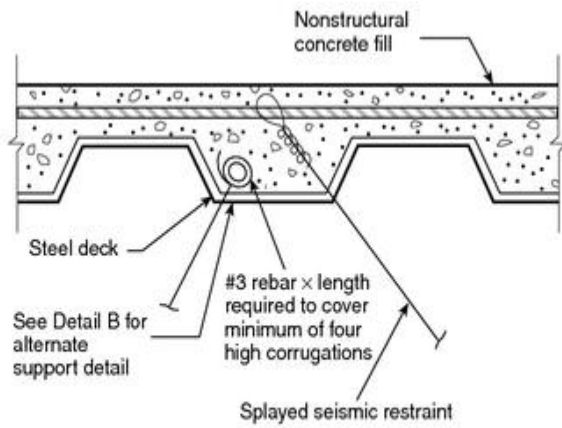

Detail A — At steel deck with insulating fill

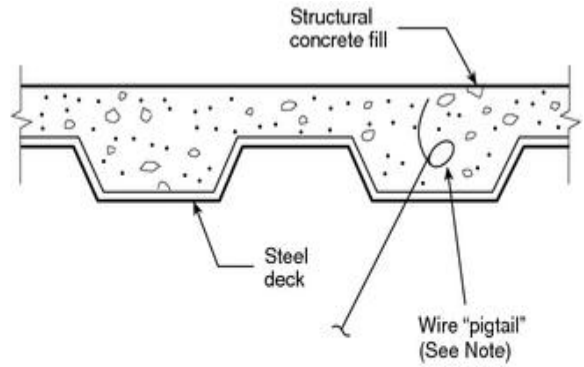

Note: See Figure A.9.3.6.1(a), Detail B.
Detail B — At steel deck with concrete fill

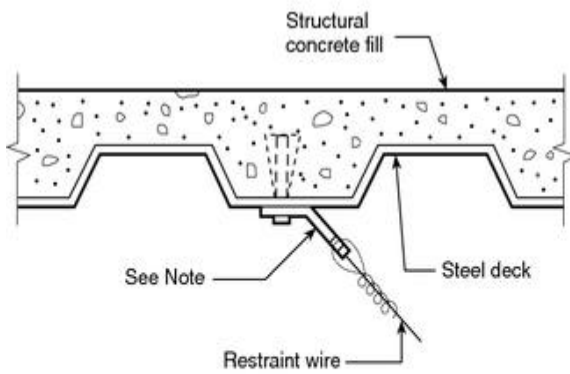

Note: See Figure A.9.3.6.1(a), Detail A.
Detail C — At steel deck with concrete fill

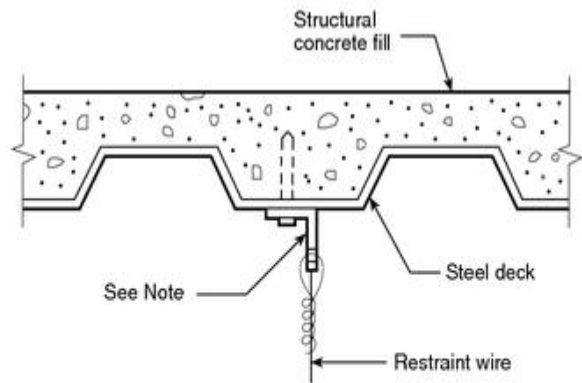

Note: See Figure A.9.3.6.1(a), Detail A.
Detail D — At steel deck with concrete fill

For SI units, 1 in. = 25.4 mm.

Note: If self-tapping screws are used with concrete fill, set screws before placing concrete.

FIGURE A.9.3.6.1(c) Acceptable Details — Wire Connections to Steel Decking with Fill.

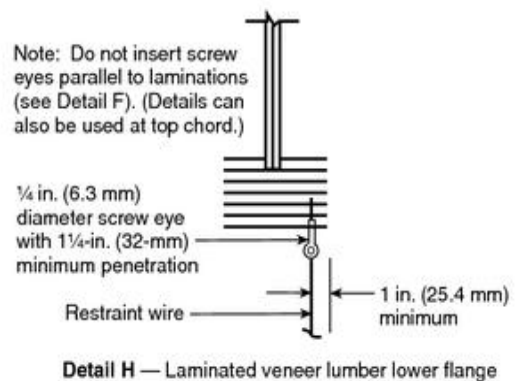
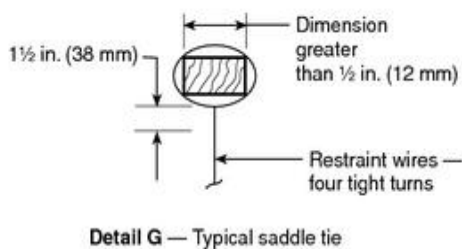
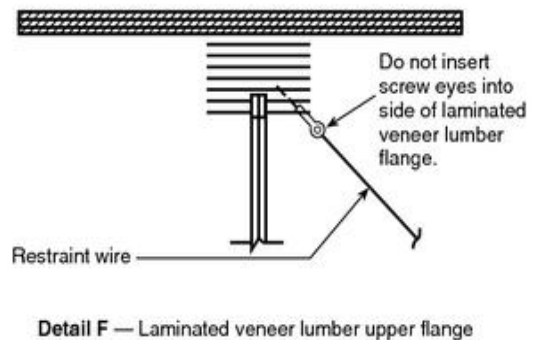
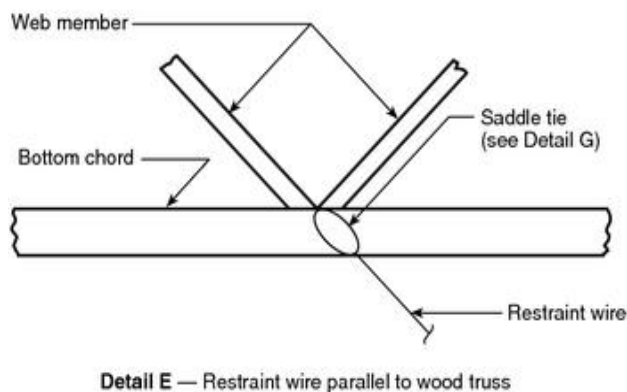
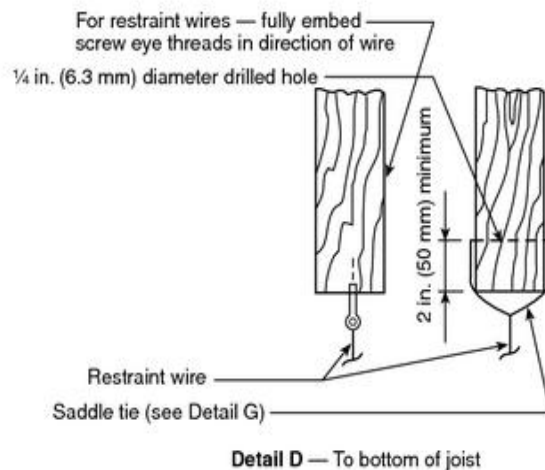
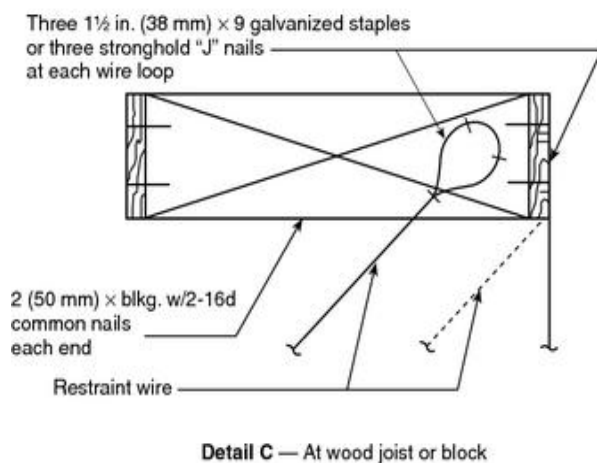
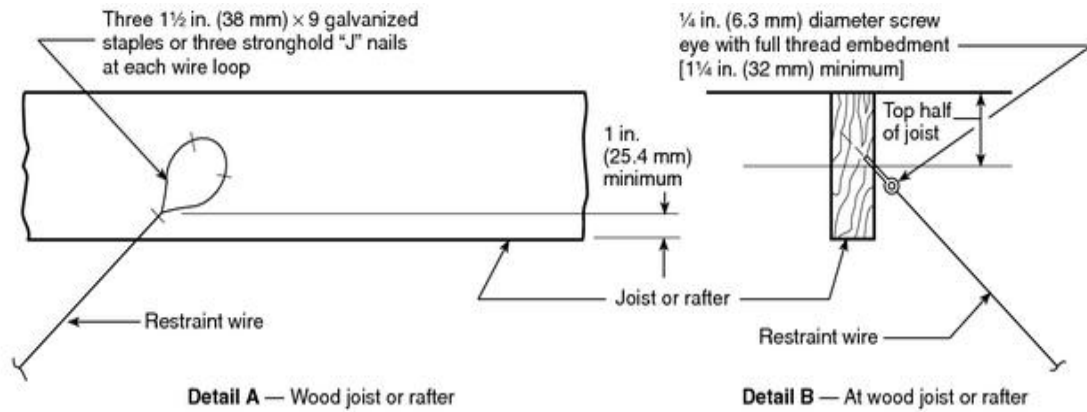

FIGURE A.9.3.6.1(d) Acceptable Details — Wire Connections to Wood Framing.

A.9.3.6.1(5) See Figure A.9.3.6.1(5)(a) and Figure A.9.3.6.1(5)(b).

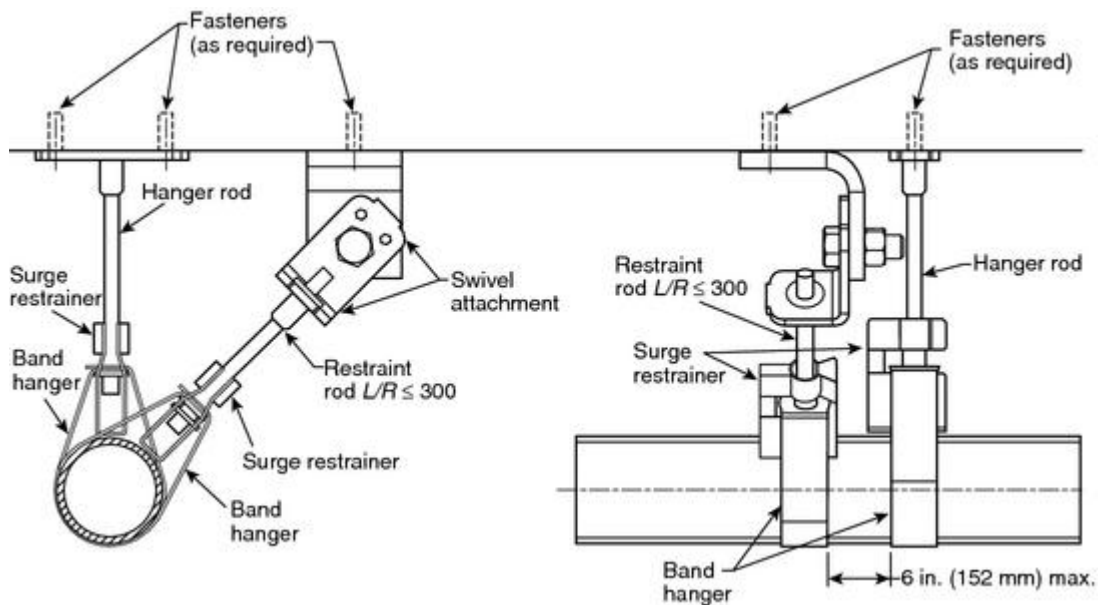

FIGURE A.9.3.6.1(5)(a) Hangers, with Surge Clips, Used in Combination for Restraint of Branch Lines.

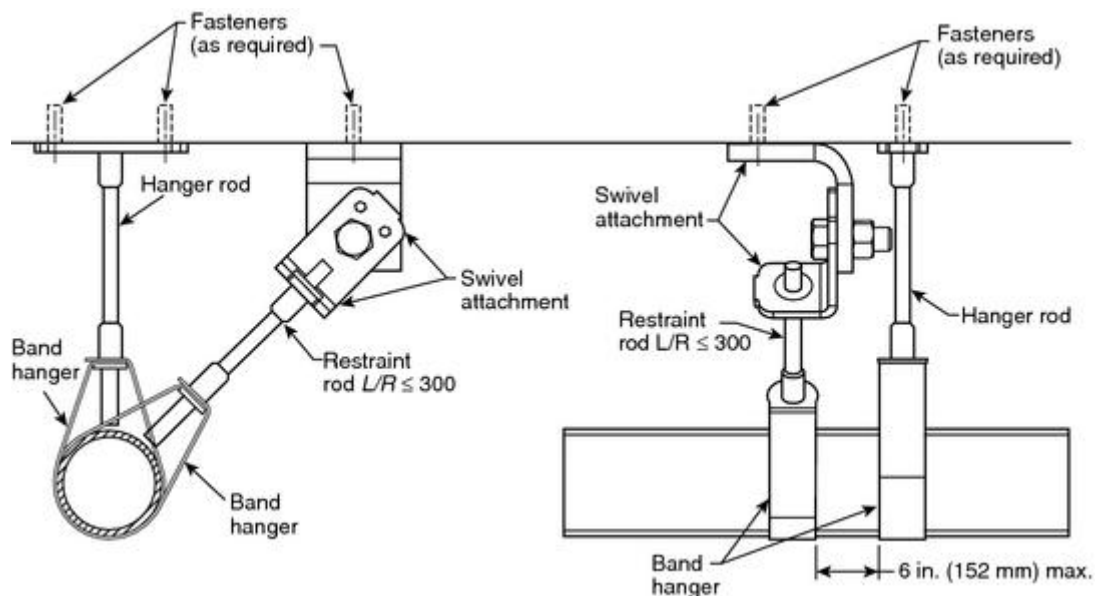

FIGURE A.9.3.6.1(5)(b) Hangers, with Threaded Rod Extended to Pipe, Used in Combination for Restraint of Branch Lines.

A.9.3.6.4 Modern seismic codes require branch lines to be restrained, both to limit interaction of the pipe with other portions of the structure and to limit stresses in the pipes to permissible limits. The maximum spacing between restraints is dependent on the seismic coefficient, C_p , as shown in Table 9.3.6.4. Table 9.3.6.4 has been limited to 2 in. (50 mm)

lines and smaller, because branch lines 2½ in. (65 mm) or larger are required to be seismically braced.

A.9.3.6.6 Such restraint can be provided by using the restraining wire discussed in 9.3.6.1.

A.10.1 The term *underground* is intended to mean direct buried piping. For example, piping installed in trenches and tunnels but exposed should be treated as aboveground piping.

Loop systems for yard piping are recommended for increased reliability and improved hydraulics. Loop systems should be sectionalized by placing valves at branches and at strategic locations to minimize the extent of impairments. [24: A.10.1]

A.10.1.1 Copper tubing (Type K) with brazed joints conforming to Table 10.1.1 and Table 10.2.1(a) is acceptable for underground service. Listing and labeling information, along with applicable publications for reference, is as follows:

- (1) *Listing and Labeling.* Testing laboratories list or label the following:
 - (a) Cast-iron and ductile iron pipe (cement-lined and unlined, coated and uncoated)
 - (b) Asbestos-cement pipe and couplings
 - (c) Steel pipe
 - (d) Copper pipe
 - (e) Fiberglass filament-wound epoxy pipe and couplings
 - (f) Polyethylene pipe
 - (g) Polyvinyl chloride (PVC) pipe and couplings
 - (h) Underwriters Laboratories Inc. lists, under re-examination service, reinforced concrete pipe (cylinder pipe, nonprestressed and prestressed)
- (2) *Pipe Standards.* The various types of pipe are usually manufactured to one of the following standards:
 - (a) ASTM C 296, *Standard Specification for Asbestos-Cement Pressure Pipe*
 - (b) AWWA C151, *Ductile Iron Pipe, Centrifugally Cast for Water*
 - (c) AWWA C300, *Reinforced Concrete Pressure Pipe, Steel-Cylinder Type, for Water and Other Liquids*
 - (d) AWWA C301, *Prestressed Concrete Pressure Pipe, Steel-Cylinder Type, for Water and Other Liquids*
 - (e) AWWA C302, *Reinforced Concrete Pressure Pipe, Non-Cylinder Type, for Water and Other Liquids*
 - (f) AWWA C303, *Reinforced Concrete Pressure Pipe, Steel-Cylinder Type, Pretensioned, for Water and Other Liquids*
 - (g) AWWA C400, *Standard for Asbestos-Cement Distribution Pipe, 4 in. Through 16 in., for Water and Other Liquids*

- (h) AWWA C900, *Polyvinyl Chloride (PVC) Pressure Pipe, 4 in. Through 12 in., for Water and Other Liquids*
 [24: A.10.1.1]

A.10.1.4 The following pipe design manuals can be used as guides:

- (1) AWWA C150, *Thickness Design of Ductile Iron Pipe*
- (2) AWWA C401, *Standard Practice for the Selection of Asbestos-Cement Water Pipe*
- (3) AWWA M41, *Ductile Iron Pipe and Fittings*
- (4) *Concrete Pipe Handbook*, American Concrete Pipe Association
 [24: A.10.1.4]

A.10.1.6 The following standards apply to the application of coating and linings:

- (1) AWWA C104, *Cement Mortar Lining For Ductile Iron Pipe and Fittings for Water*
- (2) AWWA C105, *Polyethylene Encasement for Ductile Iron Pipe Systems*
- (3) AWWA C203, *Coal-Tar Protective Coatings and Linings for Steel Water Pipelines Enamel and Tape — Hot Applied*
- (4) AWWA C205, *Cement-Mortar Protective Lining and Coating for Steel Water Pipe 4 in. and Larger — Shop Applied*
- (5) AWWA C602, *Cement-Mortar Lining of Water Pipe Lines 4 in. and Larger — in Place*
- (6) AWWA C116, *Protective Fusion-Bonded Epoxy Coatings for the Interior and Exterior Surfaces of Ductile-Iron and Gray Iron Fittings for Water Supply Service*

For internal diameters of cement-lined ductile iron pipe, see Table A.10.1.6.

[24: A.10.1.6]

Table A.10.1.6 ID for Cement-Lined Ductile Iron Pipe						
Pipe Size (in.)	OD (in.)	Pressure Class	Thickness Class	Wall Thickness	Minimum Lining Thickness*	ID with l
3	3.96	350		0.25	$\frac{1}{16}$	3.
3	3.96		51	0.25	$\frac{1}{16}$	3.
3	3.96		52	0.28	$\frac{1}{16}$	3.
3	3.96		53	0.31	$\frac{1}{16}$	3.
3	3.96		54	0.34	$\frac{1}{16}$	3.
3	3.96		55	0.37	$\frac{1}{16}$	3.
3	3.96		56	0.40	$\frac{1}{16}$	3.
4	4.80	350		0.25	$\frac{1}{16}$	4.

Table A.10.1.6 ID for Cement-Lined Ductile Iron Pipe

Pipe Size (in.)	OD (in.)	Pressure Class	Thickness Class	Wall Thickness	Minimum Lining Thickness*	ID with L
4	4.80		51	0.26	1/16	4.
4	4.80		52	0.29	1/16	4.
4	4.80		53	0.32	1/16	4.
4	4.80		54	0.35	1/16	3.
4	4.80		55	0.38	1/16	3.
4	4.80		56	0.41	1/16	3.
6	6.90	350		0.25	1/16	6.
6	6.90		50	0.25	1/16	6.
6	6.90		51	0.28	1/16	6.
6	6.90		52	0.31	1/16	6.
6	6.90		53	0.34	1/16	6.
6	6.90		54	0.37	1/16	6.
6	6.90		55	0.40	1/16	5.
6	6.90		56	0.43	1/16	5.
8	9.05	350		0.25	1/16	8.
8	9.05		50	0.27	1/16	8.
8	9.05		51	0.30	1/16	8.
8	9.05		52	0.33	1/16	8.
8	9.05		53	0.36	1/16	8.
8	9.05		54	0.39	1/16	8.
8	9.05		55	0.42	1/16	8.
8	9.05		56	0.45	1/16	8.
10	11.10	350		0.26	1/16	10
10	11.10		50	0.29	1/16	10
10	11.10		51	0.32	1/16	10
10	11.10		52	0.35	1/16	10
10	11.10		53	0.38	1/16	10
10	11.10		54	0.41	1/16	10
10	11.10		55	0.44	1/16	10
10	11.10		56	0.47	1/16	10
12	13.20	350		0.28	1/16	12

Table A.10.1.6 ID for Cement-Lined Ductile Iron Pipe

Pipe Size (in.)	OD (in.)	Pressure Class	Thickness Class	Wall Thickness	Minimum Lining Thickness*	ID with L
12	13.20		50	0.31	1/16	12
12	13.20		51	0.34	1/16	12
12	13.20		52	0.37	1/16	12
12	13.20		53	0.40	1/16	12
12	13.20		54	0.43	1/16	12
12	13.20		55	0.46	1/16	12
12	13.20		56	0.49	1/16	12
14	15.30	250		0.28	3/32	14
14	15.30	300		0.30	3/32	14
14	15.30	350		0.31	3/32	14
14	15.30		50	0.33	3/32	14
14	15.30		51	0.36	3/32	14
14	15.30		52	0.39	3/32	14
14	15.30		53	0.42	3/32	14
14	15.30		54	0.45	3/32	14
14	15.30		55	0.48	3/32	14
14	15.30		56	0.51	3/32	14
16	17.40	250		0.30	3/32	16
16	17.40	300		0.32	3/32	16
16	17.40	350		0.34	3/32	16
16	17.40		50	0.34	3/32	16
16	17.40		51	0.37	3/32	16
16	17.40		52	0.40	3/32	16
16	17.40		53	0.43	3/32	16
16	17.40		54	0.46	3/32	16
16	17.40		55	0.49	3/32	16
16	17.40		56	0.52	3/32	16
18	19.50	250		0.31	3/32	18
18	19.50	300		0.34	3/32	18
18	19.50	350		0.36	3/32	18
18	19.50		50	0.35	3/32	18

Table A.10.1.6 ID for Cement-Lined Ductile Iron Pipe

Pipe Size (in.)	OD (in.)	Pressure Class	Thickness Class	Wall Thickness	Minimum Lining Thickness*	ID with L
18	19.50		51	0.35	3/32	18
18	19.50		52	0.41	3/32	18
18	19.50		53	0.44	3/32	18
18	19.50		54	0.47	3/32	18
18	19.50		55	0.50	3/32	18
18	19.50		56	0.53	3/32	18
20	21.60	250		0.33	3/32	20
20	21.60	300		0.36	3/32	20
20	21.60	350		0.38	3/32	20
20	21.60		50	0.36	3/32	20
20	21.60		51	0.39	3/32	20
20	21.60		52	0.42	3/32	20
20	21.60		53	0.45	3/32	20
20	21.60		54	0.48	3/32	20
20	21.60		55	0.51	3/32	20
20	21.60		56	0.54	3/32	20
24	25.80	200		0.33	3/32	24
24	25.80	250		0.37	3/32	24
24	25.80	300		0.40	3/32	24
24	25.80	350		0.43	3/32	24
24	25.80		50	0.38	3/32	24
24	25.80		51	0.41	3/32	24
24	25.80		52	0.44	3/32	24
24	25.80		53	0.47	3/32	24
24	25.80		54	0.50	3/32	24
24	25.80		55	0.53	3/32	24
24	25.80		56	0.56	3/32	24

*Note: This table is appropriate for single lining thickness only. The actual lining thickness should be obtained from the manufacturer. [24: Table A.10.1.6]

A.10.2.4 The following standards apply to joints used with the various types of pipe:

Copyright NFPA

- (1) ASME B16.1, *Cast-Iron Pipe Flanges and Flanged Fittings*
- (2) AWWA C111, *Rubber-Gasket Joints for Ductile Iron Pressure Pipe and Fittings*
- (3) AWWA C115, *Flanged Ductile Iron Pipe with Ductile Iron or Gray Iron Threaded Flanges*
- (4) AWWA C206, *Field Welding of Steel Water Pipe*
- (5) AWWA C606, *Grooved and Shouldered Joints*[24: A.10.2.4]

A.10.2.5 Fittings generally used are cast iron with joints made to the specifications of the manufacturer of the particular type of pipe (*see the standards listed in A.10.2.4*). Steel fittings also have some applications. The following standards apply to fittings:

- (1) ASME B16.1, *Cast-Iron Pipe Flanges and Flanged Fittings*
- (2) AWWA C110, *Ductile Iron and Gray Iron Fittings, 3-in. Through 48-in., for Water and Other Liquids*
- (3) AWWA C153, *Ductile Iron Compact Fittings, 3 in. through 24 in. and 54 in. through 64 in. for Water Service*
- (4) AWWA C208, *Dimensions for Fabricated Steel Water Pipe Fittings*[24: A.10.2.5]

A.10.4.1 The following documents apply to the installation of pipe and fittings:

- (1) AWWA C603, *Standard for the Installation of Asbestos-Cement Water Pipe*
- (2) AWWA C600, *Standard for the Installation of Ductile-Iron Water Mains and Their Appurtenances*
- (3) AWWA M11, *A Guide for Steel Pipe Design and Installation*
- (4) AWWA M41, *Ductile Iron Pipe and Fittings*
- (5) *Concrete Pipe Handbook*, American Concrete Pipe Association
- (6) *Handbook of PVC Pipe*, Uni-Bell PVC Pipe Association
- (7) *Installation Guide for Ductile Iron Pipe*, Ductile Iron Pipe Research Association
- (8) *Thrust Restraint Design for Ductile Iron Pipe*, Ductile Iron Pipe Research Association

As there is normally no circulation of water in private fire mains, they require greater depth of covering than do public mains. Greater depth is required in a loose gravelly soil (or in rock) than in compact soil containing large quantities of clay. The recommended depth of cover above the top of underground yard mains is shown in Figure A.10.4.1. [24: A.10.4.1]

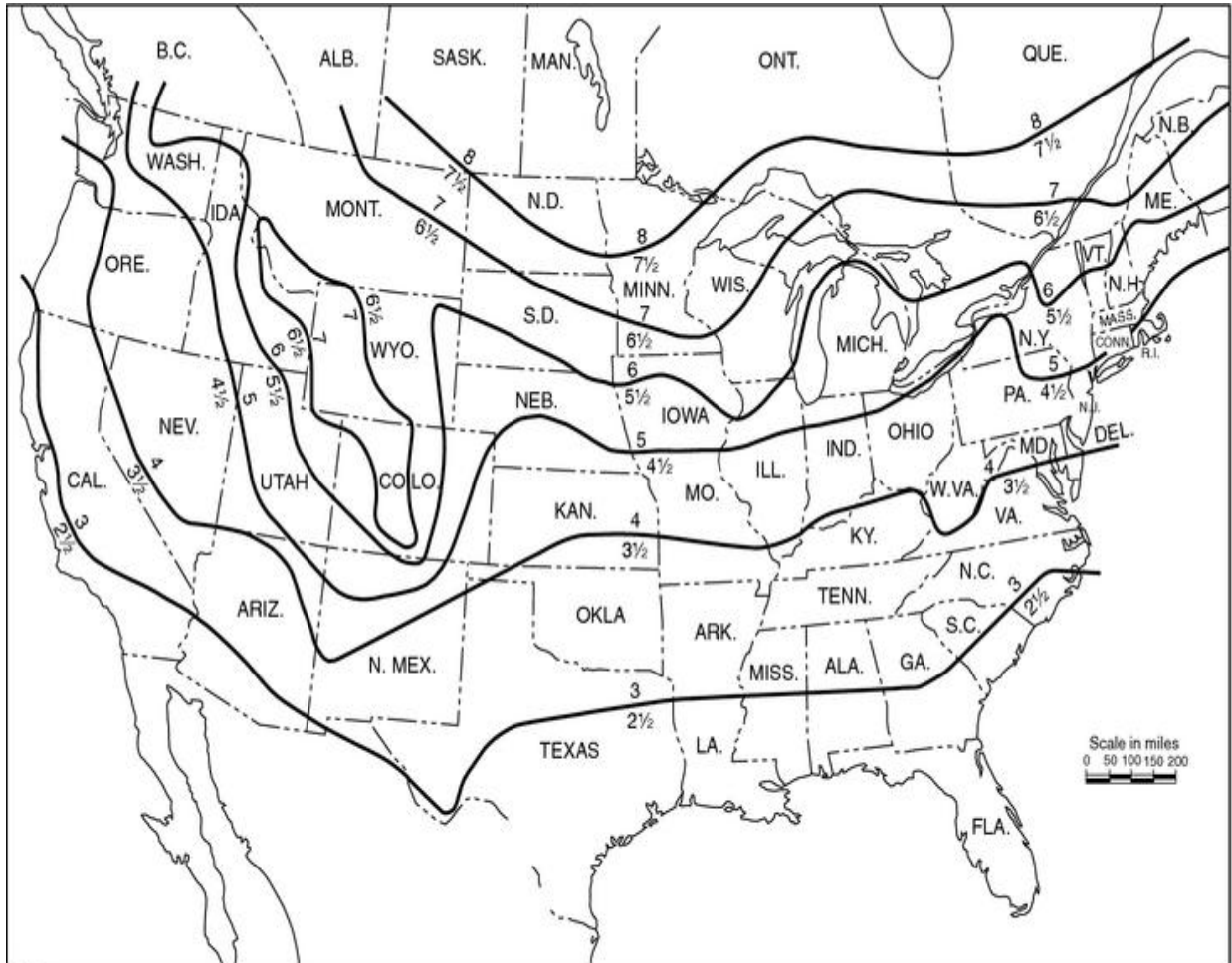

Notes:

1. For SI Units, 1 in. = 25.4 mm; 1 ft = 0.304 m.
2. Where frost penetration is a factor, the depth of cover shown averages 6 in. greater than that usually provided by the municipal waterworks. Greater depth is needed because of the absence of flow in yard mains.

FIGURE A.10.4.1 Recommended Depth of Cover (in feet) Above Top of Underground Yard Mains. [24: Figure A.10.4.1]

A.10.5.1 In determining the need to protect aboveground piping from freezing, the lowest mean temperature should be considered as shown in Figure A.10.5.1. [24: A.10.5.1]

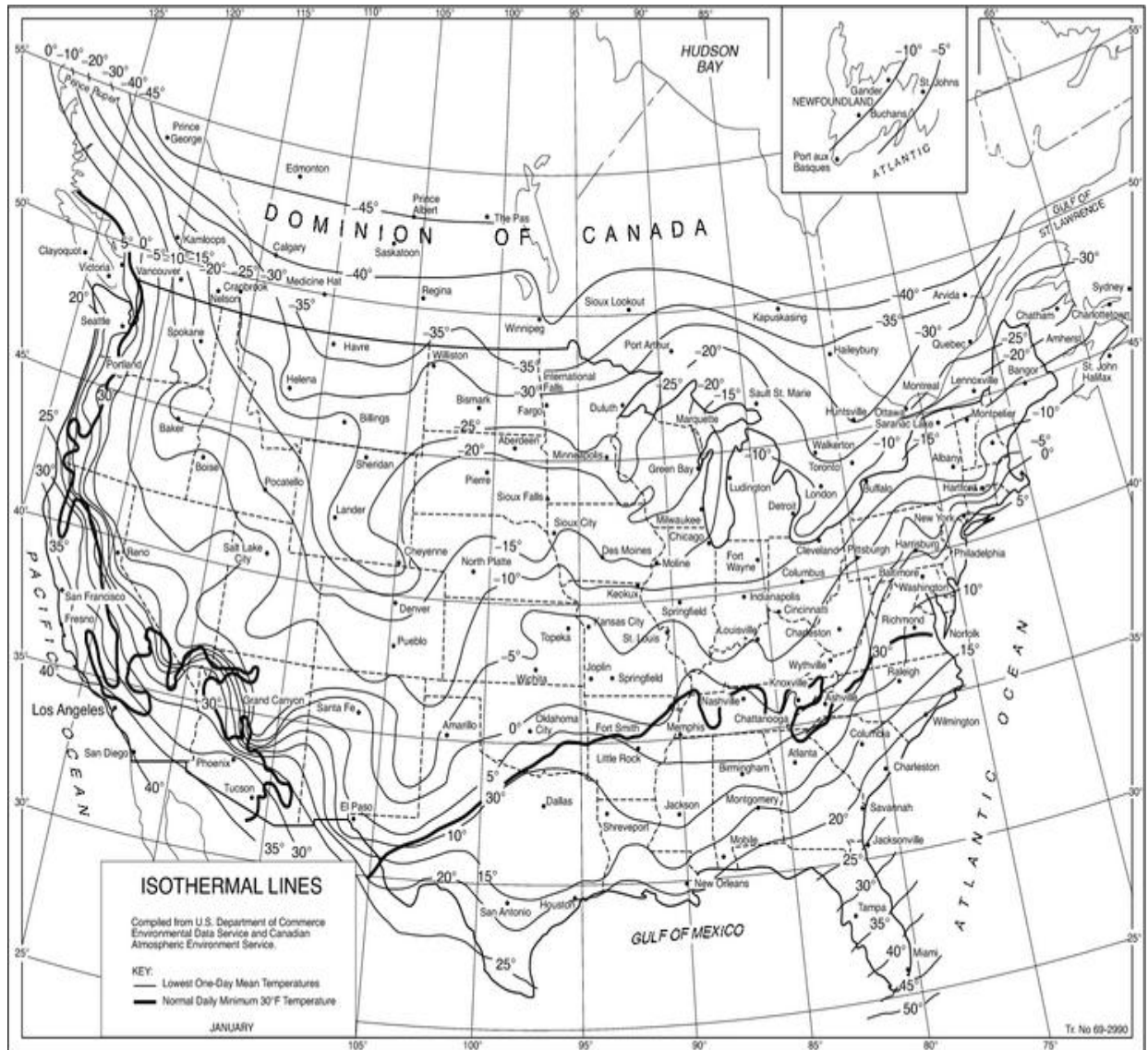

FIGURE A.10.5.1 Isothermal Lines — Lowest One-Day Mean Temperature (°F). [24: Figure A.10.5.1]

A.10.6.7 Gray cast iron is not considered galvanically dissimilar to ductile iron. Rubber gasket joints (unrestrained push-on or mechanical joints) are not considered connected electrically. Metal thickness should not be considered a protection against corrosive environments. In the case of cast-iron or ductile iron pipe for soil evaluation and external protection systems, see Appendix A of AWWA C105, *Polyethylene Encasement for Ductile Iron Pipe Systems*. [24: A.10.6.7]

A.10.6.8 Where lightning protection is provided for a structure, NFPA 780, 4.14 requires that all grounding media including underground metallic piping systems be interconnected to provide a common ground potential. These underground piping systems are not permitted to be substituted for grounding electrodes but must be bonded to the lightning protection grounding system. Where galvanic corrosion is of concern, this bond may be made via

Copyright NFPA

spark gap or gas discharge tube. [24: A.10.6.8]

A.10.8.1.1 It is a fundamental design principle of fluid mechanics that dynamic and static pressures, acting at changes in size or direction of a pipe, produce unbalanced thrust forces at locations such as bends, tees, wyes, dead ends, and reducer offsets. This design principle includes consideration of lateral soil pressure and pipe/soil friction, variables that can be reliably determined using current soil engineering knowledge. Refer to A.10.8.3 for a list of references for use in calculating and determining joint restraint systems.

Except for the case of welded joints and approved special restrained joints, such as is provided by approved mechanical joint retainer glands or locked mechanical and push-on joints, the usual joints for underground pipe are expected to be held in place by the soil in which the pipe is buried. Gasketed push-on and mechanical joints without special locking devices have limited ability to resist separation due to movement of the pipe.

[24: A.10.8.1.1]

A.10.8.2 Thrust Blocks. Concrete thrust blocks are one of the methods of restraint now in use, provided that stable soil conditions prevail and space requirements permit placement. Successful blocking is dependent upon factors such as location, availability and placement of concrete, and possibility of disturbance by future excavations.

Resistance is provided by transferring the thrust force to the soil through the larger bearing area of the block such that the resultant pressure against the soil does not exceed the horizontal bearing strength of the soil. The design of thrust blocks consists of determining the appropriate bearing area of the block for a particular set of conditions. The parameters involved in the design include pipe size, design pressure, angle of the bend (or configuration of the fitting involved), and the horizontal bearing strength of the soil.

Table A.10.8.2(a) gives the nominal thrust at fittings for various sizes of ductile iron and PVC piping. Figure A.10.8.2(a) shows an example of how thrust forces act on a piping bend.

Table A.10.8.2(a) Thrust at Fittings at 100 psi (6.9 bar) Water Pressure for Ductile Iron

Nominal Pipe Diameter (in.)	Total Pounds				
	Dead End	90 Degree Bend	45 Degree Bend	22½ Degree Bend	11¼ Degree Bend
4	1,810	2,559	1,385	706	355
6	3,739	5,288	2,862	1,459	733
8	6,433	9,097	4,923	2,510	1,261
10	9,677	13,685	7,406	3,776	1,897
12	13,685	19,353	10,474	5,340	2,683
14	18,385	26,001	14,072	7,174	3,604
16	23,779	33,628	18,199	9,278	4,661
18	29,865	42,235	22,858	11,653	5,855
20	36,644	51,822	28,046	14,298	7,183
24	52,279	73,934	40,013	20,398	10,249
30	80,425	113,738	61,554	31,380	15,766
36	115,209	162,931	88,177	44,952	22,585
42	155,528	219,950	119,036	60,684	30,489

Copyright NFPA

Table A.10.8.2(a) Thrust at Fittings at 100 psi (6.9 bar) Water Pressure for Ductile Iron

Nominal Pipe Diameter (in.)	Total Pounds				
	Dead End	90 Degree Bend	45 Degree Bend	22½ Degree Bend	11¼ Degree Bend
48	202,683	286,637	155,127	79,083	39,733

Notes:

(1) For SI units, 1 lb = 0.454 kg.

(2) To determine thrust at pressure other than 100 psi (6.9 bar), multiply the thrust obtained in the table by the pressure to 100 psi (6.9 bar). For example, the thrust on a 12 in., 90 degree bend at 125 psi (8.6 bar) is 19,353 24,191 lb.

[24: Table A.10.8.2(a)]

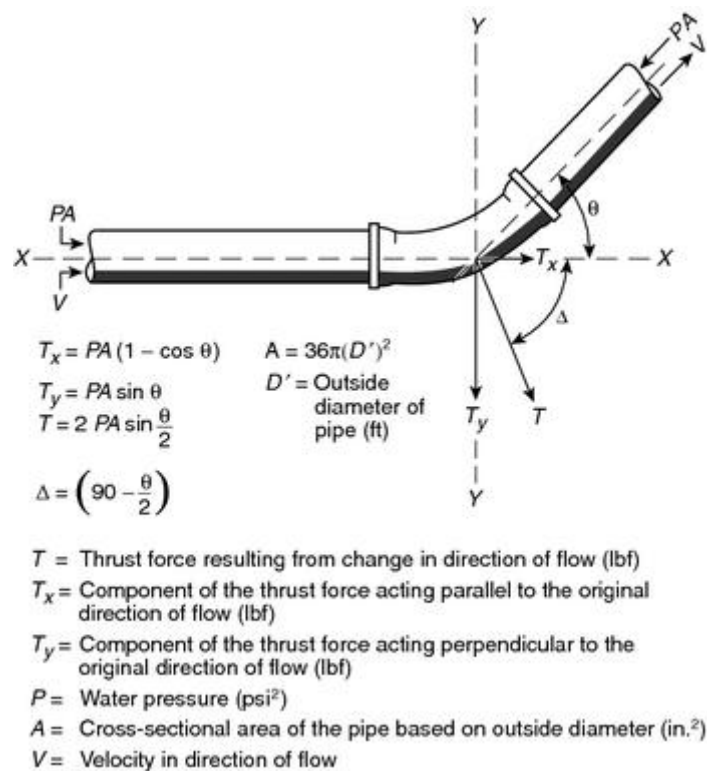

FIGURE A.10.8.2(a) Thrust Forces Acting on a Bend. [24:Figure A.10.8.2(a)]

Thrust blocks are generally categorized into two groups — bearing and gravity blocks. Figure A.10.8.2(b) depicts a typical bearing thrust block on a horizontal bend.

The following are general criteria for bearing block design:

- (1) The bearing surface should, where possible, be placed against undisturbed soil.
- (2) Where it is not possible to place the bearing surface against undisturbed soil, the fill between the bearing surface and undisturbed soil must be compacted to at least 90 percent Standard Proctor density.
- (3) Block height (h) should be equal to or less than one-half the total depth to the bottom

of the block (H_v) but not less than the pipe diameter (D).

- (4) Block height (h) should be chosen such that the calculated block width (b) varies between one and two times the height.
- (5) Gravity thrust blocks can be used to resist thrust at vertical down bends. In a gravity thrust block, the weight of the block is the force providing equilibrium with the thrust force. The design problem is then to calculate the required volume of the thrust block of a known density. The vertical component of the thrust force in Figure A.10.8.2(c) is balanced by the weight of the block. For required horizontal bearing block areas, see Table A.10.8.2(a).

The required block area (A_b) is as follows:

$$A_b = (h)(b) = \frac{T(S_f)}{S_b}$$

where:

A_b = required block area (ft²)

h = block height (ft)

b = calculated block width (ft)

T = thrust force (lbf)

S_f = safety factor (usually 1.5)

S_b = bearing strength (lb/ft²)

Then, for a horizontal bend, the following formula is used:

$$b = \frac{2(S_f)(P)(A)\sin\frac{\theta}{2}}{(h)(S_b)}$$

where:

b = calculated block width (ft)

S_f = safety factor (usually 1.5 for thrust block design)

P = water pressure (lb/in.²)

A = cross-sectional area of the pipe based on outside diameter

h = block height (ft)

S_b = horizontal bearing strength of the soil (lb/ft²) (in.²)

A similar approach can be used to design bearing blocks to resist the thrust forces at locations such as tees and dead ends. Typical values for conservative horizontal bearing strengths of various soil types are listed in Table A.10.8.2(b).

In lieu of the values for soil bearing strength shown in Table A.10.8.2(b), a designer might choose to use calculated Rankine passive pressure (F_p) or other determination of soil-bearing

A similar approach can be used to design bearing blocks to resist the thrust forces at locations such as tees and dead ends. Typical values for conservative horizontal bearing strengths of various soil types are listed in Table A.10.8.2(b).

In lieu of the values for soil bearing strength shown in Table A.10.8.2(b), a designer might choose to use calculated Rankine passive pressure (P_p) or other determination of soil-bearing strength based on actual soil properties.

Table A.10.8.2(b) Horizontal Bearing Strengths

Soil	Bearing Strength, S_b	
	lb/ft ²	kN/m ²
Muck	0	0
Soft clay	1000	47.9
Silt	1500	71.8
Sandy silt	3000	143.6
Sand	4000	191.5
Sandy clay	6000	287.3
Hard clay	9000	430.9

Note: Although the bearing strength values in this table have been used successfully in the design of thrust blocks and are considered to be conservative, their accuracy is totally dependent on accurate soil identification and evaluation. The ultimate responsibility for selecting the proper bearing strength of a particular soil type must rest with the design engineer.

[24: Table A.10.8.2(b)]

Table A.10.8.2(c) Required Horizontal Bearing Block Area

Nominal Pipe Diameter (in.)	Bearing Block Area (ft ²)	Nominal Pipe Diameter (in.)	Bearing Block Area (ft ²)	Nominal Pipe Diameter (in.)	Bearing Block Area (ft ²)
3	2.6	12	29.0	24	110.9
4	3.8	14	39.0	30	170.6
6	7.9	16	50.4	36	244.4
8	13.6	18	63.3	42	329.9
10	20.5	20	77.7	48	430.0

(1) Although the bearing strength values in this table have been used successfully in the design of thrust blocks and are considered to be conservative, their accuracy is totally dependent on the accurate soil identification and evaluation. The ultimate responsibility for selecting the proper bearing strength of a particular soil type must rest with the design engineer.

(2) Values listed are based on a 90 degree horizontal bend, an internal pressure of 100 psi, a soil horizontal bearing strength of 1,000 lb/ft², a safety factor of 1.5, and ductile-iron pipe outside diameters.

(a) For other horizontal bends, multiply by the following coefficients: 45 degree: 0.414; 22 ½ degree: 0.199; 11 ¼ degree: 0.098.

(b) For other internal pressures, multiply by ratio to 100 psi.

(c) For other soil horizontal bearing strengths, divide by ratio to 1,000 lb/ft².

(d) For other safety factors, multiply by ratio to 1.5.

Example. Using Table A.10.8.2(c), find the horizontal bearing block area for a 6 in. diameter, 45 degree bend with an internal pressure of 150 psi. The soil bearing strength is 3,000 lb/ft², and the safety factor is 1.5.

From Table A.10.8.2(c), the required bearing block area for a 6 in. diameter, 90 degree bend with an internal pressure of 100 psi and a soil horizontal bearing strength of 1,000 psi is 7.9 ft².

For our problem:

$$Area = \frac{7.9 \text{ ft}^2 (0.414) \frac{150}{100}}{\frac{3,000}{1,000}} = 1.64 \text{ ft}^2$$

[24: Table A.10.8.2(c)]

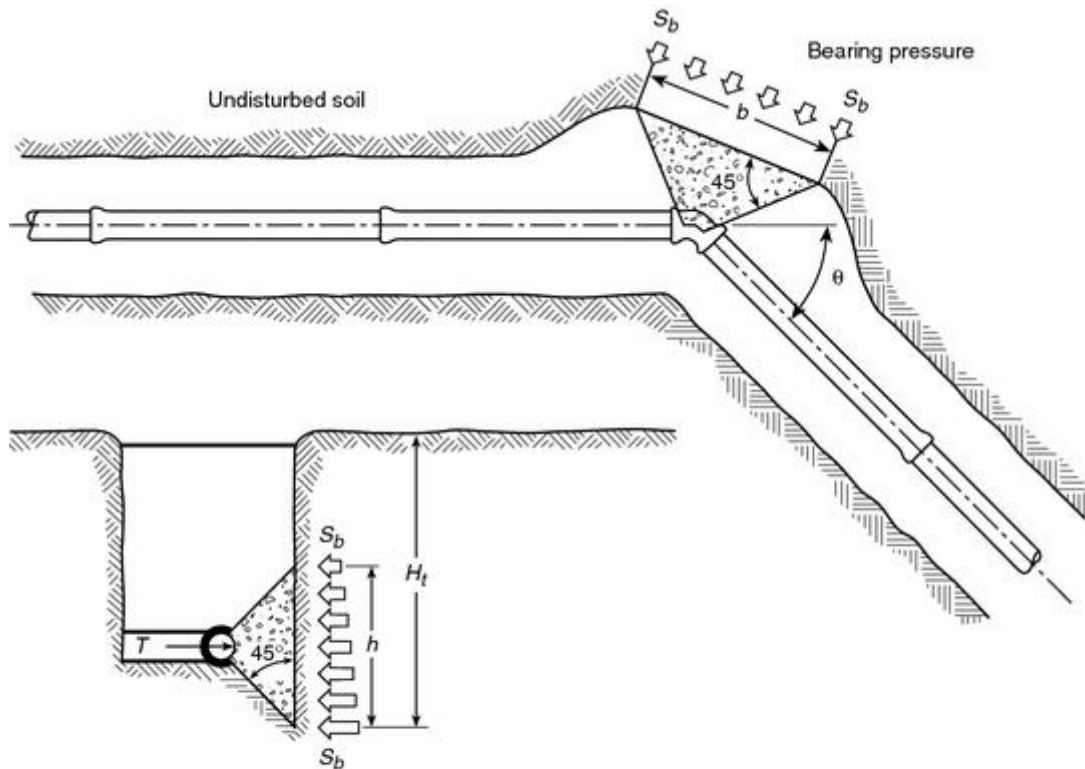

- T = thrust force resulting from the change in direction of flow
- S_b = horizontal bearing strength of the soil
- h = block height
- H_t = total depth to bottom of block

FIGURE A.10.8.2(b) Bearing Thrust Block. [24:Figure A.10.8.2(b)]

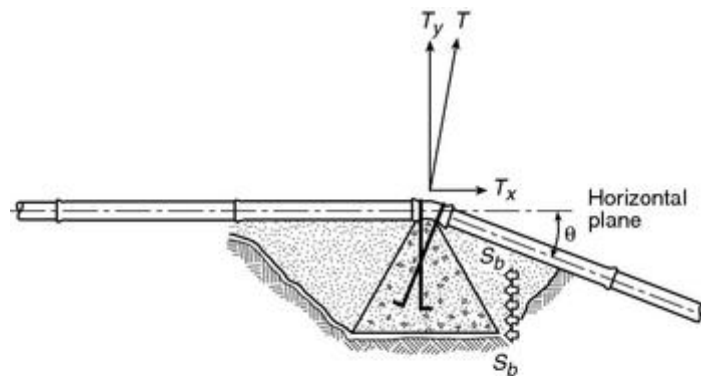

- T Thrust force resulting from the change of direction of flow
- T_x Horizontal component of the thrust force
- T_y Vertical component of the thrust force
- S_b Horizontal bearing strength of the soil

FIGURE A.10.8.2(c) Gravity Thrust Block. [24:Figure A.10.8.2(c)]

It can be easily be shown that $T_y = PA \sin \theta$. The required volume of the block is as follows:

$$V_g = \frac{S_f PA \sin \theta}{W_m}$$

where:

V_g = block volume (ft³)

S_f = safety factor

P = water pressure (psi)

A = cross-sectional area of the pipe interior

W_m = density of the block material (lb/ft³)

In a case such as the one shown, the horizontal component of thrust force is calculated as follows:

$$T_x = PA(1 - \cos \theta)$$

where:

T_x = horizontal component of the thrust force

P = water pressure

A = cross-sectional area of the pipe interior

The horizontal component of thrust force must be resisted by the bearing of the right side of the block against the soil. Analysis of this aspect follows the same principles as the previous section on bearing blocks.

[24: A.10.8.2]

A.10.8.3 Restrained Joint Systems. A method for providing thrust restraint is the use of restrained joints. A restrained joint is a special type of joint that is designed to provide longitudinal restraint. Restrained joint systems function in a manner similar to thrust blocks, insofar as the reaction of the entire restrained unit of piping with the soil balances the thrust forces.

The objective in designing a restrained joint thrust restraint system is to determine the length of pipe that must be restrained on each side of the focus of the thrust force. This will be a function of the pipe size, the internal pressure, the depth of cover, and the characteristics of the solid surrounding the pipe.

The following documents apply to the design, calculation, and determination of restrained joint systems:

- (1) *Thrust Restraint Design for Ductile Iron Pipe*, Ductile Iron Pipe Research Association
- (2) AWWA M41, *Ductile Iron Pipe and Fittings*
- (3) AWWA M9, *Concrete Pressure Pipe*
- (4) AWWA M11, *Steel Pipe — A Guide for Design and Installation*
- (5) *Thrust Restraint Design Equations and Tables for Ductile Iron and PVC Pipe*, Copyright NFPA

EBA Iron, Inc.

Figure A.10.8.3 shows an example of a typical connection to a fire protection system riser utilizing restrained joint pipe.

[24: A.10.8.3]

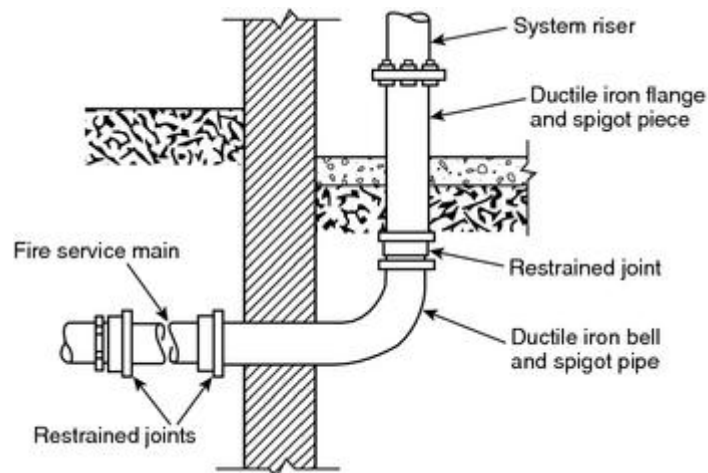

FIGURE A.10.8.3 Typical Connection to a Fire Protection System Riser Illustrating Restrained Joints. [24:Figure A.10.8.3]

A.10.8.3.5 Examples of materials and the standards covering these materials are as follows:

- (1) Clamps, steel (*see discussion on steel in the following paragraph*)
- (2) Rods, steel (*see discussion on steel in the following paragraph*)
- (3) Bolts, steel (ASTM A 307, *Standard Specification for Carbon Steel Bolts and Studs*)
- (4) Washers, steel (*see discussion on steel in the following paragraph*); cast iron (Class A cast iron as defined by ASTM A 126, *Standard Specification for Gray Iron Casting for Valves, Flanges and Pipe Fittings*)
- (5) Anchor straps and plug straps, steel (*see discussion on steel in the following paragraph*)
- (6) Rod couplings or turnbuckles, malleable iron (ASTM A 197, *Standard Specification for Cupola Malleable Iron*)

Steel of modified range merchant quality as defined in U.S. Federal Standard No. 66C, *Standard for Steel Chemical Composition and Harden Ability*, April 18, 1967, change notice No. 2, April 16, 1970, as promulgated by the U.S. Federal Government General Services Administration.

The materials specified in A.10.8.3.5(1) through (6) do not preclude the use of other materials that will also satisfy the requirements of this section.

[24: A.10.8.3.5]

A.10.10.2.1 Underground mains and lead-in connections to system risers should be flushed

Copyright NFPA

through hydrants at dead ends of the system or through accessible aboveground flushing outlets allowing the water to run until clear. Figure A.10.10.2.1 shows acceptable examples of flushing the system. If water is supplied from more than one source or from a looped system, divisional valves should be closed to produce a high-velocity flow through each single line. The flows specified in Table 10.10.2.1.3 will produce a velocity of at least 10 ft/sec (3 m/sec), which is necessary for cleaning the pipe and for lifting foreign material to an aboveground flushing outlet. [24: A.10.8.2.1]

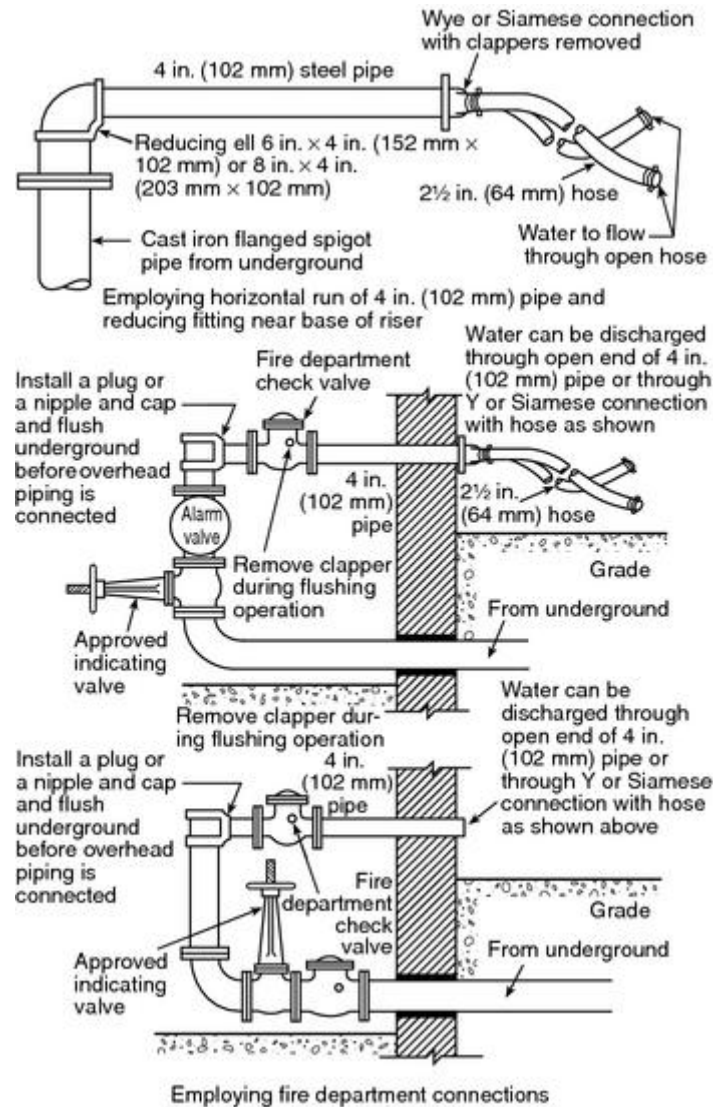

FIGURE A.10.10.2.1 Methods of Flushing Water Supply Connections. [24:Figure A.10.10.2.1]

A.10.10.2.2.1 A sprinkler system has for its water supply a connection to a public water service main. A 100 psi (6.9 bar) rated pump is installed in the connection. With a maximum normal public water supply of 70 psi (4.8 bar) at the low elevation point of the individual system or portion of the system being tested and a 120 psi (8.3 bar) pump (churn) pressure, the hydrostatic test pressure is 70 psi + 120 psi + 50 psi, or 240 psi (16.5 bar).

To reduce the possibility of serious water damage in case of a break, pressure can be

Copyright NFPA

maintained by a small pump, the main controlling gate meanwhile being kept shut during the test.

Polybutylene pipe will undergo expansion during initial pressurization. In this case, a reduction in gauge pressure might not necessarily indicate a leak. The pressure reduction should not exceed the manufacturer's specifications and listing criteria.

When systems having rigid thermoplastic piping such as CPVC are pressure tested, the sprinkler system should be filled with water. The air should be bled from the highest and farthest sprinklers. Compressed air or compressed gas should never be used to test systems with rigid thermoplastic pipe.

A recommended test procedure is as follows: The water pressure is to be increased in 50 psi (3.4 bar) increments until the test pressure described in 10.10.2.2.1 is attained. After each increase in pressure, observations are to be made of the stability of the joints. These observations are to include such items as protrusion or extrusion of the gasket, leakage, or other factors likely to affect the continued use of a pipe in service. During the test, the pressure is not to be increased by the next increment until the joint has become stable. This applies particularly to movement of the gasket. After the pressure has been increased to the required maximum value and held for 1 hour, the pressure is to be decreased to 0 psi while observations are made for leakage. The pressure is again to be slowly increased to the value specified in 10.10.2.2.1 and held for 1 more hour while observations are made for leakage and the leakage measurement is made.

[24: A.10.10.2.2.1]

A.10.10.2.2.4 One acceptable means of completing this test is to utilize a pressure pump that draws its water supply from a full container. At the completion of the 2-hour test, the amount of water to refill the container can be measured to determine the amount of makeup water. To minimize pressure loss, the piping should be flushed to remove any trapped air. Additionally, the piping should be pressurized for 1 day prior to the hydrostatic test to account for expansion, absorption, entrapped air, and so forth.

The use of a blind flange or skillet is preferred for use when hydrostatically testing segments of new work. Metal-seated valves are susceptible to developing slight imperfections during transport, installation, and operation and thus can be likely to leak more than 1 fl oz (30 ml) per inch of valve diameter per hour. For this reason, the blind flange should be used when hydrostatically testing.

[24: A.10.10.2.2.4]

A.10.10.2.6 Hydrostatic tests should be made before the joints are covered so that any leaks can be readily detected. Thrust blocks should be sufficiently hardened before hydrostatic testing is begun. If the joints are covered with backfill prior to testing, the contractor remains responsible for locating and correcting any leakage in excess of that permitted. [24:

A.10.10.2.2.6]

A.11.1.4.1 See Section A.4.3.

A.11.1.4.2 Appropriate area–density, other design criteria, and water supply requirements should be based on scientifically based engineering analyses that can include submitted fire
Copyright NFPA

testing, calculations, or results from appropriate computational models.

Recommended water supplies anticipate successful sprinkler operation. Because of the small but still significant number of uncontrolled fires in sprinklered properties, which have various causes, there should be an adequate water supply available for fire department use.

A.11.1.5.2(3) When a light hazard occupancy, such as a school, contains separate ordinary hazard rooms no more than 400 ft² (37.2 m²), the hose stream allowance and water supply duration would be that required for a light hazard occupancy.

A.11.1.5.6 For fully sprinklered buildings, if hose valves or stations are provided on a combination sprinkler riser and standpipe for fire department use in accordance with NFPA 14, *Standard for the Installation of Standpipe and Hose Systems*, the hydraulic calculation for the sprinkler system is not required to include the standpipe allowance and should be limited to 50 gpm at each hose valve to a maximum of 100 gpm.

A.11.2.1 The situation frequently arises where a small area of a higher hazard is surrounded by a lesser hazard. For example, consider a 600 ft² (55.7 m²) area consisting of 10 ft (3.05 m) high on-floor storage of cartoned unexpanded plastic commodities surrounded by a plastic injection molding operation in a 15 ft (4.57 m) high building. In accordance with Chapter 12, the density required for the plastic storage must meet the requirements for extra hazard (Group 1) occupancies. The injection molding operation should be considered an ordinary hazard (Group 2) occupancy. In accordance with Chapter 11, the corresponding discharge densities should be 0.3 gpm/ft² (12.2 mm/min) over 2500 ft² (232 m²) for the storage and 0.2 gpm/ft² (8.1 mm/min) over 1500 ft² (139 m²) for the remainder of the area. (Also see Chapter 11 for the required minimum areas of operation.)

If the storage area is not separated from the surrounding area by a wall or partition (*see 11.1.2*), the size of the operating area is determined by the higher hazard storage.

For example, the operating area is 2500 ft² (232 m²). The system must be able to provide the 0.3 gpm/ft² (12.2 mm/min) density over the storage area and 15 ft (4.57 m) beyond. If part of the remote area is outside the 600 ft² (55.7 m²) plus the 15 ft (4.57 m) overlap, only 0.2 gpm/ft² (8.1 mm/min) is needed for that portion.

If the storage is separated from the surrounding area by a floor-to-ceiling/roof partition that is capable of preventing heat from a fire on one side from fusing sprinklers on the other side, the size of the operating area is determined by the occupancy of the surrounding area. In this example, the design area is 1500 ft² (139 m²). A 0.3 gpm/ft² (12.2 mm/min) density is needed within the separated area with 0.2 gpm/ft² (8.1 mm/min) in the remainder of the remote area.

A.11.2.1.1 This approach is based on a general occupancy classification applied to the building or a portion of the building.

A.11.2.2.8 The additional pressure that is needed at the level of the water supply to account for sprinkler elevation is 0.433 psi/ft (0.098 bar/m) of elevation above the water supply.

A.11.2.3.1.4(3) This section is included to compensate for possible delay in operation of sprinklers from fires in combustible concealed spaces found in wood frame, brick veneer, and ordinary construction.

A.11.2.3.1.4(4)(d) Composite wood joists are not considered solid wood joists for the purposes of this section. Their web members are too thin and easily penetrated to adequately compartment a fire in an un-sprinklered space. Application of this item is not affected by the depth of the joist channel except in determining the volume.

A.11.2.3.1.4(4)(e) This exception is intended to apply only when the exposed materials in the space are limited combustible materials or fire retardant-treated wood as defined in NFPA 703, *Standard for Fire Retardant-Treated Wood and Fire-Retardant Coatings for Building Materials*.

A.11.2.3.2.5 Where extended coverage sprinklers are used and the design area (after appropriate increases) is satisfied by five sprinklers, no additional increase is required. With regard to preaction systems, the discharge criteria of Chapter 11 are written based upon the assumption that the release system will activate before the sprinkler system. It is generally accepted that smoke detectors and rate of rise detectors are more sensitive than sprinklers and that fixed temperature release devices with RTIs lower than sprinklers will react faster than sprinklers at similar spacings and locations.

A.11.2.3.2.7 Example 1. A dry pipe sprinkler system (OH₂) in a building with a ceiling slope exceeding 2 in 12 in. (16.6 percent slope). The initial area must be increased 30 percent for the dry pipe system and the resulting area an additional 30 percent for the roof slope. If the point 0.2 gpm/ft² (8.1 mm/min) over 1500 ft² (139 m²) is chosen from Figure 11.2.3.1.1, the 1500 ft² (139 m²) area is increased 450 ft² (42 m²) to 1950 ft² (181 m²), which is then further increased 585 ft² (54 m²). The final discharge criterion is then 0.2 gpm/ft² (8.1 mm/min) over 2535 ft² (236 m²).

Example 2. A wet pipe sprinkler system (light hazard) in a building with a 16 ft 8 in. (5.1 m) ceiling and a slope exceeding two in 12 in. (16.6 percent slope) employs quick-response sprinklers qualifying for a 30 percent reduction as permitted by 11.2.3.2.3. The initial area must be increased 30 percent for the ceiling slope and the resulting area decreased 30 percent for quick-response sprinklers. It does not matter whether the reduction is applied first. If a discharge density of 0.1 gpm/ft² (4.1 mm/min) over 1500 ft² (139 m²) is chosen from Figure 11.2.3.1.1, the 1500 ft² (139 m²) is increased 450 ft² (42 m²), resulting in 1950 ft² (181 m²), which is then decreased 585 ft² (54 m²). The final design is 0.1 gpm/ft² (4.1 mm/min) over 1365 ft² (126.8 m²).

A.11.2.3.3.1 This subsection allows for calculation of the sprinklers in the largest room, so long as the calculation produces the greatest hydraulic demand among selection of rooms and communicating spaces. For example, in a case where the largest room has four sprinklers and a smaller room has two sprinklers but communicates through unprotected openings with three other rooms, each having two sprinklers, the smaller room and group of communicating spaces should also be calculated.

Corridors are rooms and should be considered as such.

Walls can terminate at a substantial suspended ceiling and need not be extended to a rated floor slab above for this section to be applied.

A.11.2.3.4.2 This section is intended to apply to all types of systems including dry pipe and

preaction systems.

A.11.3.1.1 The protection area for residential sprinklers with extended coverage areas is defined in the listing of the sprinkler as a maximum square or rectangular area. Listing information is presented in even 2 ft (0.61 m) increments from 12 ft to 20 ft (3.6 m to 6.1 m) for residential sprinklers. When a sprinkler is selected for an application, its area of coverage must be equal to or greater than both the length and width of the hazard area. For example, if the hazard to be protected is a room 14 ft 6 in. (4.3 m) wide and 20 ft 8 in. (6.2 m) long, a sprinkler that is listed to protect an area of 16 ft × 22 ft (4.9 m × 6.8 m) must be selected. The flow used in the calculations is then selected as the flow required by the listing for the selected coverage. (See Figure A.11.3.1.1.)

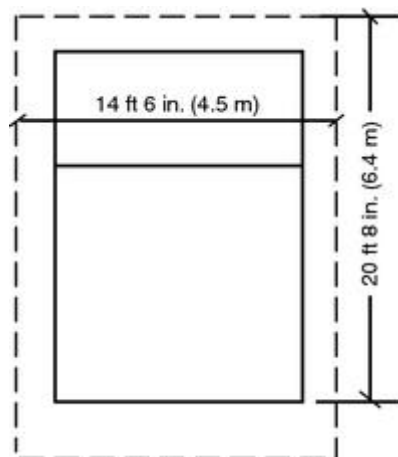

FIGURE A.11.3.1.1 Determination of Protection Area of Coverage for Residential Sprinklers.

A.11.3.1.2 In Figure A.11.3.1.2, calculate the area indicated by the heavy outline and X. The circle indicates sprinklers.

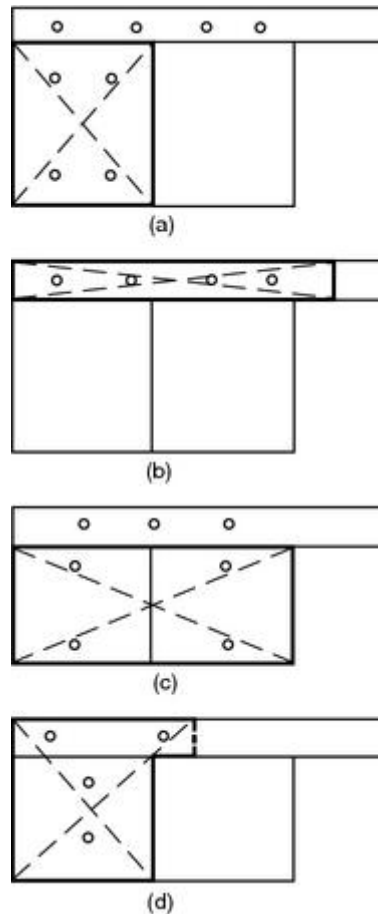

FIGURE A.11.3.1.2 Examples of Design Area for Dwelling Units.

A.11.3.2.1 If the system is a deluge type, all the sprinklers need to be calculated even if they are located on different building faces.

A.12.1.3.4 Almost all of the older testing on which much of the original protection schemes are based were conducted with a maximum clearance from top of storage to ceiling sprinklers of 10 ft (3.05 m). They were also conducted with K-5.6 and/or K-8.0 orifice sprinklers. However, even though the test data were published, few limits for clearance were ever put into the body of the storage standards and it was left up to the authority having jurisdiction to handle as best they could with little test data or loss data available when clearances exceeded 10 ft (3.05 m).

Clearance limitations were within the body of the standard for large drop and larger orifices as well as for ESFR sprinklers when they were developed and tested. The clearance limits suggested for smaller orifice sprinklers are mostly based on some limited loss experience and a few proprietary tests.

Testing has shown that when greater than 10 ft (3.05 m) clearance is inevitable, larger orifice sprinklers (K-5.6 and larger) will produce better results than smaller orifice sprinklers due to larger droplets penetrating the fire plume and/or more water discharging, thereby creating more cooling of atmosphere and building and more water penetration to the burning surfaces. Therefore, using larger orifice sprinklers is normally better not only as density

requirements go higher but also as clearances exceed 10 ft (3.05 m).

Where the ceiling is more than 10 ft (3.1 m) above the maximum height of storage, a horizontal barrier should be installed above storage with one line of sprinklers under the barrier for Classes I, II, and III commodities and two lines of sprinklers under the barrier for Class IV commodities and Group A plastics. In-rack sprinkler arrays should be installed as indicated in Table 16.3.1.1 and Figure 16.3.4.1.1(a) through Figure 16.3.4.1.1(j).

Barriers should be of sufficient strength to avoid sagging that interferes with loading and unloading operations.

Horizontal barriers are not required to be provided above a Class I or Class II commodity with in-rack sprinkler arrays in accordance with Figure 16.3.4.1.1(a) and Figure 16.3.4.1.1(b), provided one line of in-rack sprinklers is installed above the top tier of storage.

A.12.2 Authorities having jurisdiction have varying requirements for plant first aid and fire fighting operations. Examples include (1) no hose stations, (2) hose stations with hose line and nozzles, and (3) hose stations with no hose line or nozzles.

A.12.3 The situation frequently arises where a small area of a higher hazard is surrounded by a lesser hazard. For example, consider a 600 ft² (55.7 m²) area consisting of 10 ft (3.05 m) high on-floor storage of cartoned unexpanded plastic commodities surrounded by a plastic injection molding operation in a 15 ft (4.57 m) high building. In accordance with Chapter 12, the density required for the plastic storage must meet the requirements for extra hazard (Group 1) occupancies. The injection molding operation should be considered an ordinary hazard (Group 2) occupancy. In accordance with Chapter 11, the corresponding discharge densities should be 0.3 gpm/ft² (12.2 mm/min) over 2500 ft² (232 m²) for the storage and 0.2 gpm/ft² (8.1 mm/min) over 1500 ft² (139 m²) for the remainder of the area. (Also see Chapter 11 for the required minimum areas of operation.)

If the storage area is not separated from the surrounding area by a wall or partition (*see 11.1.2*), the size of the operating area is determined by the higher hazard storage.

For example, the operating area is 2500 ft² (232 m²). The system must be able to provide the 0.3 gpm/ft² (12.2 mm/min) density over the storage area and 15 ft (4.57 m) beyond. If part of the remote area is outside the 600 ft² (55.7 m²) plus the 15 ft (4.57 m) overlap, only 0.2 gpm/ft² (8.1 mm/min) is needed for that portion.

If the storage is separated from the surrounding area by a floor-to-ceiling/roof partition that is capable of preventing heat from a fire on one side from fusing sprinklers on the other side, the size of the operating area is determined by the occupancy of the surrounding area. In this example, the design area is 1500 ft² (139 m²). A 0.3 gpm/ft² (12.2 mm/min) density is needed within the separated area with 0.2 gpm/ft² (8.1 mm/min) in the remainder of the remote area.

Where high temperature-rated sprinklers are installed at the ceiling, high temperature-rated sprinklers also should extend beyond storage in accordance with Table A.12.3.

**Table A.12.3 Extension of Installation of
High-Temperature Sprinklers over Storage**

example, the design area is 1500 ft² (139 m²). A 0.3 gpm/ft² (12.2 mm/min) density is needed within the separated area with 0.2 gpm/ft² (8.1 mm/min) in the remainder of the remote area.

Where high temperature-rated sprinklers are installed at the ceiling, high temperature-rated sprinklers also should extend beyond storage in accordance with Table A.12.3.

Table A.12.3 Extension of Installation of High-Temperature Sprinklers over Storage

Design Area for High Temperature-Rated Sprinklers		Distance Beyond Perimeter of High-Hazard Occupancy for High Temperature-Rated Sprinklers	
		ft	m
2000	185.8	30	9.14
3000	278.7	40	12.2
4000	371.6	45	13.72
5000	464.5	50	15.24
6000	557.4	55	16.76

A.12.4 Wet systems are recommended for storage occupancies. Dry pipe systems should be permitted only where it is impractical to provide heat.

A.12.4.2 Wet systems are recommended for rack storage occupancies. Dry systems are permitted only where it is impractical to provide heat. Preaction systems should be considered for rack storage occupancies that are unheated, particularly where in-rack sprinklers are installed or for those occupancies that are highly susceptible to water damage.

A.12.6 The reasons for using larger orifice sprinklers in storage situations are based on a number of fire tests in recent years that continue to show an advantage of the larger orifice [K-11.2 (161) and K-16.8 (242)] sprinklers over the K-5.6 (80) and even the K-8 (115) orifice sprinklers. Following are four sets of fire test comparisons using constant densities. [See Table A.12.6(a) and Table A.12.6(b).]

Table A.12.6(a) Ceiling Type

Fire Type	Ceiling Type	Sprinkler Distance Below Ceiling (in.)	Time to Activation (seconds)	Size of Fire at Activation (Btu/s)
Fast-growing fire	Insulated deck	1	76	450
	Steel	1	97	580
	Wood	1	71	420
	Insulated deck	12	173	1880
	Steel	12	176	1930
	Wood	12	172	1900

Table A.12.6(a) Ceiling Type

Fire Type	Ceiling Type	Sprinkler Distance Below Ceiling (in.)	Time to Activation (seconds)	Size of Fire at Activation (Btu/s)
Slow-growing fire	Insulated deck	1	281	220
	Steel	1	375	390
	Wood	1	268	200
	Insulated deck	12	476	630
	Steel	12	492	675
	Wood	12	473	620

Table A.12.6(b) Ceiling Arrangement

Situation	Fire	Time to Activate Sprinkler (seconds)	Fire Size at Time of Activation (Btu/s)
Ceiling with pocket	Fast	86 to 113	585
Sprinkler 12 in. below ceiling	Fast	172 to 176	1880 to 1900
Ceiling with pocket	Slow	288 to 395	490
Sprinkler 12 in. below ceiling	Slow	473 to 492	620 to 675

- (1) K-5.6 vs. K-11.2
 - (a) Commodity — idle wood two-way pallets
 - (b) 2 stacks × 3 stacks × 8 ft high
 - (c) Ceiling height — 30 ft
 - (d) Density — constant 0.30 gpm/ft²
 - (e) Test #1 — 165°F rated, K-11.2 sprinklers
 - (f) Test #2 — 165°F rated, K-5.6 sprinklers
 - (g) Test #1 results — 4 A.S. operated
 - (h) Test #2 results — 29 A.S. operated, less fire control and greater temperatures
- (2) K-8.0 vs. K-11.2 vs. K-16.8
 - (a) Commodity — idle wood four-way pallets
 - (b) Two stacks × three stacks × 12 ft high
 - (c) Ceiling height — 30 ft

- (d) Density — constant 0.6 gpm/ft²
 - (e) Test #1 — 286°F rated, K-8 sprinklers
 - (f) Test #2 — 165°F rated, K-11.2 sprinklers
 - (g) Test #3 — 165°F rated, K-16.8 sprinklers
 - (h) Test #1 results — 10 A.S. operated, 658°C maximum steel temperature, fire spread to all sides
 - (i) Test #2 results — 13 A.S. operated, 94°C maximum steel temperature, fire spread to three sides
 - (j) Test #3 results — 6 A.S. operated, 54°C maximum steel temperature, fire spread (just reached) one side
- (3) K-5.6 vs. K-16.8
- (a) Commodity — FMRC standard plastic commodity rack style 9 ft high
 - (b) Ceiling height — 30 ft
 - (c) Density — 0.45 gpm/ft²
 - (d) Test #1 — K-5.6 orifice sprinklers
 - (e) Test #2 — K-16.8 orifice sprinklers
 - (f) Test #1 results — 29 A.S. operated, 14 pallet loads consumed
 - (g) Test #2 results — 5 A.S. operated, 2 pallet loads consumed
- (4) K-8.0 vs. K-16.8
- (a) Commodity — FMRC standard plastic commodity rack stage 14 ft high
 - (b) Ceiling height — 25 ft
 - (c) Density — 0.60 gpm/ft²
 - (d) Test #1 — K-8.0 sprinklers
 - (e) Test #2 — K-16.8 sprinklers
 - (f) Test #1 results — 29 A.S. operated, 25 pallet loads consumed
 - (g) Test #2 results — 7 A.S. operated, 4 pallet loads consumed

On an equal density basis, the fire test comparisons show the advantage of the larger orifices. A possibly even bigger advantage can be seen when investigating the performance of larger orifice sprinklers in the real world condition of high initial operating pressures.

The volume of water discharged through the larger K-factor for the initial sprinklers has three significant effects:

- (1) First, the increase in sheer volume flowing through the larger orifice enhances performance. For example, a 165 psi initial operating pressure would provide 102.8

gpm from a K-8, while the K-16.8 will discharge 215.8 gpm.

- (2) Second, fire testing at high pressures (100+ psi) with K-5.6 and K-8 (when high fire updrafts occur) has shown less water penetration and more sprinkler skipping. When fire testing the K-11 and K-16.8 sprinklers at 100+ psi, more water penetration is evident and little or no sprinkler skipping has occurred.
- (3) Third, with such high initial discharge rates among K-16.8 sprinklers, the friction loss in the supply pipes would be greater. This would result in lower initial pressures than a K-8 as well as being farther down the water supply curve with greater flows resulting in lower initial operating pressures.

Figure A.12.6 highlights the differences between the K-8 and K-16.8 initial operating pressures.

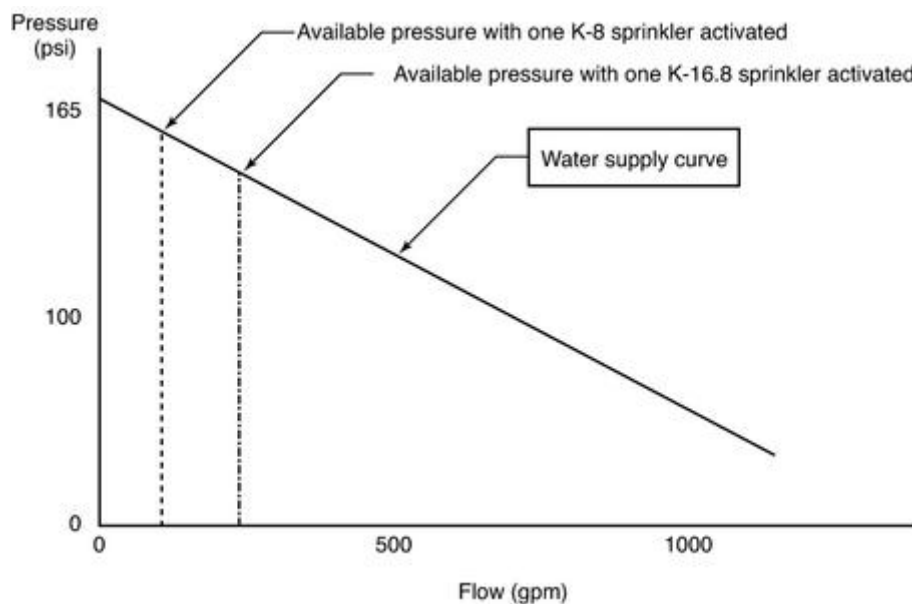

FIGURE A.12.6 Available Pressure Comparison.

The higher flow rate of the K-16.8 sprinkler results in greater friction losses in the initial operating heads as compared to the K-8. Combined with the lower pressure available on the water supply curve, the end result is a self-regulating orifice size allowing greater initial pressures without a negative impact.

Table A.12.6(c) summarizes the paper product testing.

Table A.12.6(c) Paper Product Testing Results

Test Date	3/25/98	3/18/98*	4/4/98	6/4/98†
Sprinklers	K-8	K-8	K-11	K-17-231
Temperature	286°F	286°F	165°F	155°F
Storage Type	4 tier pyramid	5 tier pyramid	4 tier pyramid	5 tier pyra
Storage Height	16 ft	22 ft	16 ft	22 ft
Ceiling Height	30 ft	31 ft	30 ft	31 ft
Sprinkler Flow Pressure	22.6 psi	175 psi	11.9 psi	130 psi

Copyright NFPA

Table A.12.6(c) Paper Product Testing Results

Test Date	3/25/98	3/18/98*	4/4/98	6/4/98†
Number of Operated Sprinklers	15	2	10	2
Peak Gas Temperature	—	868°F	—	424°F
Peak Steel Temperature	—	421°F	—	113°F
Fire Spread Across Aisle (30 in.)	N/A	Yes	N/A	No

*This test was run with a fire brigade response of 20:00 minutes.

†This test was run with a fire brigade response of 7:00 minutes.

The results: The tests indicated that even at a high temperature of 286°F, the K-8 sprinklers operating at higher pressures were not effective in controlling the fire. Conversely, the K-16.8 was able to control the fire at the lower temperature [155°F (68°C)], by operating sooner, and at lower, self-regulating flowing pressures.

Conclusions: The larger K-factor of the K-16.8 is not affected by high initial operating pressures. In fact, the protection is enhanced, providing better fire protection.

The ability to use lower rated temperatures, such as 155°F (68°C) in lieu of 286°F (141°C), shows that the performance of the initial operating sprinklers is effective in controlling the fire. Therefore, using high-temperature heads to reduce the number of surrounding rings of sprinklers to open is not necessary when using the K-16.8 technology.

In short, the K-16.8 proved highly effective when subjected to high initial operating pressures.

A.12.6.4 Modification of an existing system includes extending sprinkler protection into adjacent areas.

A.12.7.2 When a light hazard occupancy, such as a school, contains separate ordinary hazard storage rooms no more than 400 ft² (37.2 m²), the hose stream demand would be that required for a light hazard occupancy.

A.12.7.2(3) When a light hazard occupancy, such as a school, contains separate ordinary hazard rooms no more than 400 ft² (37.2 m²), the hose stream allowance and water supply duration would be that required for a light hazard occupancy.

A.12.9.2(4) Composite wood joists are not considered solid wood joists for the purposes of this section. Their web members are too thin and easily penetrated to adequately compartment a fire in an unsprinklered space. Application of this item is not affected by the depth of the joist channel except in determining the volume.

A.12.9.2(5) This allowance is intended to apply only when the exposed materials in the space are limited combustible materials or fire retardant-treated wood as defined in NFPA 703, *Standard for Fire Retardant-Treated Wood and Fire-Retardant Coatings for Building Materials*.

A.12.10.1 This subsection allows for calculation of the sprinklers in the largest room, so long as the calculation produces the greatest hydraulic demand among selection of rooms

and communicating spaces. For example, in a case where the largest room has four sprinklers and a smaller room has two sprinklers but communicates through unprotected openings with three other rooms, each having two sprinklers, the smaller room and group of communicating spaces should also be calculated.

Corridors are rooms and should be considered as such.

Walls can terminate at a substantial suspended ceiling and need not be extended to a rated floor slab above for this section to be applied.

A.12.11 Detection systems, concentrate pumps, generators, and other system components that are essential to the operation of the system should have an approved standby power source.

Where high-expansion foam is contemplated as the protection media, consideration should be given to possible damage to the commodity from soaking and corrosion. Consideration also should be given to the problems associated with the removal of the foam after discharge.

A.12.12 Idle pallet storage introduces a severe fire condition. Stacking idle pallets in piles is the best arrangement of combustibles to promote rapid spread of fire, heat release, and complete combustion. After pallets are used for a short time in warehouses, they dry out and edges become frayed and splintered. In this condition, they are subject to easy ignition from a small ignition source. Again, high piling increases considerably both the challenge to sprinklers and the probability of involving a large number of pallets when fire occurs. Therefore, it is preferable to store pallets outdoors where possible.

A fire in stacks of idle plastic or wood pallets is one of the greatest challenges to sprinklers. The undersides of the pallets create a dry area on which a fire can grow and expand to other dry or partially wet areas. This process of jumping to other dry, closely located, parallel, combustible surfaces continues until the fire bursts through the top of the stack. Once this happens, very little water is able to reach the base of the fire. The only practical method of stopping a fire in a large concentration of pallets with ceiling sprinklers is by means of prewetting. In high stacks, this cannot be done without abnormally high water supplies. The storage of empty wood pallets should not be permitted in an unsprinklered warehouse containing other storage.

A.12.12.1.1 Table A.12.12.1.1 gives recommended clearances between outside idle wood pallet storage and a building. If plastic pallets are stored outdoors, consideration should be given to the anticipated radiated heat produced by the materials used to construct the pallet to establish the appropriate separation distance.

Table A.12.12.1.1 Recommended Clearance Between Outside Idle Wood Pallet Storage and a Building

Wall Type	Wall Construction Openings	Minimum I	
		Under 50 Pallets	
		ft	m
Masonry	None	0	0
	Wired glass with outside sprinklers and 1-hour doors	0	0
	Wired or plain glass with outside sprinklers and ¾-hour doors	10	3.1

Table A.12.12.1.1 Recommended Clearance Between Outside Idle Wood Pallet

Wall Construction		Minimum I	
		Under 50 Pallets	
Wall Type	Openings	ft	m
Wood or metal with outside sprinklers		10	3.1
Wood, metal, or other		20	6.1

Notes:

- (1) Fire-resistive protection comparable to that of the wall also should be provided for combustible eaves lines,
- (2) Where pallets are stored close to a building, the height of storage should be restricted to prevent burning pallets,
- (3) Manual outside open sprinklers generally are not a reliable means of protection unless property is attended personnel.
- (4) Open sprinklers controlled by a deluge valve are preferred.

A.12.12.1.2 No additional protection is necessary, provided the requirements of 12.12.1.2 are met.

A.14.1.1 Appropriate area/density, other design criteria, and water supply requirements should be based on scientifically based engineering analyses that can include submitted fire testing, calculations, or results from appropriate computational models.

Recommended water supplies anticipate successful sprinkler operation. Because of the small but still significant number of uncontrolled fires in sprinklered properties, which have various causes, there should be an adequate water supply available for fire department use.

A.14.2 The following procedure should be followed in determining the proper density and area as specified in Chapter 12:

- (1) Determine the commodity class.
- (2) Select the density and area of application.
- (3) Adjust the required density for storage height.
- (4) Increase the operating area by 30 percent where a dry pipe system is used.
- (5) Satisfy the minimum densities and areas.

Example:

Storage — greeting cards in boxes in cartons on pallets

Height — 22 ft (6.7 m)

Clearance — 6 ft (1.8 m)

Sprinklers — ordinary temperature

System type — dry

- (a) Classification — Class III
- (b) Selection of density/area — 0.225 gpm/ft² (9.2 mm/min) over 3000 ft² (279 m²)
- (c) Adjustment for height of storage — $1.15 \times 0.225 \text{ gpm/ft}^3$ (9.17 mm/min) = 0.259 gpm/ft² (10.553 mm/min), rounded up to 0.26 gpm/ft² (10.6 mm/min)

(d) Adjustment of area of operation for dry system — $1.3 \times 3000 \text{ ft}^2$ (279 m²) = 3900 ft² (363 m²)

(e) Confirmation that minimum densities and areas have been achieved

The minimum design density for a dry sprinkler system is 0.15 gpm/ft² over 2600 ft² (6.1 mm/min over 242 m²) for Class III.

The corresponding minimum density at 3000 ft² (279 m²) is 0.17 gpm/ft² (6.9 mm/min) (satisfied); $1.3 \times 3000 \text{ ft}^2 = 3900 \text{ ft}^2$ (363 m²), 0.17 gpm/ft² (6.9 mm/min) over 3900 ft² (363 m²).

The design density and area of application equals 0.26 gpm/ft² over 3900 ft² (10.6 mm/min over 363 m²).

A.14.2.1(3) Full-scale tests show no appreciable difference in the number of sprinklers that open for either nonencapsulated or encapsulated products up to 15 ft (4.6 m) high. Test data are not available for encapsulated products stored higher than 15 ft (4.6 m). However, in rack storage tests involving encapsulated storage 20 ft (6.1 m) high, increased protection was needed over that for nonencapsulated storage.

The protection specified contemplates a maximum of 10 ft (3 m) clearances from top of storage to sprinkler deflectors for storage heights of 15 ft (4.6 m) and higher.

A.15.1.2 An evaluation for each field situation should be made to determine the worst applicable height–clearance relationship that can be expected to appear in a particular case. Fire tests have shown that considerably greater demands occur where clearance is 10 ft (3.1 m) as compared to 3 ft (0.9 m) and where a pile is stable as compared to an unstable pile. Since a system is designed for a particular clearance, the system could be inadequate when significant areas do not have piling to the design height and larger clearances exist between stock and sprinklers. This can also be true where the packaging or arrangement is changed so that stable piling is created where unstable piling existed. Recognition of these conditions is essential to avoid installation of protection that is inadequate or becomes inadequate because of changes.

No tests were conducted simulating a peaked roof configuration. However, it is expected that the principles of Chapter 12 still apply. The worst applicable height–clearance relationship that can be expected to occur should be found, and protection should be designed for it. If storage is all at the same height, the worst height–clearance relationship creating the greatest water demand would occur under the peak. If commodities are stored higher under the peak, the various height–clearance relationships should be tried and the one creating the greatest water demand used for designing protection.

A.15.2 The densities and area of application have been developed from fire test data. Most of these tests were conducted with K-8 orifice sprinklers and 80 ft² or 100 ft² (7.4 m² or 9.3 m²) sprinkler spacing. These and other tests have indicated that, with densities of 0.4 gpm/ft² (16.3 mm/min) and higher, better results are obtained with K-8 orifice and 70 ft² to 100 ft² (7.4 m² to 9.3 m²) sprinkler spacing than where using K-5.6 orifice sprinklers at 50 ft² (4.6 m²) spacing. A discharge pressure of 100 psi (6.9 bar) was used as a starting point on one of the fire tests. It was successful, but has a 1½ ft (0.5 m) clearance between the top of storage

and ceiling sprinklers. A clearance of 10 ft (3 m) could have produced a different result due to the tendency of the higher pressure to atomize the water and the greater distance that the fine water droplets had to travel to the burning fuel.

Table A.15.2 explains and provides an example of the method and procedure to follow in using this standard to determine proper protection for Group A plastics.

Table A.15.2 Metric Conversion Factors for Examples

To Convert from	to	Multiply by
feet (ft)	meters (m)	0.3048
square feet (ft ²)	square meters (m ²)	0.0929
gallons/minute (gpm)	liters/second (L/sec)	0.0631
gallons per minute per square foot (gpm/ft ²)	millimeters per minute (same as liters per minute per square meter) (mm/min)	40.746

Example 1. Storage is expanded, cartoned, stable, 15 ft (4.6 m) high in a 20 ft (6.1 m) building.

Answer 1. Column E of Table 15.2.5(a) — Design density is 0.45 gpm/ft² (18.3 mm/min).

Example 2. Storage is nonexpanded, unstable, 15 ft (4.6 m) high in a 20 ft (6.1 m) building.

Answer 2. Column A of Table 15.2.5(a) — Design density is listed as 0.25 gpm/ft² (10.2 mm/min); however, it is also possible that the storage can be 12 ft (3.66 m) in this 20 ft (6.1 m) building, which would require a design density of 0.3 (12.2 mm/min). Unless the owner can guarantee that the storage will always be 15 ft (4.6 m), the design density = 0.3 gpm/ft² (12.2 mm/min).

Example 3. Storage is a nonexpanded, stable 15 ft (4.6 m) fixed-height unit load, one high, in an 18 ft (5.5 m) building.

Answer 3. Column A of Table 15.2.5(a) — Design density is 0.25 gpm/ft² (10.2 mm/min). Note that this design density does not increase to 0.3 gpm/ft² (12.2 mm/min) as in the previous example because of the use of a fixed-height unit load. The storage height will never be 12 ft (3.66 m). It will always be 15 ft (4.6 m).

Example 4. Storage is expanded, exposed, unstable, 20 ft (6.1 m) high in a 27 ft (8.2 m) building.

Answer 4. Column C of Table 15.2.5(a) — Design density is 0.7 gpm/ft² (28.5 mm/min). Note that other lower storage heights should also be checked, but they reveal the same, or lower, densities [0.7 gpm/ft² and 0.6 gpm/ft² (28.5 mm/min and 24.5 mm/min)], so the design density remains at 0.7 gpm/ft² (28.5 mm/min).

Example 5. Storage is expanded, cartoned, unstable, 17 ft (5.2 m) high in 32 ft (9.75 m) building.

Answer 5. Column D of Table 15.2.5(a) — 15 ft (4.6 m) storage in a 32 ft (9.75 m) building

would be 0.55 gpm/ft² (22.4 mm/min); 20 ft (6.1 m) storage in a 32 ft (9.75 m) building would be 0.7 gpm/ft² (28.5 mm/min). Interpolation for 17 ft (5.2 m) storage is as follows:

$$\begin{aligned}0.7 - 0.55 &= 0.15 \\ \frac{0.15}{(20 - 15)} &= 0.03 \\ 0.03 \times (17 - 15) &= 0.06 \\ 0.55 + 0.06 &= 0.61\end{aligned}$$

Design density = 0.61 gpm/ft² (24.9 mm/min)

Example 6. Storage is expanded, exposed, stable, 22 ft (6.71 m) high in a 23½ ft (7.16 m) building.

Answer 6. Column B of Table 15.2.5(a) — Could interpolate between 0.6 gpm/ft² and 0.75 gpm/ft² (24.5 mm/min and 30.6 mm/min); however, this would be a moot point since the density for 15 ft (4.6 m) storage in this 23½ ft (7.16 m) building would be 0.8 gpm/ft² (32.6 mm/min). Unless the owner can guarantee 22 ft (6.71 m) storage, the design density is 0.8 gpm/ft² (32.6 mm/min). If the owner can, in a manner acceptable to the authority having jurisdiction, guarantee 22 ft (6.71 m) storage, the interpolation would yield a design density of 0.66 gpm/ft² (26.9 mm/min).

Example 7. Storage is nonexpanded, stable, exposed, 13½ ft (4.1 m) high in a 15 ft (4.6 m) building.

Answer 7. Column E of Table 15.2.5(a) — 12 ft (3.66 m) storage in a 15 ft (4.6 m) building would be extra hazard, Group 2 [0.4 gpm/ft² over 2500 ft² (16.3 mm/min over 230 m²)].

Storage 15 ft (4.6 m) high in a 15 ft (4.6 m) building would be 0.45 gpm/ft² (18.3 mm/min). Interpolation for 13½ ft (4.1 m) storage is as follows:

$$\begin{aligned}0.45 - 0.4 &= 0.05 \\ \frac{0.05}{(15 - 12)} &= 0.017 \\ 0.017 \times (13.5 - 12) &= 0.026 \\ 0.4 + 0.026 &= 0.426\end{aligned}$$

Design density = 0.426 gpm/ft² (17.4 mm/min)

A.15.2.1 Two direct comparisons between ordinary temperature– and high temperature–rated sprinklers are possible, as follows:

- (1) With nonexpanded polyethylene 1 gal (3.8 L) bottles in corrugated cartons, a 3 ft (0.9 m) clearance, and the same density, approximately the same number of sprinklers operated (nine at high temperature versus seven at ordinary temperature)
- (2) With exposed, expanded polystyrene meat trays, a 9.5 ft (1.9 m) clearance, and the same density, three times as many ordinary temperature–rated sprinklers operated as did high temperature–rated sprinklers (11 at high temperature versus 33 at ordinary temperature)

The cartoned plastics requirements of this standard are based to a great extent on test work that used a specific commodity — 16 oz (0.473 L) polystyrene plastic jars individually separated by thin carton stock within a large corrugated carton [3½ ft² (0.32 m²)]. [See *Figure A.15.2.1(a).*]

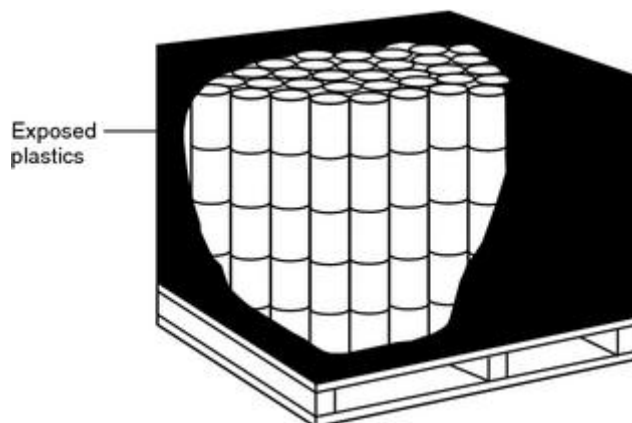

FIGURE A.15.2.1(a) Corrugated Carton Containing Individually Separated Plastic Jars.

Other Group A plastic commodities can be arranged in cartons so that they are separated by multiple thicknesses of carton material. In such arrangements, less plastic becomes involved in the fire at any one time. This could result in a less vigorous fire that can be controlled by Class IV commodity protection.

Other situations exist in which the plastics component is surrounded by several layers of less hazardous material and is therefore temporarily protected or insulated from a fire involving adjacent plastic products. Such conditions also could produce a less vigorous fire and be successfully handled by Class IV protection. [See *Figure A.15.2.1(b).*]

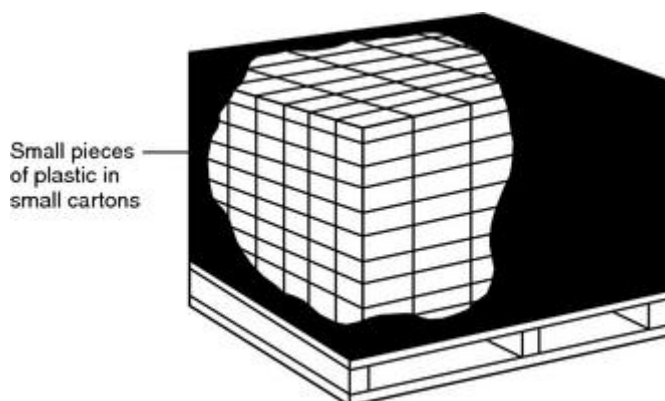

FIGURE A.15.2.1(b) Corrugated Carton Containing Plastic Pieces Individually Separated by Carton Material.

The decision to protect as a Class IV commodity, however, should be made only based on experienced judgment and only with an understanding of the consequences of underprotecting the storage segment.

A.15.2.2 There are few storage facilities in which the commodity mix or storage arrangement remains constant, and a designer should be aware that the introduction of different materials can change protection requirements considerably. Design should be based on higher densities and areas of application, and the various reductions allowed should be applied cautiously. For evaluation of existing situations, however, the allowances can be quite helpful.

A.15.2.5 Test data are not available for all combinations of commodities, storage heights, and clearances. Some of the protection criteria in this standard are based on extrapolations of test data for other commodities and storage configurations, as well as available loss data.

For example, there are very limited test data for storage of expanded plastics higher than 20 ft (6.1 m). The protection criteria in this standard for expanded plastics higher than 20 ft (6.1 m) are extrapolated from test data for expanded plastics storage 20 ft (6.1 m) and less in height and test data for unexpanded plastics above 20 ft (6.1 m).

Further examples can be found in the protection criteria for clearances up to 15 ft (4.6 m). Test data are limited for clearances greater than 10 ft (3.1 m). It should be assumed that, if protection is adequate for a given storage height in a building of a given height, the same protection will protect storage of any lesser height in the same building. For example, protection adequate for 20 ft (6.1 m) storage in a 30 ft (9.1 m) building [10 ft (3.1 m) clearance] would also protect 15 ft (4.6 m) storage in a 30 ft (9.1 m) building [15 ft (4.6 m) clearance]. Therefore, the protection criteria in Table 15.2.5(a) for 15 ft (4.6 m) clearance are based on the protection criteria for storage 5 ft (1.5 m) higher than the indicated height with 10 ft (3.1 m) clearance.

Table 15.2.5(a) is based on tests that were conducted primarily with high temperature-rated, K-8 orifice sprinklers. Other tests have demonstrated that, where sprinklers are used with orifices greater than K-8, ordinary-temperature sprinklers are acceptable.

A.16.1.2 The fire protection system design should consider the maximum storage height. For new sprinkler installations, maximum storage height is the usable height at which commodities can be stored above the floor while the minimum required unobstructed space below sprinklers is maintained. Where evaluating existing situations, maximum storage height is the maximum existing storage height if space between the sprinklers and storage is equal to or greater than that required.

A.16.1.2.2 Information for the protection of Classes I, II, III, and IV commodities was extrapolated from full-scale fire tests that were performed at different times than the tests that were used to develop the protection for plastic commodities. It is possible that, by selecting certain points from the tables (and after applying the appropriate modifications), the protection specified by 16.2.4.1 exceeds the requirements of Section 17.2. In such situations, the protection specified for plastics, although less than that required by the tables, can adequately protect Classes I, II, III, and IV commodities.

This section also allows storage areas that are designed to protect plastics to store Classes I, II, III, and IV commodities without a re-evaluation of fire protection systems.

A.16.1.9 Where the ceiling is more than 10 ft (3.1 m) above the maximum height of storage,

a horizontal barrier should be installed above storage with one line of sprinklers under the barrier for Classes I, II, and III commodities and two lines of sprinklers under the barrier for Class IV commodities and Group A plastics. In-rack sprinkler arrays should be installed as indicated in Table 16.3.1.1 and Figure 16.3.4.1.1(a) through Figure 16.3.4.1.1(j).

Barriers should be of sufficient strength to avoid sagging that interferes with loading and unloading operations.

Horizontal barriers are not required to be provided above a Class I or Class II commodity with in-rack sprinkler arrays in accordance with Figure 16.3.4.1.1(a) and Figure 16.3.4.1.1(b), provided one line of in-rack sprinklers is installed above the top tier of storage.

A.16.2.1.3.1 Bulkheads are not a substitute for sprinklers in racks. Their installation does not justify reduction in sprinkler densities or design operating areas as specified in the design curves.

A.16.2.1.3.2 Data indicate that the sprinkler protection criteria in Figure 16.2.1.3.2(b) through Figure 16.2.1.3.2(g) are ineffective, by themselves, for rack storage with solid shelves, if the required flue spaces are not maintained. Use of Figure 16.2.1.3.2(b) through Figure 16.2.1.3.2(g), along with the additional provisions that are required by this standard, can provide acceptable protection.

A.16.2.1.3.2.1 The aisle width and the depth of racks are determined by material-handling methods. The widths of aisles should be considered in the design of the protection system. Storage in aisles can render protection ineffective and should be discouraged.

A.16.2.1.3.5 Appropriate area/density, other design criteria, and water supply requirements should be based on scientifically based engineering analyses that can include submitted fire testing, calculations, or results from appropriate computational models.

Recommended water supplies anticipate successful sprinkler operation. Because of the small but still significant number of uncontrolled fires in sprinklered properties, which have various causes, there should be an adequate water supply available for fire department use.

A.16.2.3 ESFR sprinklers are designed to respond quickly to growing fires and deliver heavy discharge to suppress fires rather than to control them. ESFR sprinklers should not be relied on to provide suppression if they are used outside the design parameters.

While these sprinklers are intended primarily for use in high-pile storage situations, this section permits their use and extension into adjacent portions of an occupancy that might have a lesser classification.

Storage in single-story or multistory buildings can be permitted, provided the maximum ceiling/roof height as specified in Chapter 12 is satisfied for each storage area.

Design parameters were determined from a series of full-scale fire tests that were conducted as a joint effort between Factory Mutual Research Corporation and the National Fire Protection Research Foundation. (Copies of the test reports are available from the NFPRF.)

A.16.2.4.2.1 Spacing of sprinklers on branch lines in racks in the various tests demonstrates that maximum spacing as specified is proper.

A.16.2.4.2.2 In-rack sprinklers at one level only for storage up to and including 25 ft (7.6 m) in multiple-row racks should be located at the tier level nearest one-half to two-thirds of the storage height.

A.16.2.4.2.3 Where possible, it is recommended that in-rack sprinkler deflectors be located at least 6 in. (152.4 mm) above pallet loads.

A.16.2.4.2.4 Where possible, it is recommended that in-rack sprinklers be located away from rack uprights.

A.16.2.5.1.1 Slatting of decks or walkways or the use of open grating as a substitute for automatic sprinkler thereunder is not acceptable.

In addition, where shelving of any type is employed, it is for the basic purpose of providing an intermediate support between the structural members of the rack. As a result, it becomes almost impossible to define and maintain transverse flue spaces across the rack as required.

A.16.3.1.1 Water demand for storage height over 25 ft (7.6 m) on racks without solid shelves separated by aisles at least 4 ft (1.2 m) wide and with more than 10 ft (3.1 m) between the top of storage and the sprinklers should be based on sprinklers in a 2000 ft² (186 m²) operating area for double-row racks and a 3000 ft² (278.7 m²) operating area for multiple-row racks discharging a minimum of 0.18 gpm/ft² (7.33 mm/min) for Class I commodities, 0.21 gpm/ft² (8.56 mm/min) for Classes II and III commodities, and 0.25 gpm/ft² (10.2 mm/min) for Class IV commodities for ordinary temperature-rated sprinklers or a minimum of 0.25 gpm/ft² (10.2 mm/min) for Class I commodities, 0.28 gpm/ft² (11.41 mm/min) for Classes II and III commodities, and 0.32 gpm/ft² (13.04 mm/min) for Class IV commodities for high temperature-rated sprinklers. (*See A.16.1.9 and A.16.3.4.1.3.*)

Where such storage is encapsulated, ceiling sprinkler density should be 25 percent greater than for nonencapsulated storage.

Data indicate that the sprinkler protection criteria in 16.3.1.1 are ineffective, by themselves, for rack storage with solid shelves if the required flue spaces are not maintained. Use of 16.3.1.1, along with the additional provisions that are required by this standard, can provide acceptable protection.

A.16.3.3 ESFR sprinklers are designed to respond quickly to growing fires and deliver heavy discharge to suppress fires rather than to control them. ESFR sprinklers should not be relied on to provide suppression if they are used outside the design parameters.

While these sprinklers are intended primarily for use in high-pile storage situations, this section permits their use and extension into adjacent portions of an occupancy that might have a lesser classification.

Storage in single-story or multistory buildings can be permitted, provided the maximum ceiling/roof height as specified in Chapter 12 is satisfied for each storage area.

Design parameters were determined from a series of full-scale fire tests that were conducted as a joint effort between Factory Mutual Research Corporation and the National Fire Protection Research Foundation. (Copies of the test reports are available from the NFPRF.)

A.16.3.4.1.1 Where storage tiers are not the same size on each side of the longitudinal flue, one side of the flue should be protected with sprinklers at the proper elevation above the load. The next level of sprinklers should protect the other side of the flue with the sprinklers at the proper elevation above that load as indicated in Figure A.16.3.4.1.1. The vertical spacing requirements for in-rack sprinklers specified in Table 16.3.1.1 and Section 17.2 for plastics should be followed.

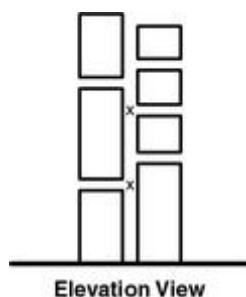

FIGURE A.16.3.4.1.1 Placement of In-Rack Sprinkler Where Rack Levels Have Varying Heights.

A.16.3.4.1.2 In single-row racks with more than 10 ft (3.1 m) between the top of storage and the ceiling, a horizontal barrier should be installed above storage with one line of sprinklers under the barrier.

A.16.3.4.1.3 In multiple-row racks with more than 10 ft (3.1 m) between the maximum height of storage and ceiling, a horizontal barrier should be installed above storage with a level of sprinklers, spaced as stipulated for in-rack sprinklers, installed directly beneath the barrier. In-rack sprinklers should be installed as indicated in Figure 16.3.4.1.3(a) through Figure 16.3.4.1.3(c).

Data indicate that the sprinkler protection criteria in 16.3.4.1.3 are ineffective, by themselves, for rack storage with solid shelves if the required flue spaces are not maintained. Use of Table 16.3.1.2, along with the additional provisions that are required by this standard, can provide acceptable protection.

A.17.1.2.5 Information for the protection of Classes I, II, III, and IV commodities was extrapolated from full-scale fire tests that were performed at different times than the tests that were used to develop the protection for plastic commodities. It is possible that, by selecting certain points from the tables (and after applying the appropriate modifications), the protection specified by 16.2.4.1 exceeds the requirements of Section 17.2. In such situations, the protection specified for plastics, although less than that required by the tables, can adequately protect Classes I, II, III, and IV commodities.

This section also allows storage areas that are designed to protect plastics to store Classes I, II, III, and IV commodities without a re-evaluation of fire protection systems.

A.17.1.7.4 In-rack sprinklers have proven to be the most effective way to fight fires in rack storage. To accomplish this, however, in-rack sprinklers must be located where they will operate early in a fire as well as direct water where it will do the most good. Simply maintaining a minimum horizontal spacing between sprinklers does not achieve this goal,

because fires in rack storage develop and grow in transverse and longitudinal flues, and in-rack sprinklers do not operate until flames actually impinge on them. To ensure early operation and effective discharge, in-rack sprinklers in the longitudinal flue of open-frame racks must be located at transverse flue intersections.

A.17.1.8 Where the ceiling is more than 10 ft (3.1 m) above the maximum height of storage, a horizontal barrier should be installed above storage with one line of sprinklers under the barrier for Classes I, II, and III commodities and two lines of sprinklers under the barrier for Class IV commodities and Group A plastics. In-rack sprinkler arrays should be installed as indicated in Table 16.3.1.1 and Figure 16.3.4.1.1(a) through Figure 16.3.4.1.1(j).

Barriers should be of sufficient strength to avoid sagging that interferes with loading and unloading operations.

Horizontal barriers are not required to be provided above a Class I or Class II commodity with in-rack sprinkler arrays in accordance with Figure 16.3.4.1.1(a) and Figure 16.3.4.1.1(b), provided one line of in-rack sprinklers is installed above the top tier of storage.

A.17.2.1.1 All rack fire tests of plastics were run with an approximate 10 ft (3.1 m) maximum clearance between the top of the storage and the ceiling sprinklers. Within 30 ft (9.1 m) high buildings, greater clearances above storage configurations should be compensated for by the addition of more in-rack sprinklers or the provision of greater areas of application, or both.

A.17.2.1.8 Appropriate area/density, other design criteria, and water supply requirements should be based on scientifically based engineering analyses that can include submitted fire testing, calculations, or results from appropriate computational models.

Recommended water supplies anticipate successful sprinkler operation. Because of the small but still significant number of uncontrolled fires in sprinklered properties, which have various causes, there should be an adequate water supply available for fire department use.

A.17.2.3 ESFR sprinklers are designed to respond quickly to growing fires and deliver heavy discharge to suppress fires rather than to control them. ESFR sprinklers should not be relied on to provide suppression if they are used outside the design parameters.

While these sprinklers are intended primarily for use in high-pile storage situations, this section permits their use and extension into adjacent portions of an occupancy that might have a lesser classification.

Storage in single-story or multistory buildings can be permitted, provided the maximum ceiling/roof height as specified in Chapter 12 is satisfied for each storage area.

Design parameters were determined from a series of full-scale fire tests that were conducted as a joint effort between Factory Mutual Research Corporation and the National Fire Protection Research Foundation. (Copies of the test reports are available from the NFPRF.)

A.17.2.5.1.1 Slating of decks or walkways or the use of open grating as a substitute for automatic sprinkler thereunder is not acceptable.

In addition, where shelving of any type is employed, it is for the basic purpose of providing an intermediate support between the structural members of the rack. As a result, it becomes

Copyright NFPA

almost impossible to define and maintain transverse flue spaces across the rack as required.

A.17.3.1.1 In this application ordinary-, intermediate-, or high-temperature sprinklers can be used. There are no data to support temperature rating restrictions for this section.

A.17.3.3 ESFR sprinklers are designed to respond quickly to growing fires and deliver heavy discharge to suppress fires rather than to control them. ESFR sprinklers should not be relied on to provide suppression if they are used outside the design parameters.

While these sprinklers are intended primarily for use in high-pile storage situations, this section permits their use and extension into adjacent portions of an occupancy that might have a lesser classification.

Storage in single-story or multistory buildings can be permitted, provided the maximum ceiling/roof height as specified in Chapter 12 is satisfied for each storage area.

Design parameters were determined from a series of full-scale fire tests that were conducted as a joint effort between Factory Mutual Research Corporation and the National Fire Protection Research Foundation. (Copies of the test reports are available from the NFPRF.)

A.17.3.4.1.3 *Figure 17.3.4.1.3(a)* — The protection area per sprinkler under barriers should be no greater than 80 ft² (7.44 m²).

Figure 17.3.4.1.3(b) — The protection area per sprinkler under barriers should be no greater than 80 ft² (7.44 m²).

Figure 17.3.4.1.3(c) — The protection area per sprinkler under barriers should be no greater than 50 ft² (4.65 m²).

Figure 17.3.4.1.3(d) — The protection area per sprinkler under barriers should be no greater than 50 ft² (4.65 m²).

Figure 17.3.4.1.3(e) — The protection area per sprinkler under barriers should be no greater than 50 ft² (4.65 m²).

Figure 17.3.4.1.3(f) — The protection area per sprinkler under barriers should be no greater than 50 ft² (4.65 m²).

A.18.4 The protection criteria in Table 18.4(a) through Table 18.4(d) have been developed from fire test data. Protection requirements for other storage methods are beyond the scope of this standard at the present time. From fire testing with densities of 0.45 gpm/ft² (18.3 mm/min) and higher, there have been indications that large-orifice sprinklers at greater than 50 ft² (4.6 m²) spacing produce better results than the ½ in. (12.7 mm) orifice sprinklers at 50 ft² (4.6 m²) spacing.

Table 18.4(a) and Table 18.4(c) are based on operation of standard sprinklers. Use of quick-response or other special sprinklers should be based on appropriate tests as approved by the authority having jurisdiction.

The current changes to Table 18.4(a) through Table 18.4(d) represent test results from rubber tire fire tests performed at the Factory Mutual Research Center.

Storage heights and configurations, or both [e.g., automated material-handling systems

above 30 ft (9.1 m)], beyond those indicated in the table have not had sufficient test data developed to establish recommended criteria. Detailed engineering reviews of the protection should be conducted and approved by the authority having jurisdiction.

A.19.1 This section provides a summary of the data developed from the tissue test series of full-scale roll paper tests conducted at the Factory Mutual Research Center in West Glocester, RI.

The test building is approximately 200 ft × 250 ft [50,000 ft² (4.65 km²)] in area, of fire-resistive construction, and has a volume of approximately 2.25 million ft³ (63,720 m³), the equivalent of a 100,000 ft² (9.29 km²) building 22.5 ft (6.86 m) high. The test building has two primary heights beneath a single large ceiling. The east section is 30 ft (9.1 m) high and the west section is 60 ft (18.29 m) high.

The tissue test series was conducted in the 30 ft (9.1 m) section, with clearances from the top of storage to the ceiling nominally 10 ft (3.1 m).

Figure A.19.1 illustrates a typical storage array used in the tissue series of tests.

The basic criteria used in judging test failure included one or more of the following:

- (1) Firespread to the north end of the storage array
- (2) Gas temperatures near the ceiling maintained at high levels for a time judged to be sufficient to endanger exposed structural steel
- (3) Fire reaching the target stacks

Table A.19.1 outlines the tissue test results.

Fire tests have been conducted on 20 ft (6.1 m) and 25 ft (7.6 m) high vertical storage of tissue with 10 ft (3.1 m) and 5 ft (1.5 m) clear space to the ceiling in piles extending up to seven columns in one direction and six columns in the other direction. In these tests, target columns of tissue were located directly across an 8 ft (2.4 m) aisle from the main pile. Three tests were conducted using K-8.0 286°F (141°C) high-temperature sprinklers on a 100 ft² (9.3 m²) spacing and at constant pressures of 14 psi, 60 psi, and 95 psi (1 bar, 4.1 bar, and 6.6 bar), respectively. One test was run using 0.64 in. (16.3 mm) 286°F (141°C) high-temperature sprinklers on a 100 ft² (9.3 m²) spacing at a constant pressure of 50 psi (3.5 bar). Two tests were conducted following a scheduled decay from an initial pressure of 138 psi (9.5 bar) to a design point of 59 psi (4.1 bar) if 40 sprinklers opened. The significant characteristic of these fire tests was the rapid initial firespread across the surface of the rolls. Ceiling temperatures were controlled during the decaying pressure tests and during the higher constant pressure tests. With the exception of the 20 ft (6.1 m) high decaying pressure test, the extent of firespread within the pile could not be clearly established. Aisle jump was experienced, except at the 95 psi (6.6 bar) constant pressure, 20 ft (6.1 m) high decaying pressure, and large drop test. Water absorption and pile instability caused pile collapse in all tests. This characteristic should be considered where manually attacking a fire in tissue storage occupancies.

Available fire experience in roll tissue storage occupancies does not correlate well with the constant pressure full-scale fire tests with respect to the number of sprinklers operating and

the extent of firespread. Better correlation is noted with the decaying pressure tests. Thirteen fires reported in storage occupancies with storage piles ranging from 10 ft to 20 ft (3.1 m to 6.1 m) high and protected by wet pipe sprinkler systems ranging from ordinary hazard design densities to design densities of 0.6 gpm/ft² (24.5 mm/min) were controlled with an average of 17 sprinklers. The maximum number of wet pipe sprinklers that opened was 45, and the minimum number was 5, versus 88 and 26, respectively, in the constant pressure tests. Seventeen sprinklers opened in the 20 ft (6.1 m) high decaying pressure test. One actual fire in tissue storage provided with a dry pipe system opened 143 sprinklers but was reported as controlled.

One fire test was conducted with plastic-wrapped rolls of heavyweight kraft paper. The on-end storage was in a standard configuration, 20 ft (6.1 m) high with 9½ ft (2.9 m) clearance to ceiling sprinklers. The prescribed 0.3 gpm/ft² (12.2 mm/min) density controlled the firespread, but protection to roof steel was marginal to the point where light beams and joists might be expected to distort. A lower moisture content in the paper as a result of the protective plastic wrapping was considered to be the reason for the higher temperatures in this test as compared to a similar test where the rolls were not wrapped.

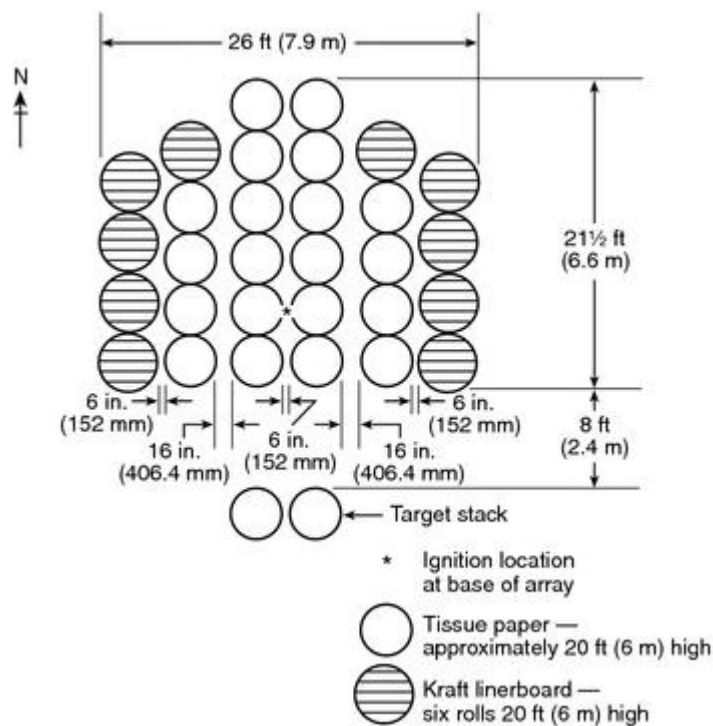

FIGURE A.19.1 Plan View of Typical Tissue Storage Array.

Table A.19.1 Summary of Roll Paper Tissue Tests

Test Specifications	Test Number			
	B1 ^a	B2	B3	B4
Test date	10/4/79	7/23/80	7/30/80	10/15/80
Paper type	Tissue	Tissue	Tissue	Tissue
Stack height [ft-in. (m)]	21-10 (6.66)	20-0 (6.1)	21-8 (21.60)	18-6 (6.64)
Paper, banded	No	No	No	No

Table A.19.1 Summary of Roll Paper Tissue Tests

Test Specifications	Test Number			
	B1 ^a	B2	B3	B4
Paper, wrapped	No	No	No	No
Fuel array	Standard	Standard	Standard	Standard
Clearance to ceiling [ft-in. (m)]	8–2 (2.49)	10–0 (3.05)	8–4 (2.54)	11–6 (3.51)
Clearance to sprinklers [ft-in. (m)]	7–7 (2.31)	9–5 (2.87)	7–9 (2.36)	10–9 (3.28)
Sprinkler orifice [in. (mm)]	$\frac{17}{32}$ (13.5)	$\frac{17}{32}$ (13.5)	$\frac{17}{32}$ (13.5)	0.64 (16.33)
Sprinkler temperature rating [F (°C)]	280 (138)	280 (138)	280 (138)	280 (138)
Sprinkler spacing [ft × ft (m × m)]	10 × 10 (3.05 × 3.05)	10 × 10 (3.05 × 3.05)	10 × 10 (3.05 × 3.05)	10 × 10 (3.05 × 3.05)
Water pressure [psi (bar)]	14 (0.9) ^c	60 (4.1)	95 (6.6)	50 (3.4)
Moisture content of paper (%)	9.3	9.3	10.2	6.0
First sprinkler operation (min:sec)	0:43	0:32	0:38	0:31
Total sprinklers open	88	33	26	64
Final flow [gpm (L/min)]	2575 (9746) ^c	1992 (7540)	1993 (7544)	4907 (18,573)
Sprinkler demand area [ft ² (m ²)]	8800 (817.5)	3300 (306.6)	2600 (241.5)	6400 (595)
Average discharge density [gpm/ft ² (mm/min)]	0.29 (11.8) ^c	0.60 (24.4)	0.77 (31.4)	—
Maximum 1-minute average gas temperature over ignition [°F (°C)]	1680 (916) ^c	1463 (795)	1634 (890)	1519 (826)
Duration of high temperature within acceptable limits	No	Yes	Yes	Marginal
Maximum 1-minute average fire plume gas velocity over ignition [ft/sec (m/sec)]	—	40.7 (12.4)	50.2 (15.3)	47.8 (14.6)
Target ignited	Yes	Yes	No	No
Extent of fire damage within acceptable limits	No	No	Marginal	Marginal
Test duration (min)	17.4	20	20	25.5

^a Phase I test.

^b Phase III tests decaying pressure.

^c Pressure increased to 50 psi (3.5 bar) at 10 minutes.

^d Maximum steel temperature over ignition 341°F (172°C).

^e Maximum steel temperature over ignition 132°F (56°C).

A.19.1.2 Existing Systems. Sprinkler systems protecting existing roll paper storage facilities should be evaluated in accordance with Table A.19.1.2(a) and Table A.19.1.2(b). While fire can be controlled by the protection shown in Table A.19.1.2(a) and Table A.19.1.2(b), greater damage can occur when the densities in Table A.19.1.2(a) and Table A.19.1.2(b) are used rather than those specified in Table 19.1.2.1.3(a) and Table 19.1.2.1.3(b).

Table A.19.1.2(a) Automatic Sprinkler System Design Criteria — Spray Sprinklers for 1 are gpm/ft² over ft².)

	Heavyweight
--	--------------------

should be evaluated in accordance with Table A.19.1.2(a) and Table A.19.1.2(b). While fire can be controlled by the protection shown in Table A.19.1.2(a) and Table A.19.1.2(b), greater damage can occur when the densities in Table A.19.1.2(a) and Table A.19.1.2(b) are used rather than those specified in Table 19.1.2.1.3(a) and Table 19.1.2.1.3(b).

Table A.19.1.2(a) Automatic Sprinkler System Design Criteria — Spray Sprinklers for 1 are gpm/ft² over ft².)

Storage Height (ft)	Clearance (ft)	Heavyweight					Closed Array Banded or Unbanded
		Closed Array Banded or Unbanded	Standard Array		Open Array		
			Banded	Unbanded	Banded	Unbanded	
10	≤5	0.2/2000	0.2/2000	0.2/2000	0.25/2000	0.25/2000	0.2/2000
10	>5	0.2/2000	0.2/2000	0.2/2000	0.25/2500	0.25/2500	0.2/2000
15	≤5	0.25/2000	0.25/2000	0.25/2500	0.3/2500	0.3/3000	0.25/2000
15	>5	0.25/2000	0.25/2000	0.25/2500	0.3/3000	0.3/3500	0.25/2000
20	≤5	0.3/2000	0.3/2000	0.3/2500	0.45/3000	0.45/3500	0.3/2000
20	>5	0.3/2000	0.3/2500	0.3/3000	0.45/3500	0.45/4000	0.3/2500
25	≤5	0.45/2500	0.45/3000	0.45/3500	0.6/2500	0.6/3000	0.45/3000
25	>5	0.45/3000	0.45/3500	0.45/4000	0.6/3000	0.6/3500	0.45/3500
30	≤5	0.6/2500	0.6/3000	0.6/3000	0.75/2500	0.75/3000	0.6/4000

Note: Densities or areas, or both, can be interpolated between any 5 ft storage height increment.

Table A.19.1.2(b) Automatic Sprinkler System Design Criteria — Spray Sprinklers for are mm/min over m².)

Storage Height (m)	Clearance (m)	Heavyweight					Clos Ba Un
		Closed Array Banded or Unbanded	Standard Array		Open Array		
			Banded	Unbanded	Banded	Unbanded	
3.1	≤1.5	0.76/185.8	0.76/185.8	0.76/185.8	0.95/185.8	0.95/185.8	0.7
3.1	>1.5	0.76/185.8	0.76/185.8	0.76/185.8	0.95/232.3	0.95/232.3	0.7
4.6	≤1.5	0.95/185.8	0.95/185.8	0.95/232.3	12.2/232.3	12.2/278.7	0.9
4.6	>1.5	0.95/185.8	0.95/185.8	0.95/232.3	12.2/278.7	12.2/325.2	0.9
6.1	≤1.5	12.2/185.8	12.2/185.8	12.2/232.3	18.3/278.7	18.3/325.2	12.
6.1	>1.5	12.2/185.8	12.2/232.3	12.2/278.7	18.3/325.2	18.3/371.6	12.
7.6	≤1.5	18.3/232.3	18.3/278.7	18.3/325.2	24.5/232.3	24.5/278.7	18.
7.6	>1.5	18.3/278.7	18.3/325.2	18.3/371.6	24.5/278.7	24.5/325.2	18.
9.1	≤1.5	24.5/232.3	24.5/278.7	24.5/278.7	30.6/232.3	30.6/278.7	24.

Note: Densities or areas, or both, can be interpolated between any 1.5 m storage height increment.

A.19.1.2.1.4 Generally, more sprinklers open in fires involving roll paper storage protected

by sprinklers rated below the high-temperature range. An increase of 67 percent in the design area should be considered.

A.20.2 Exposed, expanded plastic dunnage, instrument panels, and plastic bumper facia were the automotive components with their related packaging that were utilized in the fire tests. This test commodity used in the large-scale sprinklered fire test proved to be the worst challenge per the large-scale calorimeter tests of available components. See *Technical Report of Fire Testing of Automotive Parts in Portable Storage Racking*, prepared by Underwriters Laboratories, Project 99NK29106, NC4004, January 5, 2001, and *Commodity Hazard Comparison of Expanded Plastic in Portable Bins and Racking*, Project 99NK29106, NC4004, September 8, 2000.

A.20.3 These special designs are based on fire heat release calorimeter tests and 10 full-scale tests conducted by the Retail Fire Research Coalition at Underwriters Laboratories in 2000. [See *Figure A.20.3(a) through Figure A.20.3(f)*.]

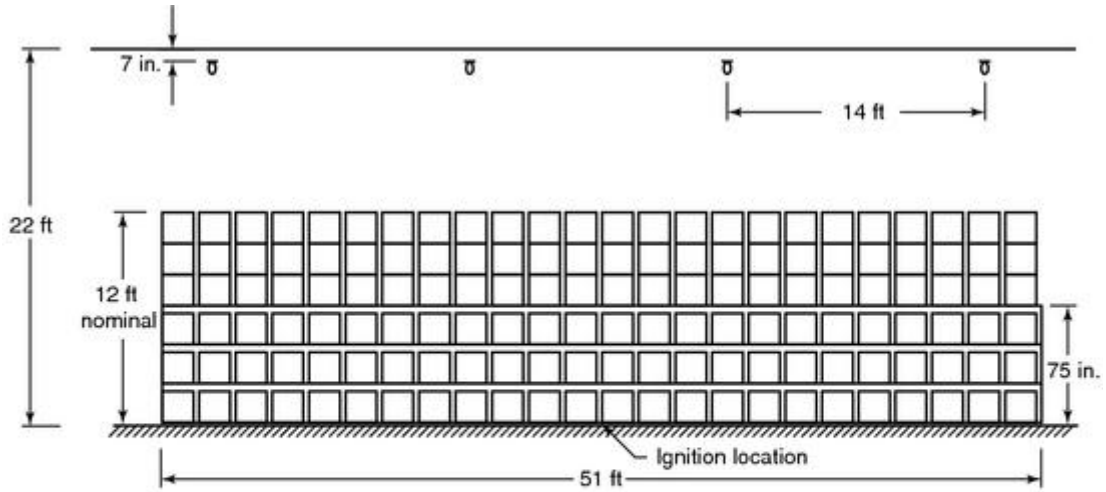

Legend:

- ⊕ K-25.2 165°F upright style sprinkler
- Group A plastic test commodity

**Fire Test A1
Side Elevation View of Main Array**

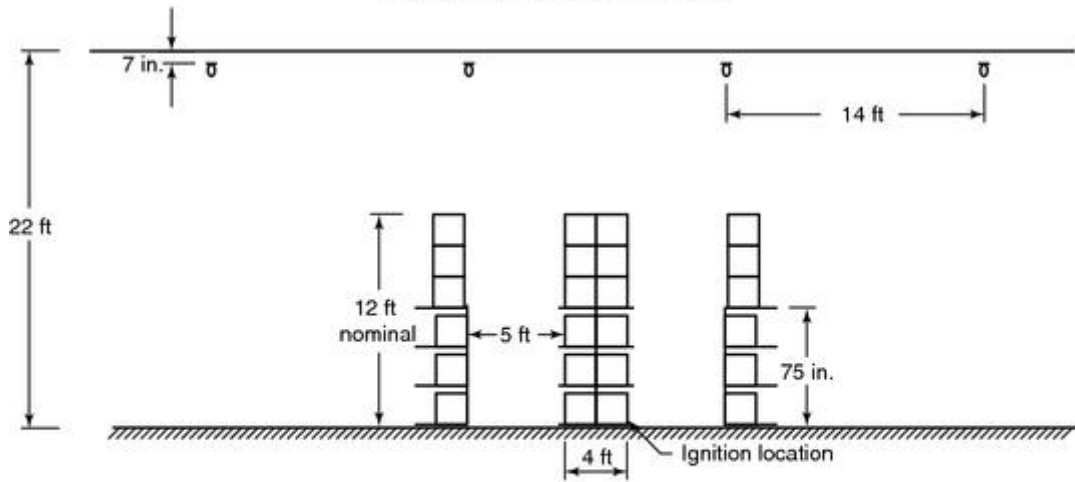

Legend:

- ⊕ K-25.2 165°F upright style sprinkler
- Group A plastic test commodity

**Fire Test A1
Front Elevation View**

FIGURE A.20.3(a) Fire Test A1.

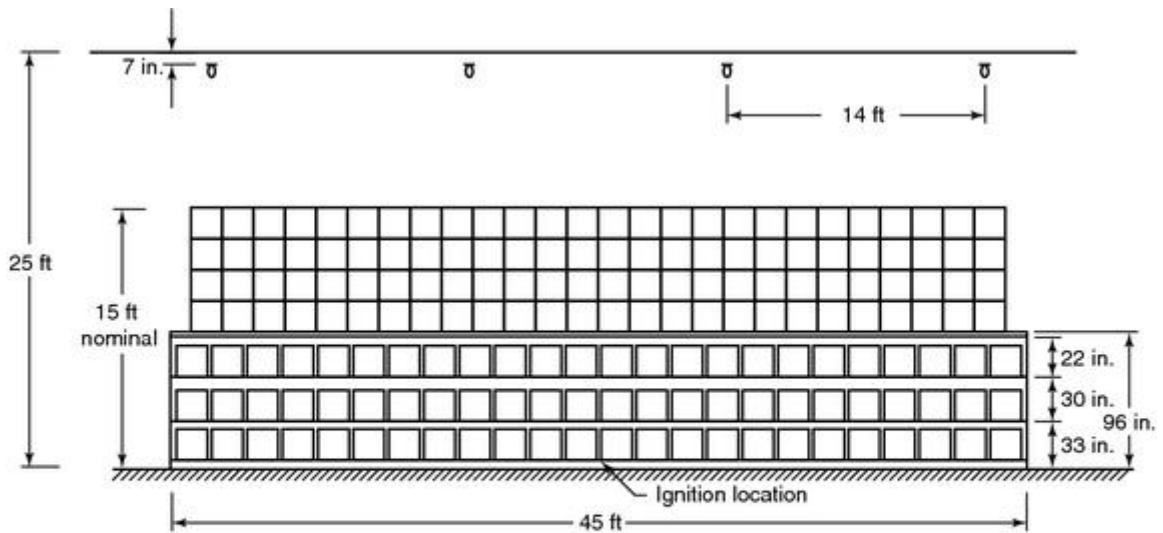

Legend:

- ⊙ K-25.2 165°F upright style sprinkler
- Group A plastic test commodity

**Fire Test A2
Side Elevation View of Main Array**

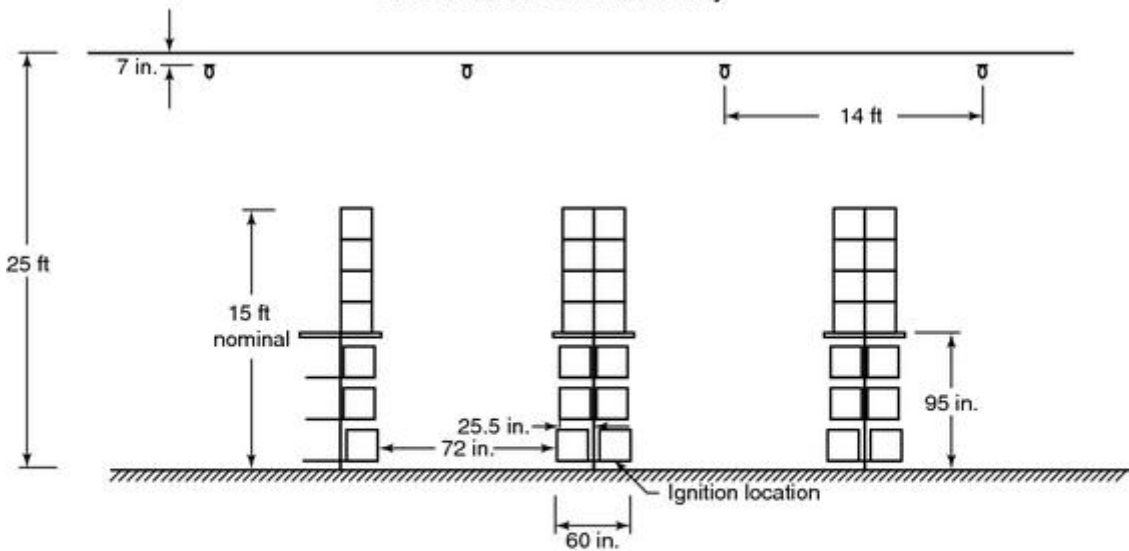

Legend:

- ⊙ K-25.2 165°F upright style sprinkler
- Group A plastic test commodity

**Fire Test A2
Front Elevation View**

FIGURE A.20.3(b) Fire Test A2.

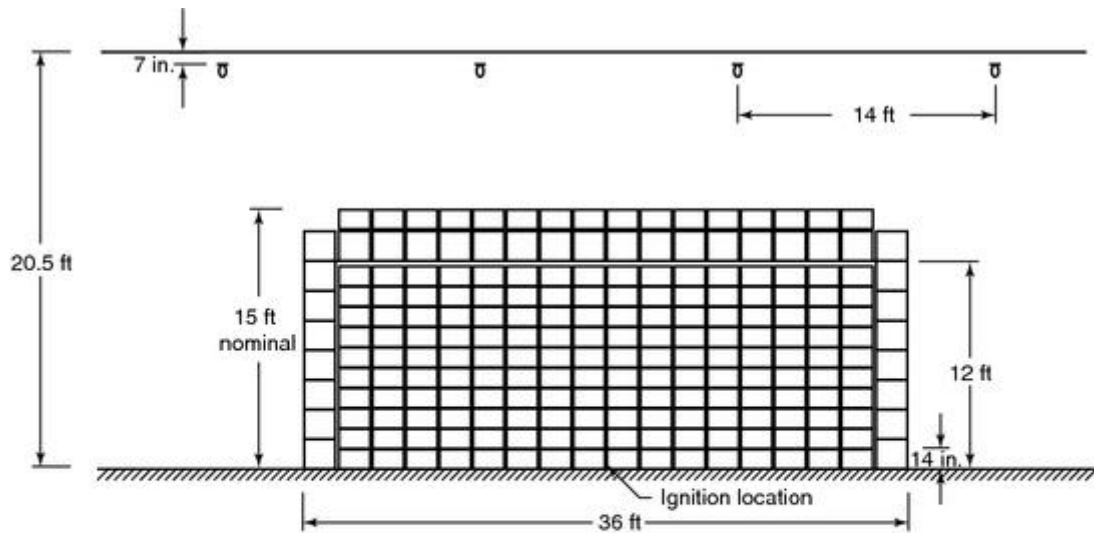

Legend:

- ⊠ K-25.2 165°F upright style sprinkler
- Group A plastic test commodity nominal 12.25 in. tall
- Group A plastic test commodity nominal 21 in. tall

Fire Test A3
Side Elevation View of Main Array

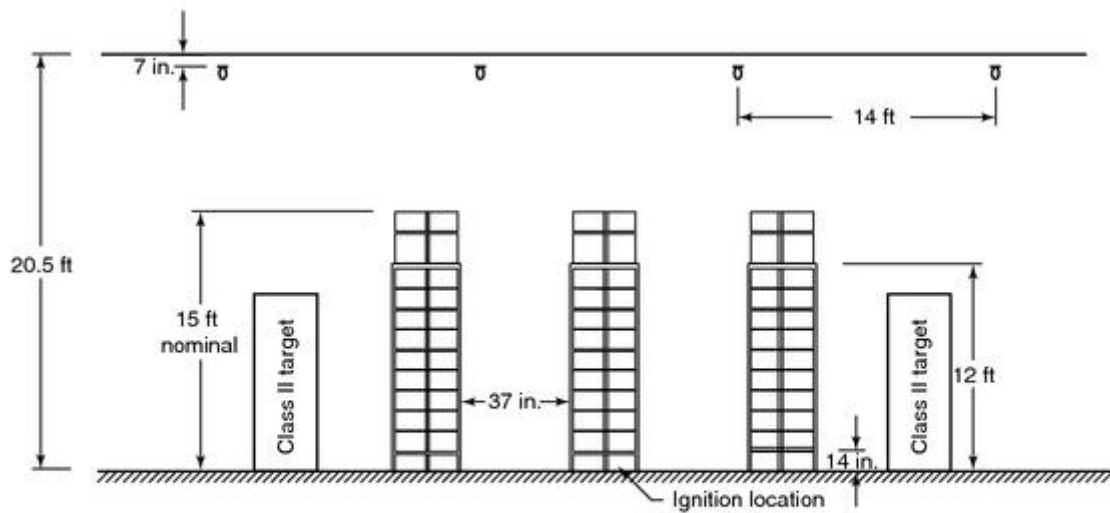

Legend:

- ⊠ K-25 165°F QR upright style sprinkler
- Group A plastic test commodity nominal 12.25 in. tall
- Group A plastic test commodity nominal 21 in. tall

Fire Test A3
Front Elevation View

FIGURE A.20.3(c) Fire Test A3.

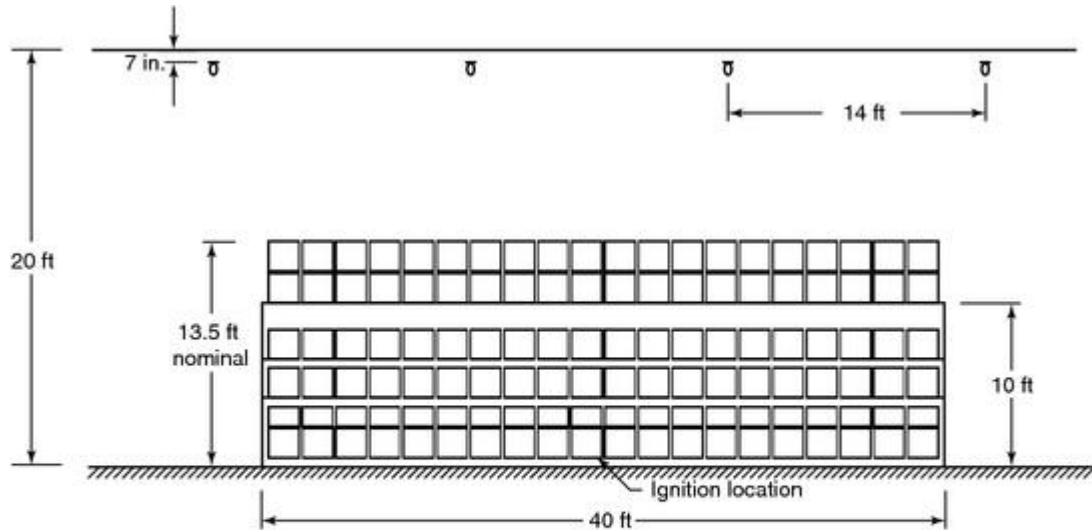

Legend:

- Ω K-25.2 165°F upright style sprinkler
- Group A plastic test commodity nominal 12.25 in. tall
- Group A plastic test commodity nominal 21 in. tall

Fire Test A4
Side Elevation View of Main Array

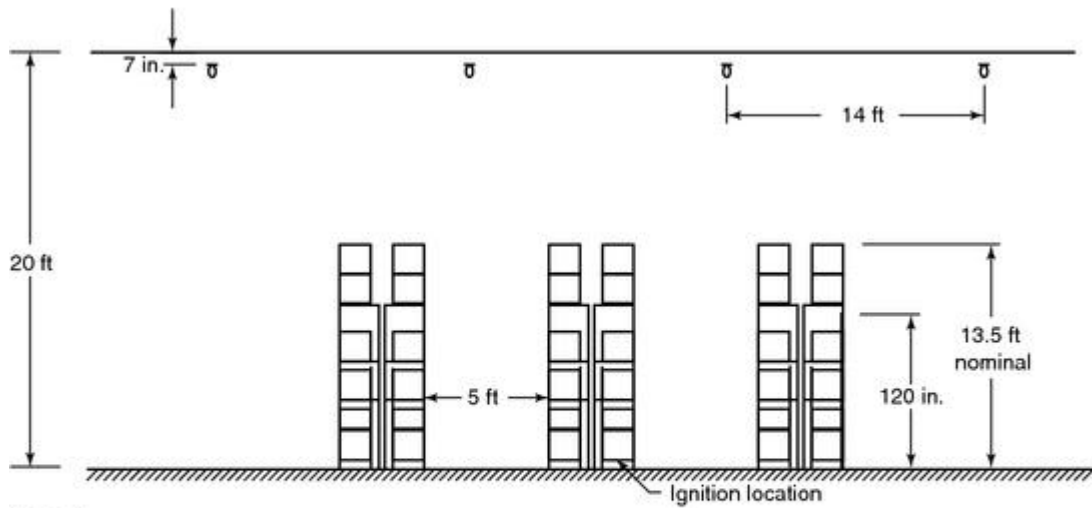

Legend:

- Ω K-25.2 165°F upright style sprinkler
- Group A plastic test commodity nominal 12.25 in. tall
- Group A plastic test commodity nominal 21 in. tall

Fire Test A4
Front Elevation View

FIGURE A.20.3(d) Fire Test A4.

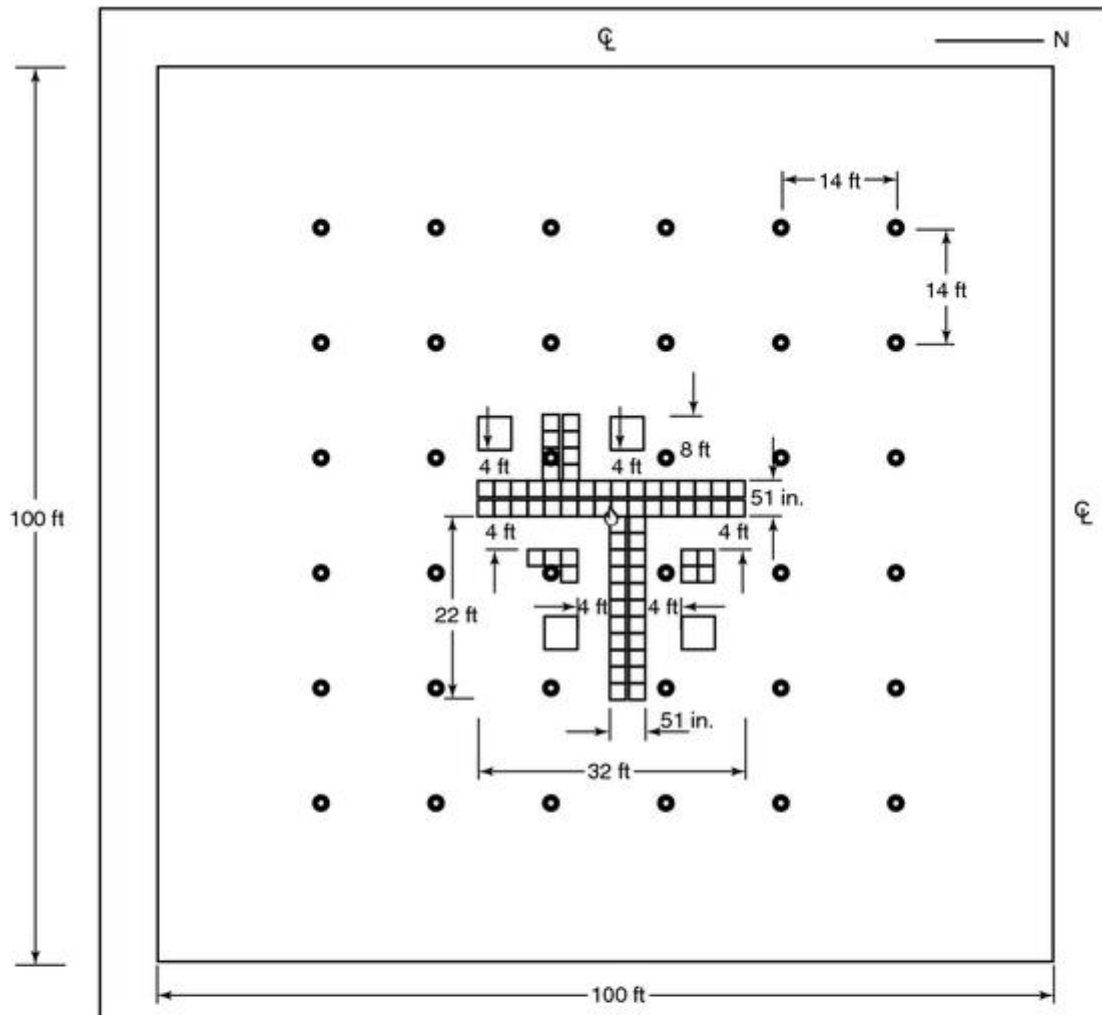

Shelving suspended on wire uprights at 24 in., 48 in., 72 in., 96 in., and 120 in. with a wire shelf at 148 in.

Legend:

- K-25 upright style sprinkler 165°F QR, 0.55 gpm/ft² water density for first four sprinkler operations, then 0.49 gpm/ft² for all additional operations
- Group A plastic test commodity
- Class II target commodity
- 🔥 Ignition location

Fire Test A6
Plan View

FIGURE A.20.3(e) Fire Test A6 — Plan View.

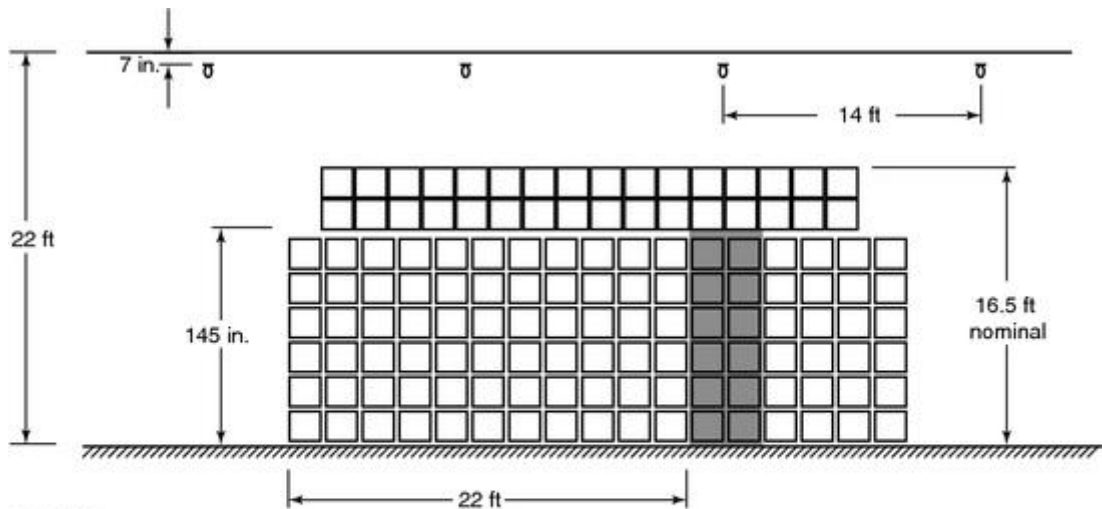

Legend:

- ◻ K-25.2 165°F upright style sprinkler
- ◻ Group A plastic test commodity

Fire Test A6
North Side Elevation View of Main Array

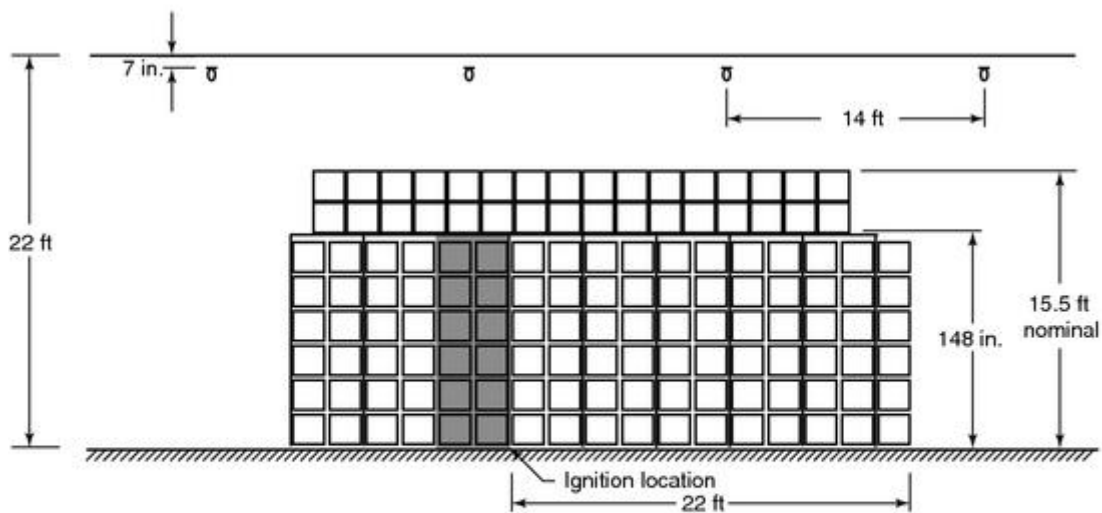

Legend:

- ◻ K-25.2 165°F upright style sprinkler
- ◻ Group A plastic test commodity

Fire Test A6
South Side Elevation View of Main Array

FIGURE A.20.3(f) Fire Test A6 — Main Array (North/South).

A.21.4.1.1 Spray application operations should be located only in buildings that are completely protected by an approved system of automatic sprinklers. If located in unsprinklered buildings, sprinklers should be installed to protect spray application processes where practical. Because of the rapidity and intensity of fires that involve spray operations, the available water should be ample to simultaneously supply all sprinkler heads likely to open in one fire without depleting the available water for use by hose streams. Noncombustible draft curtains can be used to limit the number of sprinklers that will open.

Even when areas adjacent to coating operations are considered under reasonably positive fire control by adequate automatic sprinkler protection, damage is possible if operations are conducted on floors above those containing contents that are highly susceptible to water damage. Waterproofing and drainage of spray room floors can assist in reducing water damage on floors below. The proper drainage of the large volume of water frequently necessary to extinguish spray finishing room fires often presents considerable difficulty. [33: A.9.4]

A.21.4.2.1 Automatic sprinklers in spray areas, including the interior of spray booths and exhaust ducts, should be wet pipe, preaction, or deluge system so that water can be placed on the fire in the shortest possible time. Automatic sprinklers in spray booths and exhaust ducts should be of the lowest practical temperature rating. The delay in application of water with ordinary dry pipe sprinklers can permit a fire to spread so rapidly that final extinguishment is difficult without large resulting damage.

The location of the sprinkler heads inside spray booths should be selected with care in order to avoid heads being placed in the direct path of spray and yet afford protection for the entire booth interior. When sprinkler heads are in the direct path of spray, even one day's operation can result in deposits on the sprinkler heads that insulate the fusible link or choke open head orifices to the extent that sprinklers cannot operate efficiently.

Automatic sprinklers should also be located so that areas subject to substantial accumulations of overspray residue are protected. Generally, sprinklers are located no more than 4 ft (1.2 m) from side walls of booths and rooms and from dry overspray collectors (where applicable). Sprinklers in booths or rooms should be on extra hazard occupancy spacing of 90 ft² (8.4 m²).

All sprinklers in spray areas should be controlled by an accessible control valve, preferably an OS&Y valve. [33: A.9.4]

A.21.5.1 Water spray or deluge systems that are used to protect solvent extraction process equipment or structures should be designed to provide a density of not less than 0.25 gpm/ft² (10.3 mm/min) of protected surface area. (See NFPA 13 and NFPA 15, *Standard for Water Spray Fixed Systems for Fire Protection*, for additional information.) Foam-water sprinkler or deluge systems that are used for the same purposes should be designed to provide a density of not less than 0.16 gpm/ft² (6.5 mm/min) of protected surface area. (See NFPA 13 and NFPA 16, *Standard for the Installation of Foam-Water Sprinkler and Foam-Water Spray Systems*, for additional information.)

Preparation buildings should be protected with automatic sprinkler systems designed for ordinary hazard (Group 2), in accordance with NFPA 13. [36: A.4.8]

A.21.6.1 Automatic sprinkler systems are considered to be effective in controlling lubricating oil fires. Sprinkler densities provided in this standard are based on extra hazard, Group 1 occupancy as defined in NFPA 13. Automatic sprinkler protection designed as local protection for the engine in many cases provides better protection than sprinkler protection installed only at the ceiling level.

Consideration should be given to providing local protection when the protected engine

equipment is located in a high bay area. Delayed activation time or lack of water penetration could delay fire suppression from a ceiling system.

Local protection for engines can be accomplished using either a wet system or a single interlock pre-action system with heat detection. The system piping should loop the diesel at the height of the engine cylinder heads. Detectors should be located above the engine and around the system piping.

Because of the tight radial clearances on combustion gas turbines and the potential for rubbing of rotating parts and increased damage, it is advisable to use great care if using a sprinkler or water spray suppression system. Water from a ceiling or spot protection system could effectively control a fire; however, gaseous suppression agents could be just as effective without the potential for equipment damage when the system activates. [37: A.11.4.5.1]

A.21.7.2.3 See Figure A.21.7.2.3. The illustration shows the location of sprinkler heads and the decomposition vent. [40: A.63]

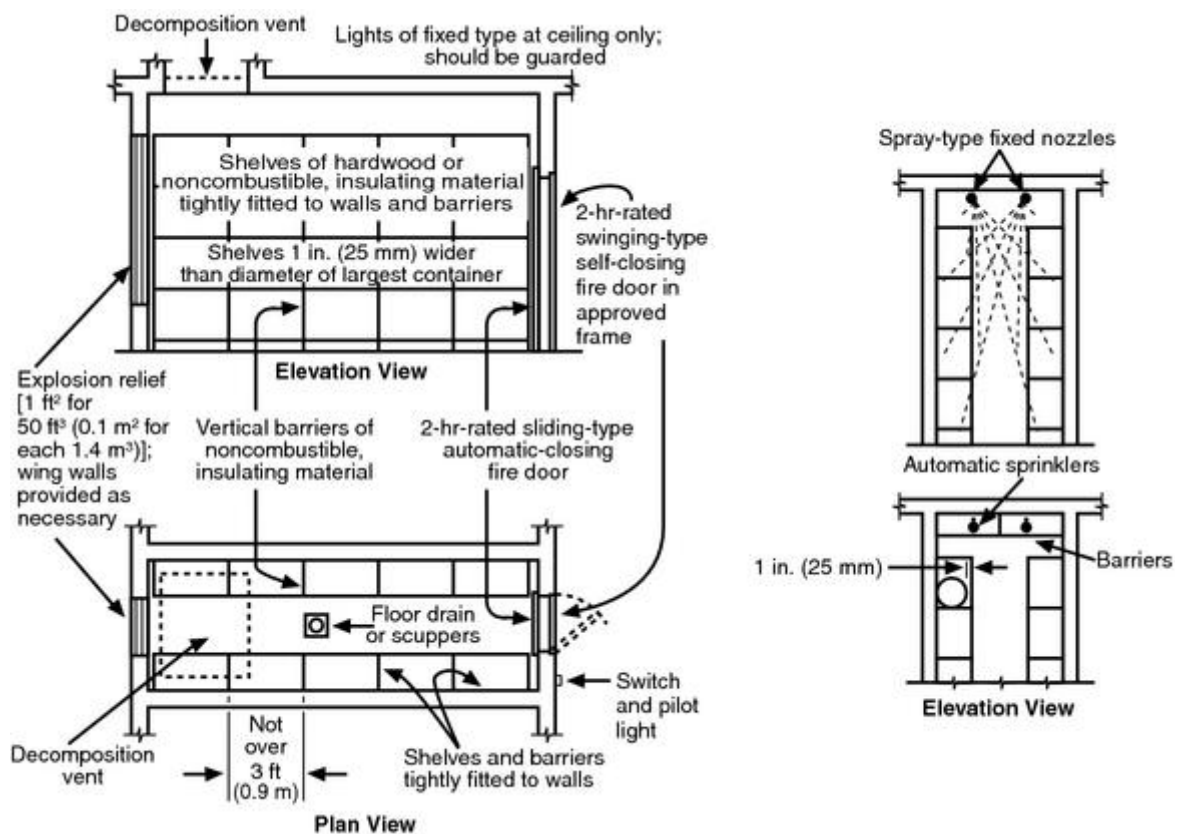

FIGURE A.21.7.2.3 Standard Film Vault (for Other Than Extended Term Storage Film). [40:Figure A.6.3]

A.21.7.2.3.3 The arrangement of sprinklers or nozzles for providing distribution over the face of shelving is important and requires knowledge of sprinkler discharge patterns and locations. This arrangement should be done only by qualified personnel. [40:6.3.7.3]

A.21.16.2.1 See Figure A.21.16.2.1(a) through Figure A.21.16.2.1(h).

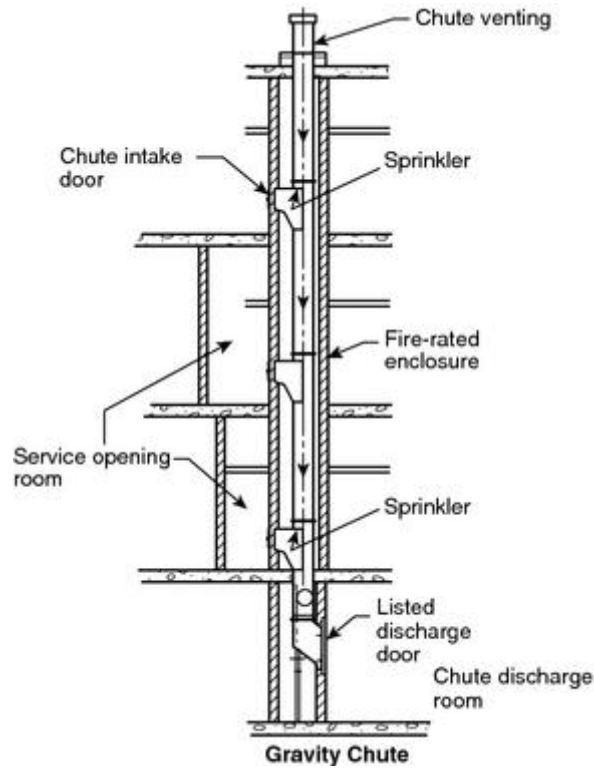

FIGURE A.21.16.2.1(a) Gravity Linen Chute. [82:Figure A.5.2(a)]

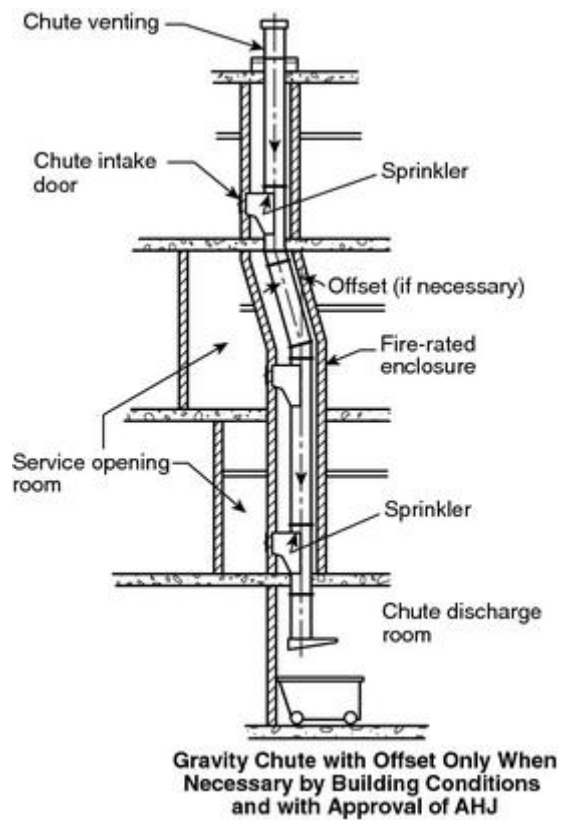

FIGURE A.21.16.2.1(b) Gravity Waste Chute. [82:Figure A.5.2(b)]

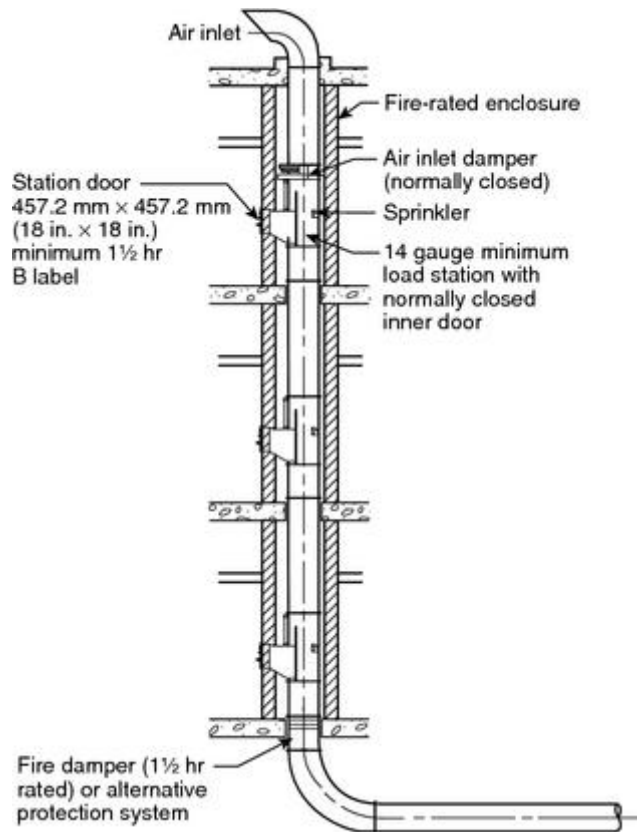

FIGURE A.21.16.2.1(c) Full Pneumatic System. [82:Figure A.5.3(a)]

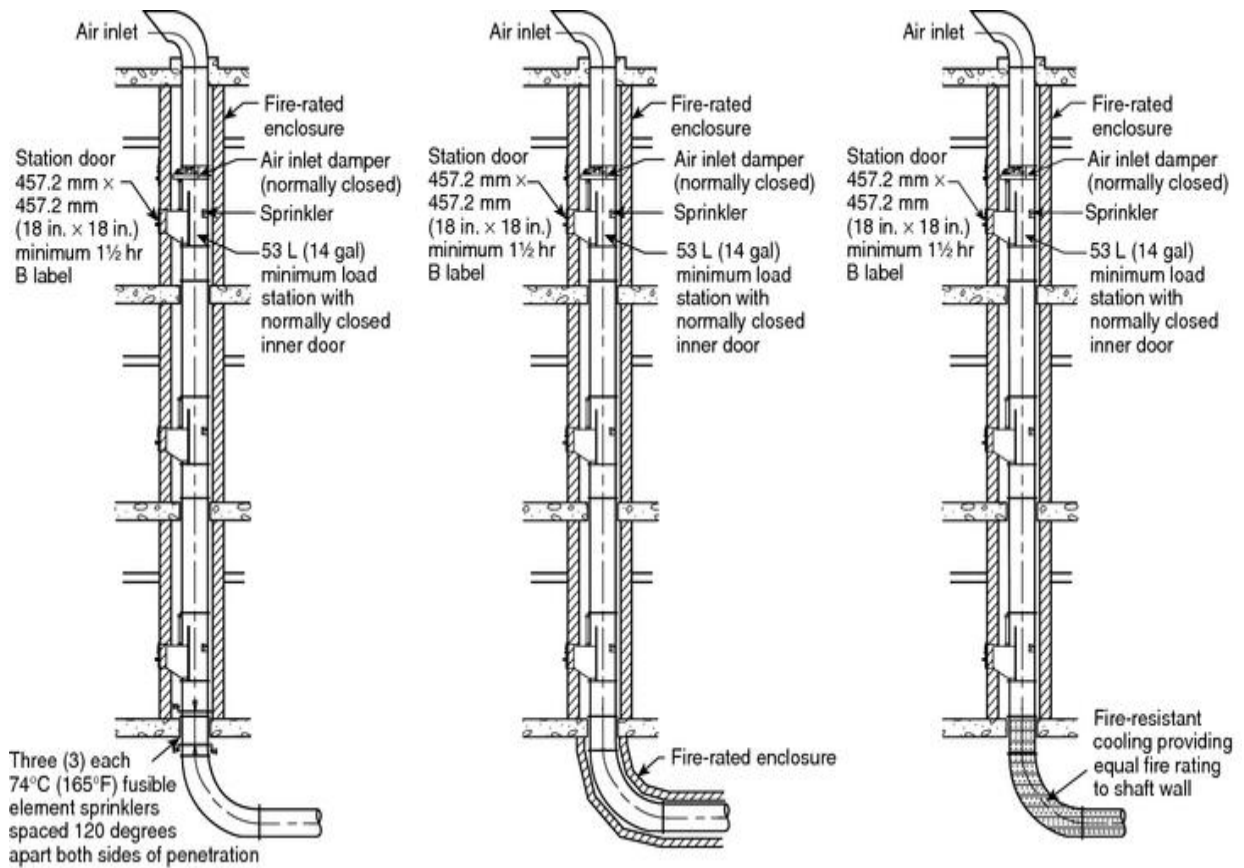

FIGURE A.21.16.2.1(d) Fire Damper Engineering Alternative for Penetration of Floor at Base of Shaft. [82:Figure A.5.3(b)]

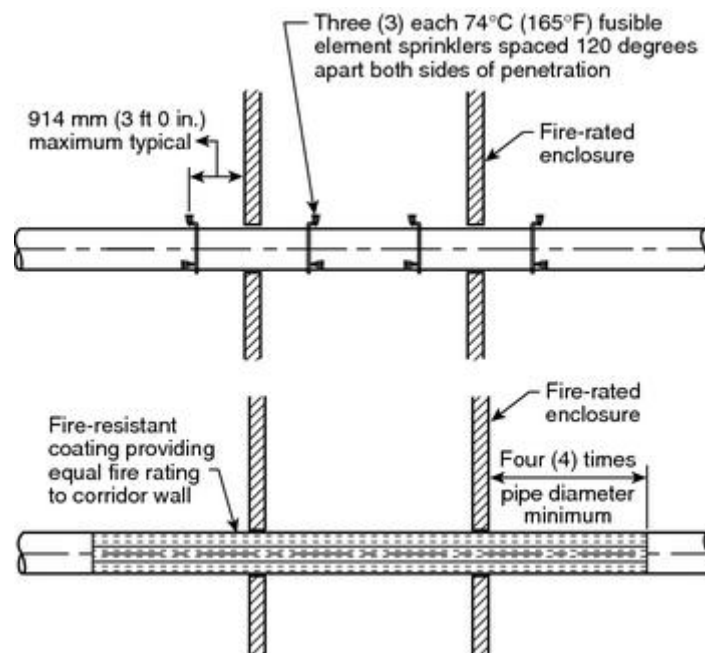

FIGURE A.21.16.2.1(e) Fire Damper Engineering Alternative for Penetration of Fire-Rated Enclosure. [82:Figure A.5.3(c)]

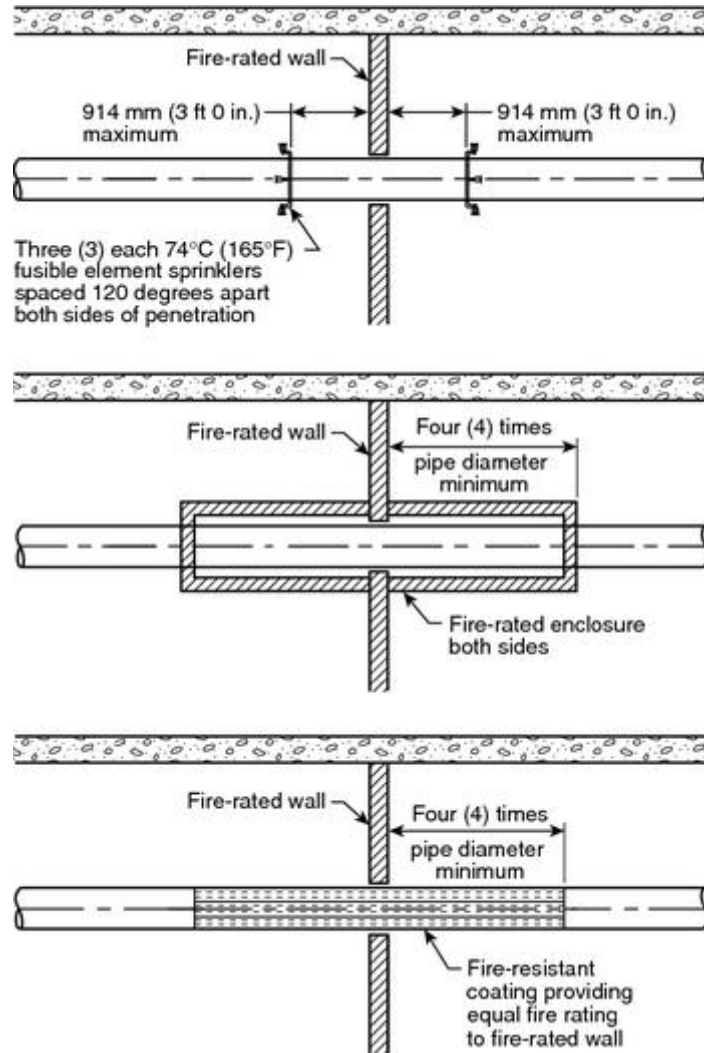

FIGURE A.21.16.2.1(f) Fire Damper Engineering Alternative for Penetration of Fire-Rated Wall. [82:Figure A.5.3(d)]

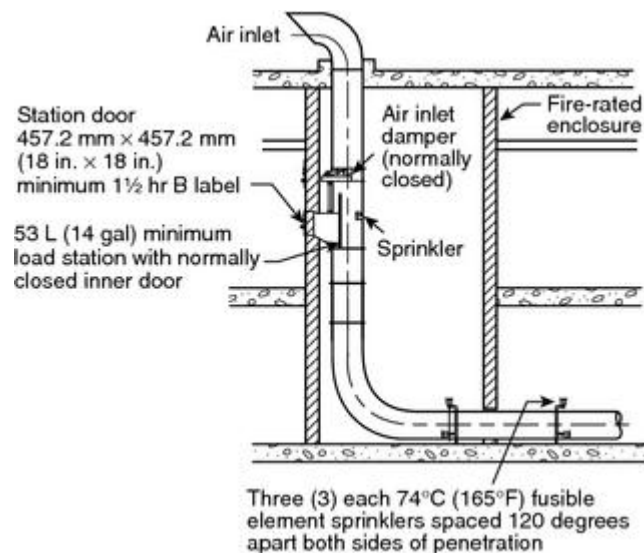

FIGURE A.21.16.2.1(g) Fire Damper Engineering Alternative for Penetration of Wall at Base of Shaft. [82:Figure A.5.3(e)]

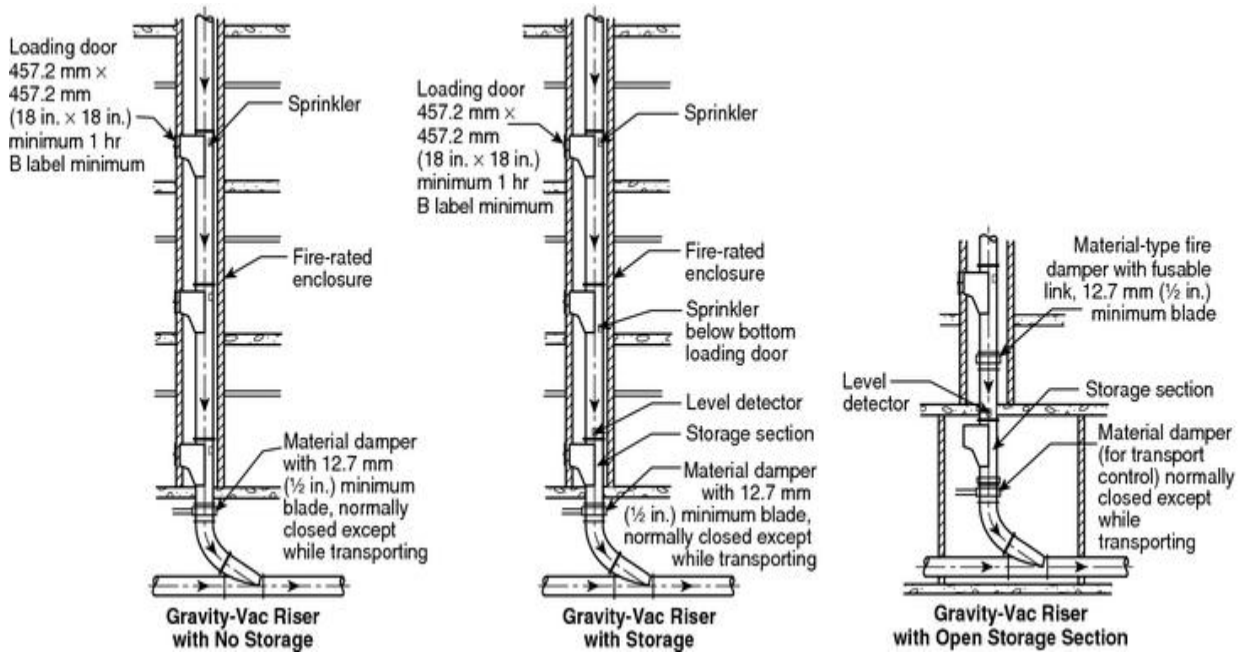

FIGURE A.21.16.2.1(h) Gravity Pneumatic System. [82:Figure A.5.4]

A.21.19.1.4 More than one control station could be required in a compartment (lock), depending on its size. [99: A.20.2.5.2.4]

A.21.19.1.7 Experience has shown that when water is discharged through conventional sprinkler heads into a hyperbaric atmosphere, the spray angle is reduced because of increased resistance to water droplet movement in the denser atmosphere. This is so even though the water pressure differential is maintained above chamber pressure. Therefore, it is necessary to compensate by increasing the number of sprinkler heads. It is recommended that spray coverage tests be conducted at maximum chamber pressure.

Some chamber configurations, such as small-diameter horizontal cylinders, might have a very tiny “floor,” or even no floor at all. For horizontal cylinder chambers and spherical chambers, “floor level” is taken to mean the level at $\frac{1}{4}$ diameter below the chamber centerline or actual “floor level,” whichever gives the larger floor area. [99: A.20.2.5.2.6]

A.21.24.1.1.1 A deluge system provides a higher degree of protection where water supplies are adequate. In climates that are subject to freezing temperatures, a deluge system minimizes the possibility of failure due to pipes freezing. [214: A.5.2.2.1]

A.21.24.1.1.2 The crossflow design is such that it is difficult to locate sprinklers in the most desirable spots for both water distribution and heat detection. This situation can be solved by separating these two functions and using separate water discharge and detection systems. [214: A.5.2.2.2]

A.21.24.1.7.1.1 Where a single deluge system protects an entire water-cooling tower, regardless of the number of cells, the water supply needs to be based on the entire deluge

system coverage. (See Figure A.21.24.1.7.1.1.) [214: A.5.6.1.1]

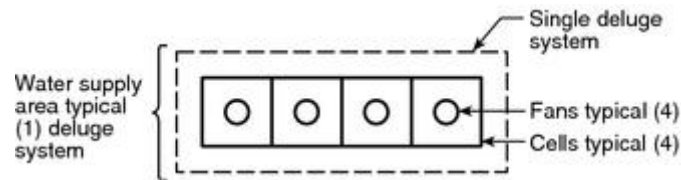

FIGURE A.21.24.1.7.1.1 Single Deluge System. [214:Figure A.5.6.1.1]

A.21.24.1.7.1.3 Deluge systems separated by fire-resistant partitions can be treated independently as worst-case water supply situations. (See Figure A.21.24.1.7.1.3.) [214: A.5.6.1.3]

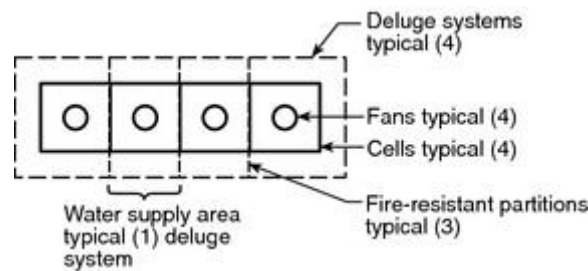

FIGURE A.21.24.1.7.1.3 Multiple Deluge Systems. [214:Figure A.5.6.1.3]

A.21.24.1.7.2.1 Water-cooling towers with each cell separated by a fire-resistant partition and protected by wet, dry, or preaction system(s) should have the water supply based on the most demanding individual cell. (See Figure A.21.24.1.7.2.1.) [214: A.5.6.2.1]

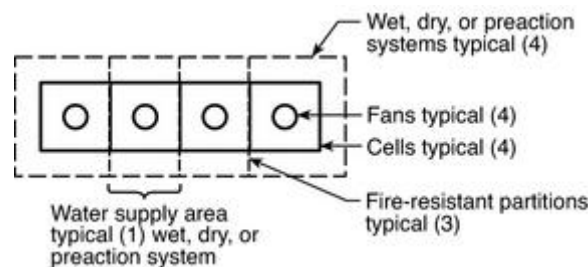

FIGURE A.21.24.1.7.2.1 Multiple Wet, Dry, or Preaction Systems with Fire-Resistant Partitions. [214:Figure A.5.6.2.1]

A.21.24.1.7.2.2 Without fire-resistant partitions between cells, the worst-case situation involves the most demanding adjoining cells. (See Figure A.21.24.1.7.2.2.) [214: A.5.6.2.2]

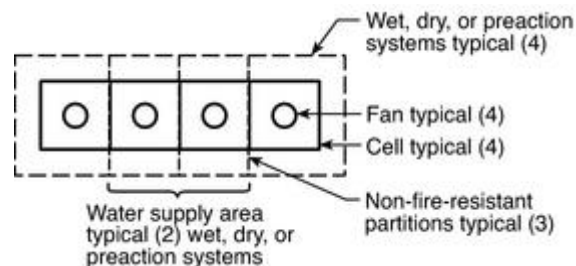

FIGURE A.21.24.1.7.2.2 Multiple Wet, Dry, or Preaction Systems with No Fire-Resistant Partitions. [214:Figure A.5.6.2.2]

A.21.24.2.1 See Figure A.21.24.2.1(a) through Figure A.21.24.2.1(d).

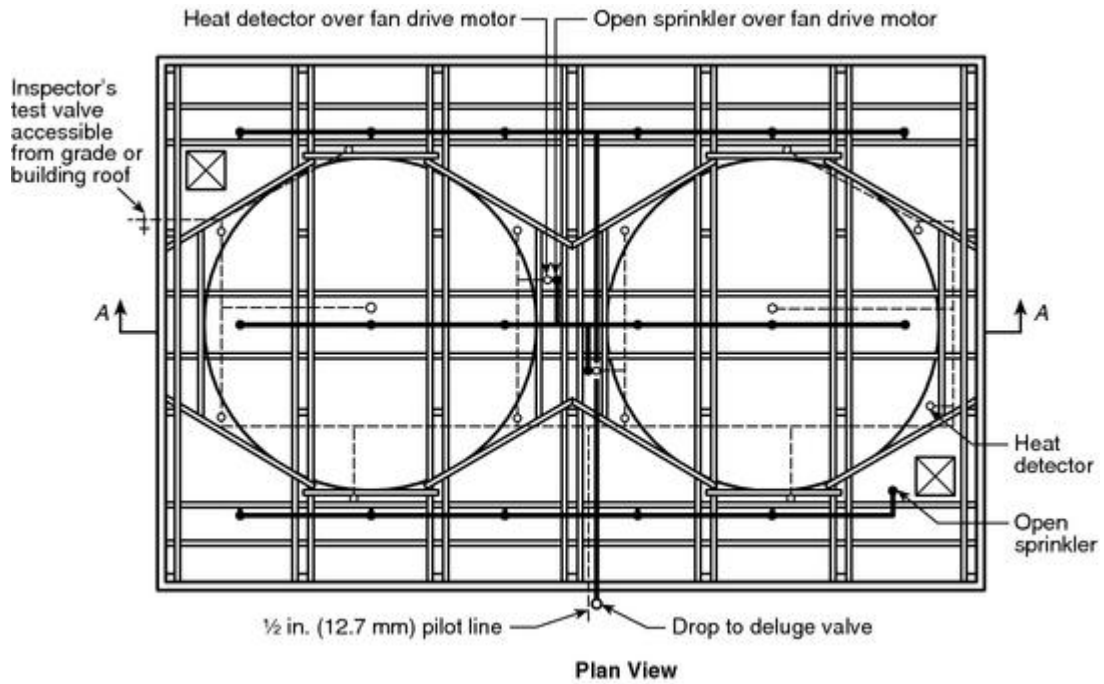

FIGURE A.21.24.2.1(a) Plan View, Typical Deluge Fire Protection Arrangement for Counterflow Towers. [214:Figure A.5.2.4.1(a)]

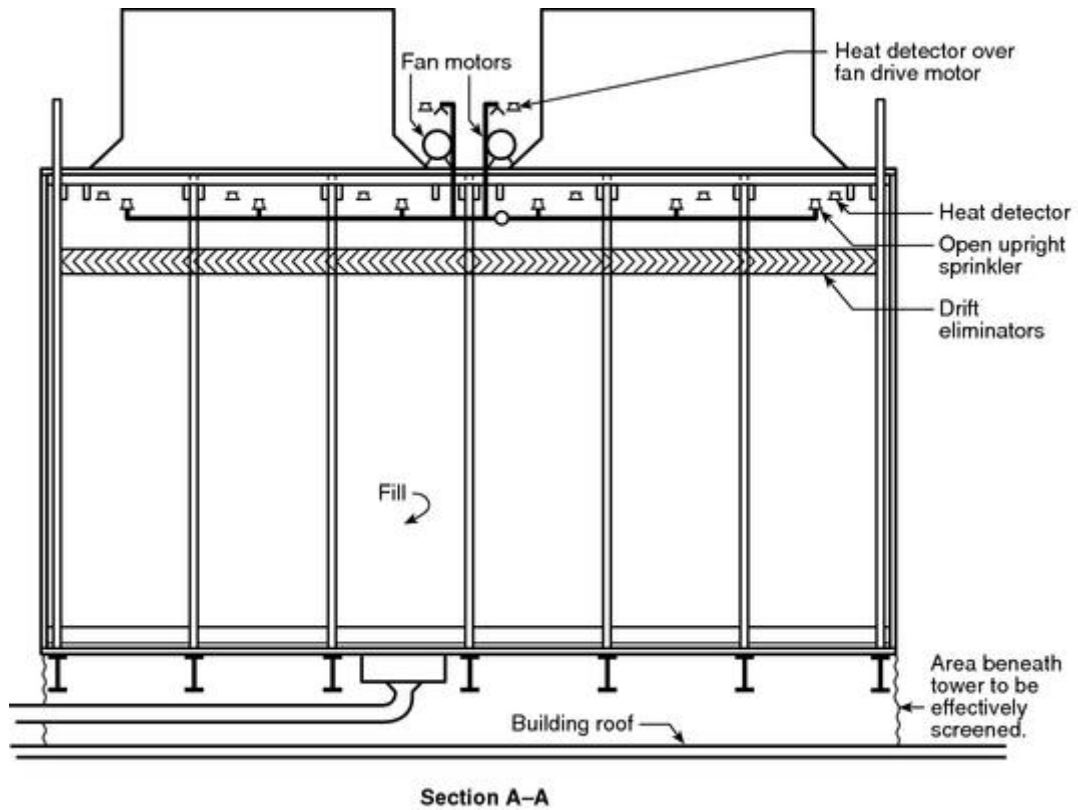

FIGURE A.21.24.2.1(b) Section View, Typical Deluge Fire Protection Arrangement for Counterflow Towers. [214:Figure A.5.2.4.1(b)]

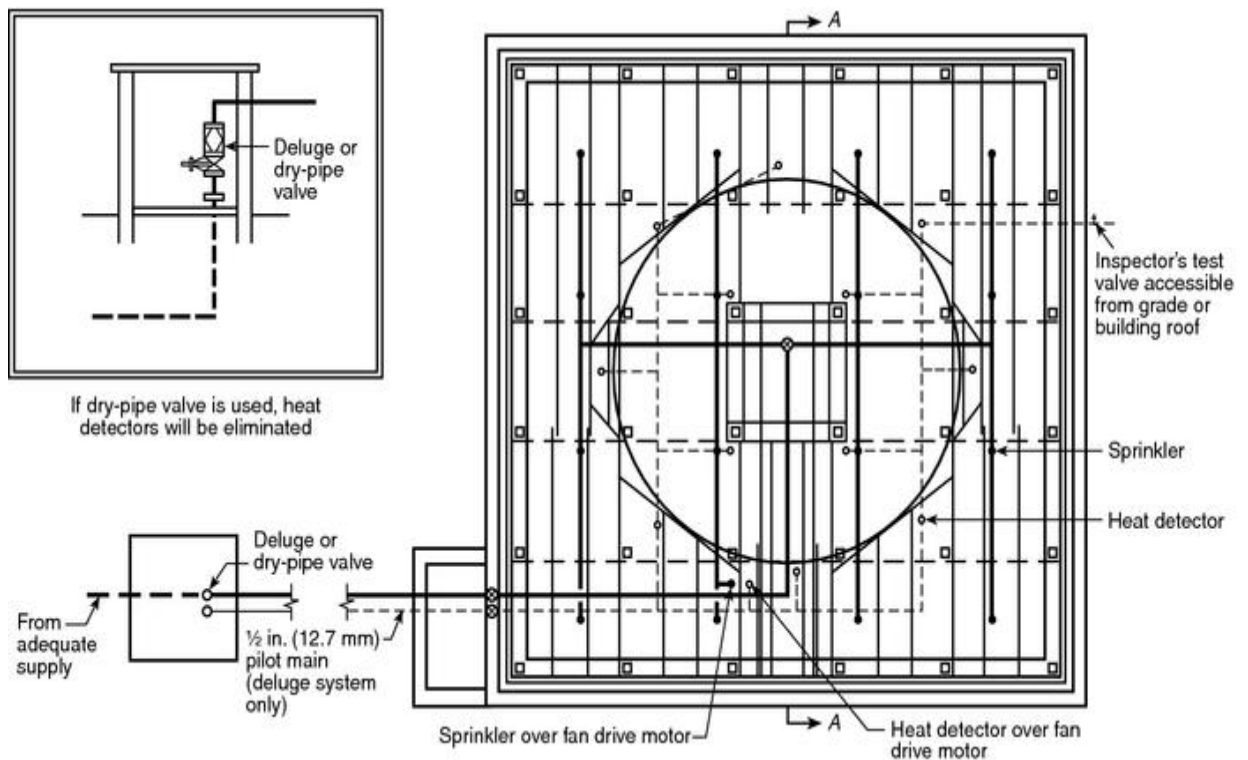

FIGURE A.21.24.2.1(c) Plan View, Typical Deluge or Dry Pipe Fire Protection

Arrangement for Counterflow Towers. [214:Figure A.5.2.4.1(c)]

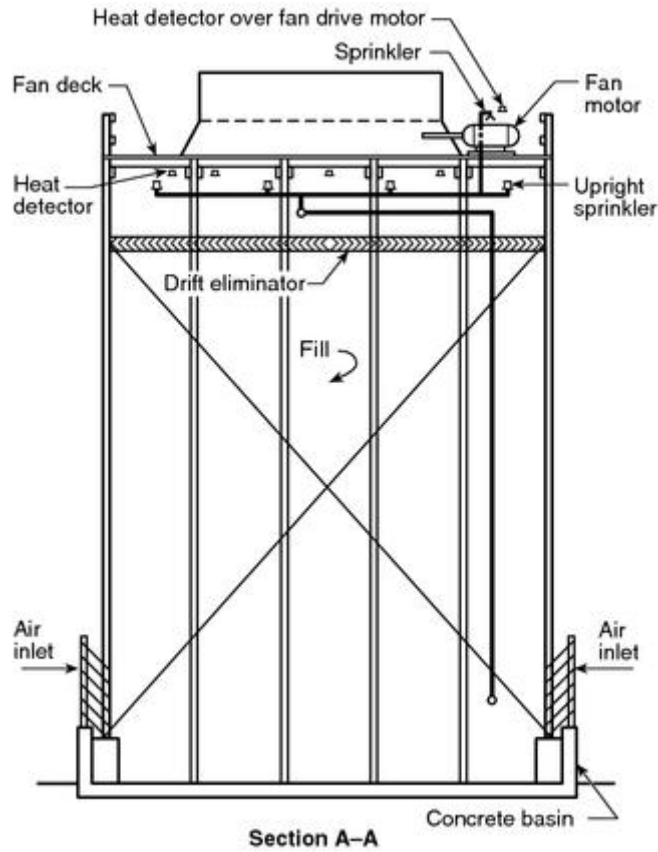

FIGURE A.21.24.2.1(d) Section View, Typical Deluge or Dry Pipe Fire Protection Arrangement for Counterflow Towers. [214:Figure A.5.2.4.1(d)]

A.21.24.2.2 See Figure A.21.24.2.2(a) through Figure A.21.24.2.2(d).

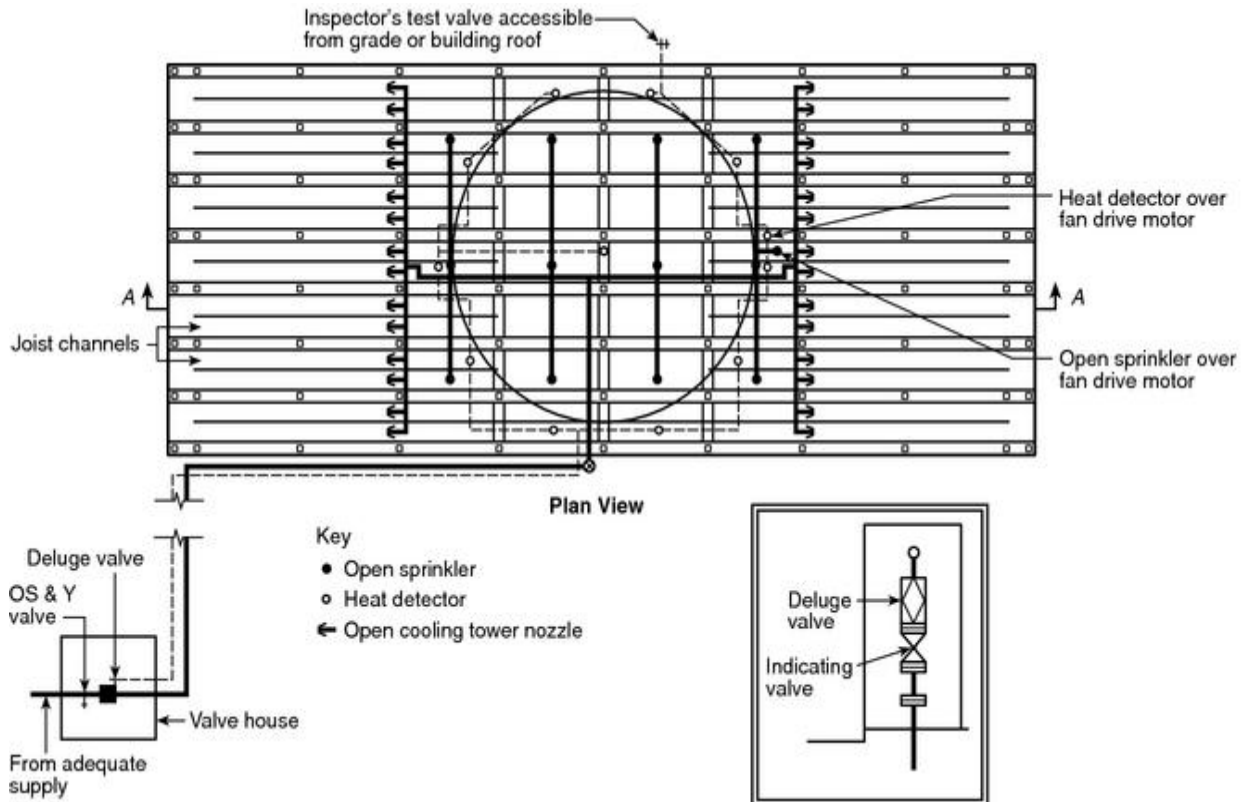

FIGURE A.21.24.2(a) Plan View, Typical Deluge Fire Protection Arrangement for Crossflow Towers. [214:Figure A.5.2.4.2(a)]

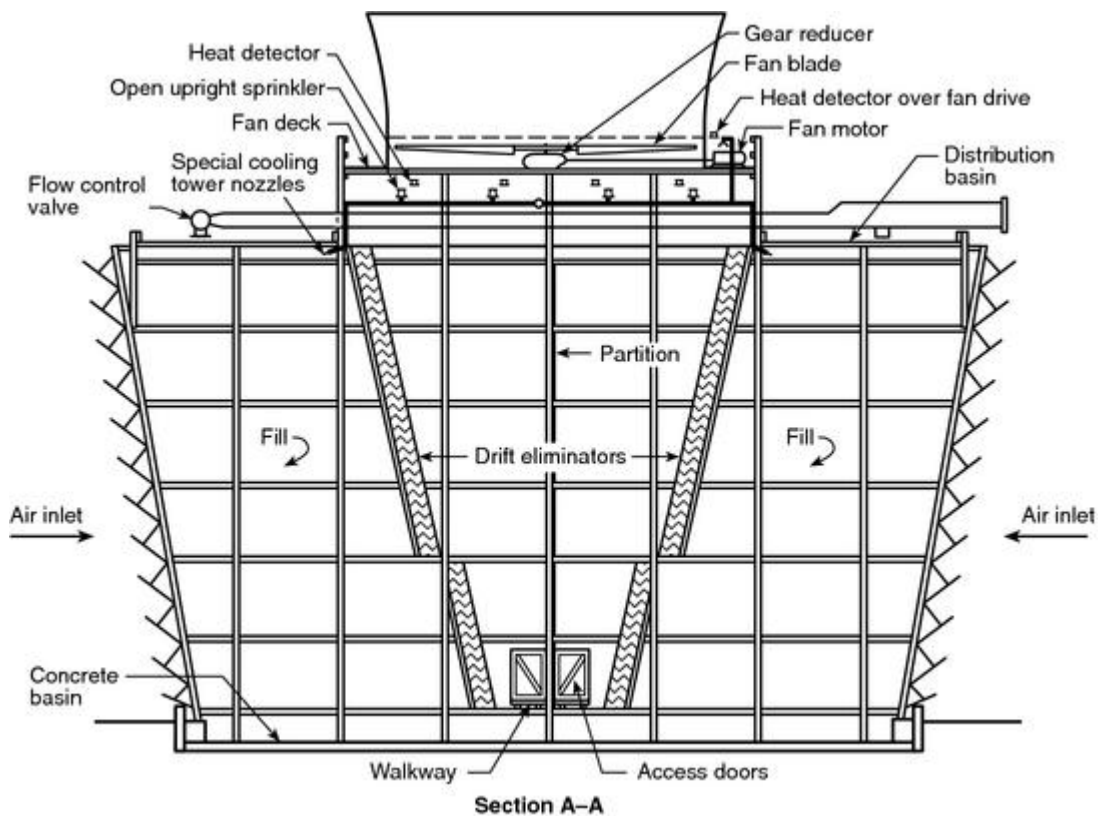
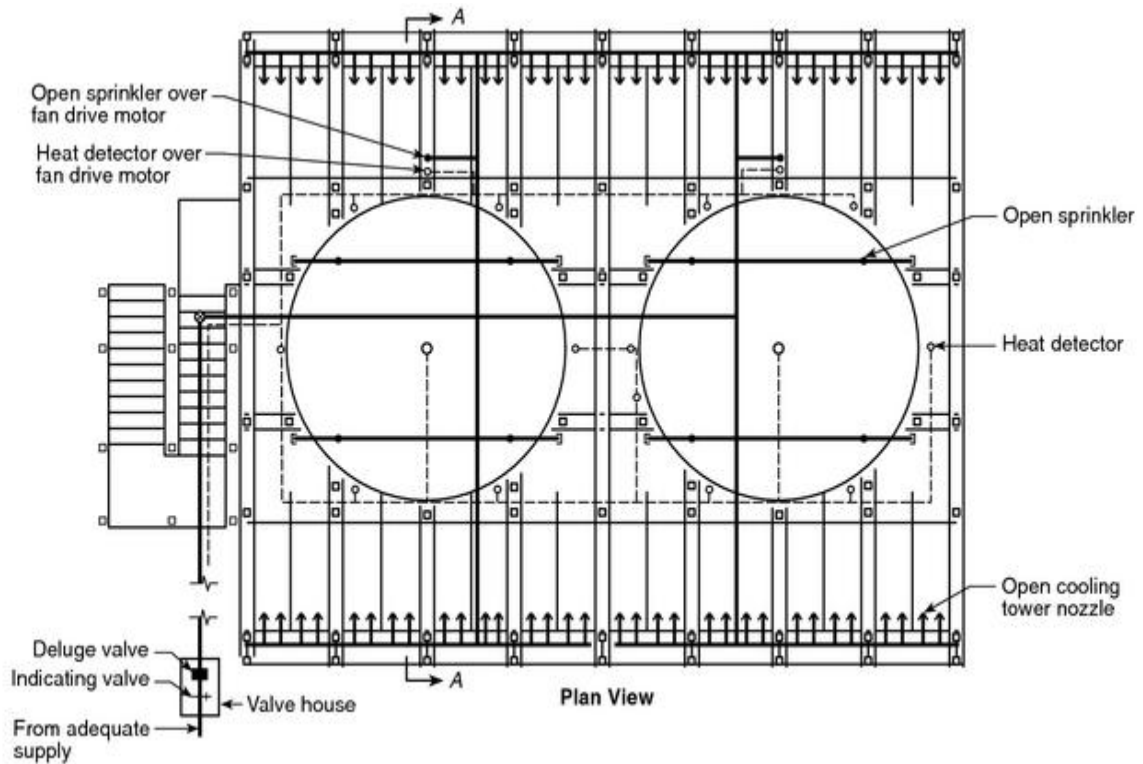
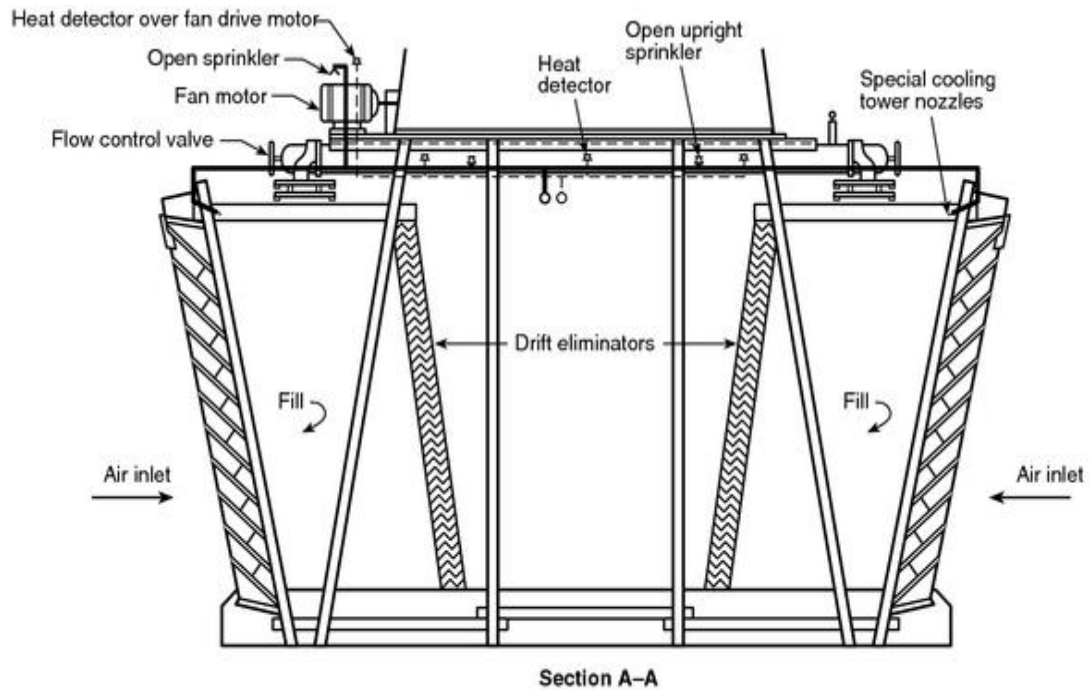

FIGURE A.21.24.2(b) Section View, Typical Deluge Fire Protection Arrangement for Crossflow Towers. [214:Figure A.5.2.4.2(b)]



Note: Where air seal boards prevent installation of cooling tower nozzles on drift eliminator side of fill, this nozzle location should be used.

FIGURE A.21.24.2(c) Plan View, Typical Deluge Fire Protection Arrangement for Multicell Crossflow Towers. [214:Figure A.5.2.4.2(c)]



Note: Where air seal boards prevent installation of cooling tower nozzles on drift eliminator side of fill, this nozzle location should be used.

FIGURE A.21.24.2.2(d) Section View, Typical Deluge Fire Protection Arrangement for Multicell Crossflow Towers. [214:Figure A.5.2.4.2(d)]

A.21.24.2.3 Location of the nozzle relative to surfaces to be protected should be determined by the particular nozzle's discharge characteristics. Care should also be taken in the selection of nozzles to obtain waterways not easily obstructed by debris, sediment, sand, and so forth, in the water. [See Figure A.21.24.2.3(a) and Figure A.21.24.2.3(b).] [214: A.5.2.4.3]

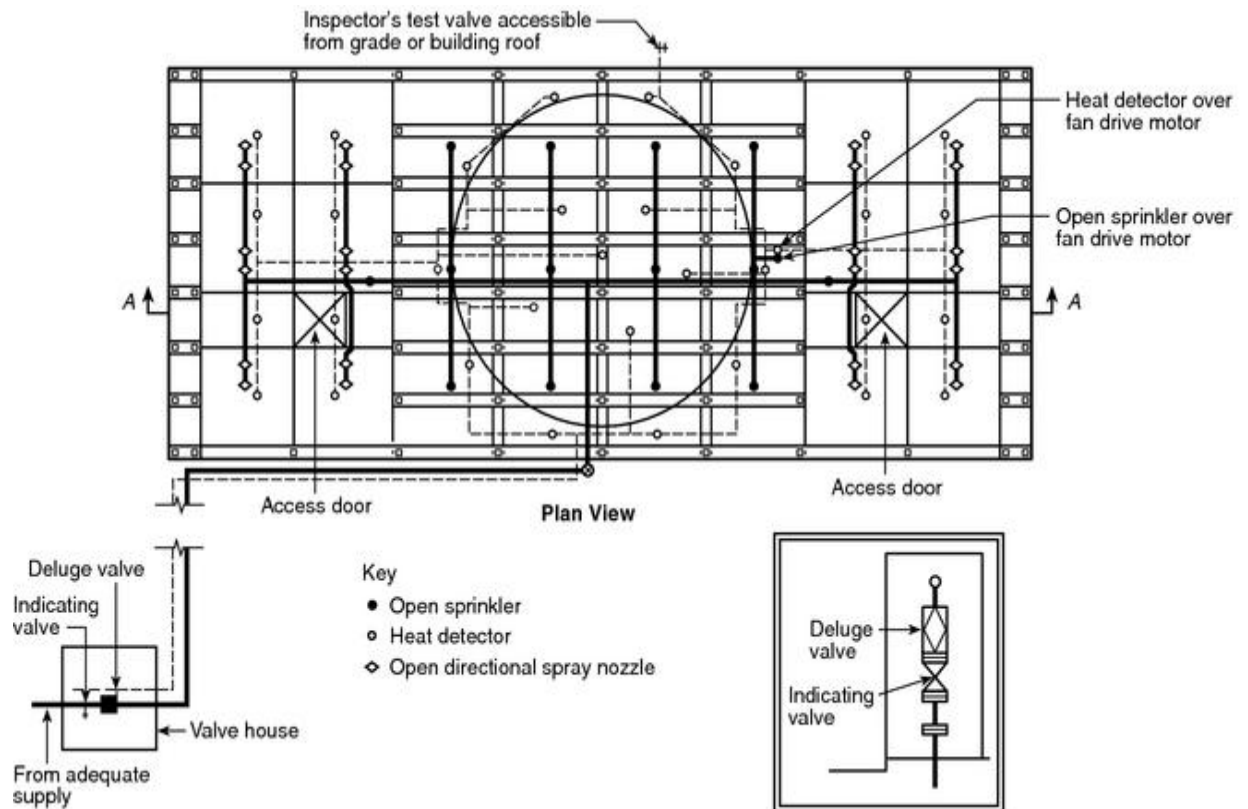

FIGURE A.21.24.2.3(a) Plan View, Typical Deluge Fire Protection Arrangement for Crossflow Towers with Completely Enclosed Distribution Basins. [214:Figure A.5.2.4.3(a)]

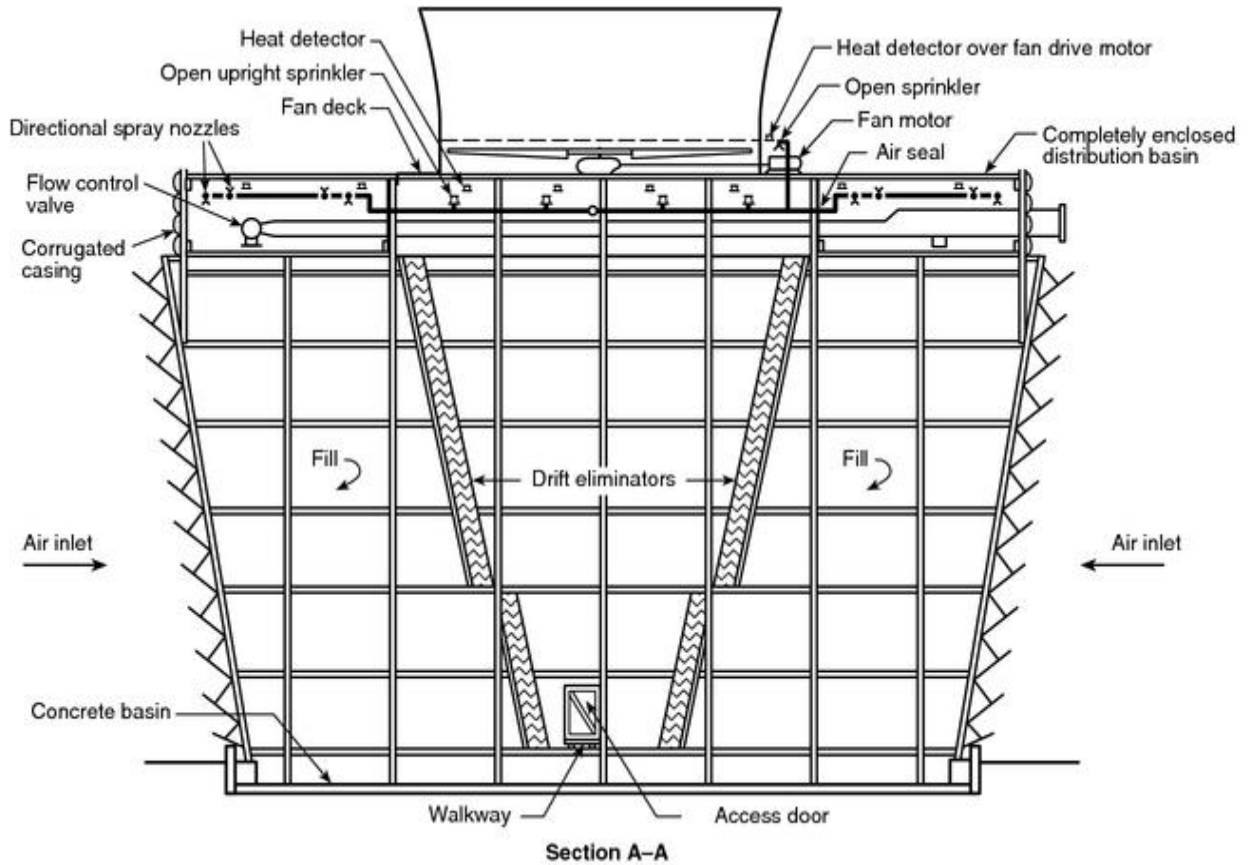

FIGURE A.21.24.2.3(b) Section View, Typical Deluge Fire Protection Arrangement for Crossflow Towers with Completely Enclosed Distribution Basins. [214:Figure A.5.2.4.3(b)]

A.21.24.2.5 See Figure A.21.24.2.5.

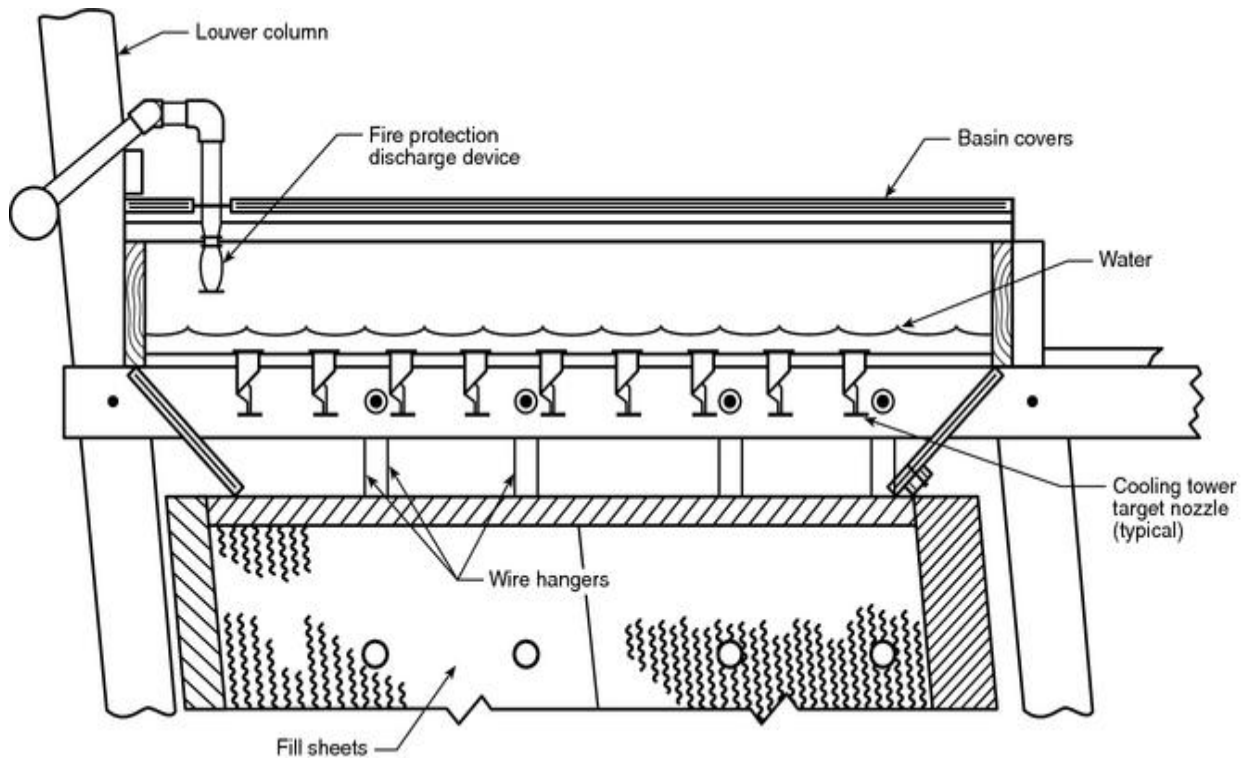

FIGURE A.21.24.2.5 Typical Deluge Fire Protection Arrangement for Crossflow Towers with Covers Completely Enclosing Distribution Basins. [214:Figure A.5.2.4.5]

A.21.24.2.10.2 Approved discharge devices are made of nonferrous material and are corrosion-resistant to normal atmospheres. Some atmospheres require special coatings on the discharge devices. [214: A.5.3.2]

A.21.24.2.10.3 Corrosion attacks the exposed metal and, in time, creeps under the wax coating. [214: A.5.3.3]

A.21.25.1.1 Group A plastics represent the most challenging commodities that can be protected by a sprinkler system designed in accordance with this standard. Due to the widely varying nature of commodities that pass through transit sheds, container freight stations, transload facilities, and similar buildings used for handling and temporary storage of general cargo, a minimum automatic sprinkler design based upon the protection of Group A plastic commodity provides an appropriate level of fire protection. [307: A.5.4.2.1]

A.21.25.2.1.2.1 Examples of sprinklers that project water upward are pendent sprinklers installed in an upright position or old-style sprinklers. [307: A.4.3.3.1.3.1]

A.21.25.2.1.2.1(B)(3) An example of crisscross construction (ties on stringers) is illustrated in Figure B.1(a) in NFPA 307, *Standard for the Construction and Fire Protection of Marine Terminals, Piers, and Wharves*. [307: A.4.3.3.1.3.1(B)(3)]

A.21.25.2.1.2.1(B)(5) The use of firestops for draft control (e.g., to bank heat, facilitate the opening of sprinkler heads, and prevent the overtaxing of the sprinkler system) is particularly important in the design of sprinkler protection for combustible substructures. The fire walls and firestops of 4.3.3.4 and 4.3.3.5 of NFPA 307 should be incorporated into the sprinkler

system design for draft control to the maximum extent practical; however, due to limitations in the size of the design area for the sprinkler system, additional firestops normally are needed. These additional or supplemental firestops need only have limited fire resistance, but they should be as deep as possible and be of substantial construction, such as double 3 in. (76.2 mm) planking, where exposed to the elements. Where not exposed to the possibility of physical damage, $\frac{3}{4}$ in. (19.05 mm) treated plywood extending 48 in. (1219.2 mm) below stringers with solid blocking between stringers should provide adequate durability and reasonable effectiveness. [307: A.4.3.3.1.3.1(B)(5)]

A.21.26.1.1 Typical configurations of cleanrooms and their chases and plenums create numerous areas that might be sheltered from sprinkler protection. These areas can include air-mixing boxes, catwalks, hoods, protruding lighting, open waffle slabs, equipment, piping, ducting, and cable trays. Care should be taken to relocate or supplement sprinkler protection to ensure that sprinkler discharge covers all parts of the occupancy. Care should also be taken to ensure that sprinklers are located where heat will be satisfactorily collected for reliable operation of the sprinkler.

Gaseous fire suppression systems are not substitutes for automatic sprinkler protection. The large number of air changes in cleanrooms can cause dilution or stratification of the gaseous agent.

It is recommended that sprinkler systems be inspected at least semiannually by a qualified inspection service. (See NFPA 25, *Standard for the Inspection, Testing, and Maintenance of Water-Based Fire Protection Systems*.) The length of time between such inspections can be decreased due to ambient atmosphere, water supply, or local requirements of the authority having jurisdiction.

Prior to taking a sprinkler system out of service, one should be certain to receive permission from all authorities having jurisdiction and to notify all personnel who might be affected during system shutdown. A fire watch during maintenance periods is a recommended precaution. Any sprinkler system taken out of service for any reason should be returned to service as promptly as possible.

A sprinkler system that has been activated should be thoroughly inspected for damage and its components replaced or repaired promptly. Sprinklers that did not operate but were subjected to corrosive elements of combustion or elevated temperatures should be inspected and replaced if necessary, in accordance with the minimum replacement requirements of the authority having jurisdiction. Such sprinklers should be destroyed to prevent their reuse. [318: A.4.1.2.1]

A.21.26.1.3 Small-orifice sprinklers, $\frac{3}{8}$ in. (9.5 mm) or larger, can be used. [318: A.4.1.2.6.2.1]

A.21.26.2.2 The use of quick-response sprinklers, while still delayed in opening by the downward airflow, would respond to a smaller-size fire more quickly than would conventional sprinklers. (Glass bulb-type quick-response sprinklers might be preferable to other types of quick-response sprinklers.) [318: A.4.1.2.2]

A.21.26.2.3 Small-orifice sprinklers, $\frac{3}{8}$ in. (9.5 mm) or larger, can be used. [318:

A.4.1.2.6.2.1]

A.21.28.1.2 The exposure to the airport terminal building from the airport ramp is significant. The number of building sprinklers operating from the exposure fire can be greater than from an internal ignition source. [415: A.4.5.1.5]

A.21.29.1.1 Because of the nature of the test cell fire potential, deluge systems are considered more appropriate than automatic sprinklers due to their speed of operation and simultaneous discharge of all nozzles; however, automatic sprinklers can be used under the following conditions:

- (1) In small cells [600 ft² (56 m²) or less] where it is likely that all sprinklers would fuse at the same time
- (2) As a backup to a manual water spray or other manual system [423: A.7.6.3]

A.21.30.1.1 Commodity refers to the definition in NFPA 13. [430: A.5.3.2]

A.21.30.2.1 Dry pipe and double-interlock preaction (DIPA) sprinkler systems are generally prohibited by 21.30.2.1 for use with oxidizers. In mercantile occupancies with open air environments that are already protected by these types of systems as prescribed by other codes, it is considered acceptable to store quantities defined by this code, with the recognition that these commodities may not be adequately protected. Outside storage in this manner is preferred to inside storage. [430: A.4.11.3]

A.21.32.1.1 The water supply for the permanent fire protection water system should be based on providing a 2-hour water supply for both items (1) and (2) as follows:

- (1) Either item (a) or (b), whichever is larger:
 - (a) The largest fixed fire suppression system demand
 - (b) Any fixed fire suppression system demand that could be reasonably expected to operate simultaneously during a single event (e.g., turbine underfloor protection in conjunction with other fire protection systems in the turbine area)
- (2) The hose stream demand of not less than 500 gpm (1892.5 L/min) [804: A.9.2.1]

A.21.32.1.5 To avoid water application to hot parts or other water-sensitive areas and to provide adequate coverage, designs that incorporate items such as fusible element operated spray nozzles might be necessary. [804: A.10.8.2.1]

A.21.32.1.6 Additional information concerning turbine generator fire protection can be found in EPRI Research Report 1843-2, "Turbine Generator Fire Protection by Sprinkler System." [804: A.10.8.3]

A.21.32.2.1.2 A common yard fire main loop can serve multi-unit nuclear power plant sites if it is cross-connected between units. [804: A.9.4.4]

A.21.34.1 Sprinkler System Discharge Criteria for Electric Generating Plants and High-Voltage Direct Current Converter Stations. See NFPA 850, *Recommended Practice for Fire Protection for Electric Generating Plants and High Voltage Direct*

Copyright NFPA

Current Converter Stations, for applicable terms not defined in Chapter 3.

- (1) *Sprinkler System Water Supply*. The water supply for the permanent fire protection installation should be based on providing a 2-hour supply for both A.21.34.1(a) and A.21.34.1(b) as follows:
 - (a) Either of the following, whichever is larger:
 - i. The largest fixed fire suppression system demand
 - ii. Any fixed fire suppression system demands that could reasonably be expected to operate simultaneously during a single event [e.g., turbine underfloor protection in conjunction with other fire protection system(s) in the turbine area, coal conveyor protection in conjunction with protection for related coal-handling structures during a conveyor fire, adjacent transformers not adequately separated according to 5.2.4 of NFPA 850].
 - (b) The hose stream demand of not less than 500 gpm (1840 L/min).
[850:6.2.1]
- (2) *Yard Mains*. The supply mains should be looped around the main power block and should be of sufficient size to supply the flow requirements determined by 6.2.1 of NFPA 850 to any point in the yard loop considering the most direct path to be out of service. Pipe sizes should be designed to encompass any anticipated expansion and future water demands. [850:6.4.1.3]
- (3) *Coal Handling Structures*. Sprinkler systems should be designed for a minimum of 0.25 gpm/ft² (10.2 mm/min) density over a 2500 ft² (232 m²) area. [850:7.4.6.1]
- (4) *Coal Conveyors*. Sprinklers should be designed for a minimum of 0.25 gpm/ft² (10.2 mm/min) density over 2000 ft² (186 m²) of enclosed area or the most remote 100 linear ft (30 m) of conveyor structure up to 2000 ft² (186 m²). [850:7.4.6.2]
- (5) [In areas over conveyor belts and striker plates within the stacker reclaimer,] the water supply [should] be from a 3000 gal to 5000 gal (11,355 L to 18,925 L) capacity pressure tank located on-board. [850:7.4.6.4]
- (6) Sprinklers for bag-type dust collectors should be designed for ordinary hazard systems. Sprinkler and water spray systems should be designed for a density of 0.2 gpm (8.1 mm/min) over the projected plan area of the dust collector. [850:7.4.6.5.1]
- (7) *Steam Generator*. Boiler front fire protection systems should be designed to cover the fuel oil burners and ignitors and adjacent fuel oil piping and cable a 20 ft (6.1 m) distance from the burner and ignitor, including structural members and walkways at these levels. Additional coverage should include areas where oil can collect. Sprinkler and water spray systems should be designed for a density of 0.25 gpm/ft² (10.2 mm/min) over the protected area. [850:7.5.1.2]
- (8) *Flue Gas Bag-Type Dust Collectors*. The design density should be 0.2 gpm/ft² (8.1 mm/min) over the plan area of the dust collector. [850:7.6.3.3]
- (9) *Electrostatic Precipitators*. If mineral oil insulating fluids are used, hydrants or

standpipes should be located so that each transformer-rectifier set can be reached by at least one hose stream. In addition the following should be provided:

Automatic sprinkler protection. Automatic sprinkler systems should be designed for a density of 0.25 gpm/ft² (10.2 mm/min) over 3500 ft² (325 m²). The drain system should be capable of handling oil spillage plus the largest design waterflow from the fire protection system. [850:7.6.4.3]

- (10) *Scrubber Buildings.* Where scrubbers have plastic or rubber linings, one of the following methods of protection for the building should be provided:
Automatic sprinkler protection at ceiling level sized to provide 0.2 gpm/ft² (8.1 mm/min). The area of operation should be the area of the building or 10,000 ft² (930 m²). Where draft curtains are provided, the area of operation can be reduced to the largest area subdivided by draft curtains. [850:7.6.5.2.2]
- (11) *Turbine-Generator Area.* The sprinkler system beneath the turbine-generator should take into consideration obstructions from structural members and piping and should be designed to a density of 0.3 gpm/ft² (12.2 mm/min) over a minimum application of 5000 ft² (464 m²). [850:7.7.4.1, 7.7.4.1.1]
The automatic sprinkler system [protecting the lubricating oil lines above the turbine operating floor] should be designed to a density of 0.3 gpm/ft² (12.2 mm/min). [850:7.7.4.1.2]
- (12) *Turbine-Generator Bearings.* Fire protection systems for turbine-generator bearings should be designed for a density of 0.25 gpm/ft² (10.2 mm/min) over the protected area of all bearings. [850:7.7.4.2.1]
- (13) *Cable Spreading Room and Cable Tunnels.* Automatic sprinkler systems should be designed for a density of 0.3 gpm/ft² (12.2 mm/min) over 2500 ft² (232 m²) or the most remote 100 linear ft (30 m) of cable tunnels up to 2500 ft² (232 m²). [850:7.8.2.1]
- (14) *Emergency Generators.* Sprinkler systems should be designed for a 0.25 gpm/ft² (10.2 mm/min) density over the fire area. [850:5.9.1.2.1]
- (15) *Fire Pumps.* If sprinkler systems are provided for fire pump houses, they should be designed for a density of 0.25 gpm/ft² (10.2 mm/min) over the fire area. [850:7.9.4]
- (16) *Oil- or Coal-Fueled Auxiliary Boilers.* If a sprinkler system is provided, it should be designed for a density of 0.25 gpm/ft² (10.2 mm/min) over the entire room.
- (17) *Alternative Fuels.*
 - (a) *Hydraulic Equipment, Reservoirs, Coolers, and Associated Oil-Filled Equipment.* Sprinklers should be over oil-containing equipment and for 20 ft (6.1 m) beyond in all directions. A density of 0.25 gpm/ft² (10.2 mm/min) should be provided. [850:9.1.5.3]
 - (b) *Tipping/Receiving Building.* Systems should be designed for a minimum of 0.25 gpm/ft² (10.2 mm/min) over the most remote 3000 ft² (279 m²) (increase by 30 percent for dry pipe systems) of floor area with the protection area per sprinkler

not to exceed 130 ft² (12 m²). High-temperature sprinklers [250°F to 300°F (121°C to 149°C)] should be used. [850:9.3.3.1]

- (c) *The MSW Storage Pit, Charging Floor, and Grapple Laydown Areas.* Systems should be designed for a minimum of 0.2 gpm/ft² (8.1 mm/min) over the most remote 3000 ft² (279 m²) (increase by 30 percent for dry pipe systems) of pit/floor area with the protection area per sprinkler not to exceed 100 ft² (9.3 m²). High-temperature sprinklers [250°F to 300°F (121°C to 149°C)] should be used. [850:9.3.3.2.1]
- (18) *Refuse-Derived Fuels.*
- (a) *Hydraulic Equipment, Reservoirs, Coolers, and Associated Oil-Filled Equipment.* Sprinklers should be over oil-containing equipment and for 20 ft (6.1 m) beyond in all directions. A density of 0.25 gpm/ft² (10.2 mm/min) should be provided. [850:7.4.4.6]
- (b) *Tipping/Receiving Building.* Systems should be designed for a minimum of 0.25 gpm/ft² (10.2 mm/min) over the most remote 3000 ft² (279 m²) (increase by 30 percent for dry pipe systems) of floor area with the protection area per sprinkler not to exceed 130 ft² (12.0 m²). High temperature sprinklers [250°F to 300°F (121°C to 149°C)] should be used.
NOTE: The preceding requirements are based on storage heights not exceeding 20 ft (6.1 m). [850:7.4.4.7]
- (c) *Processing Building.* Systems should be designed for a minimum of 0.25 gpm/ft² (10.2 mm/min) over the most remote 3000 ft² (279 m²) (increase by 30 percent for dry pipe systems) of floor area with the protection area per sprinkler not to exceed 130 ft² (12.0 m²). [850:7.4.4.8]
- (d) *RDF Storage Building.* Systems should be designed for a minimum of 0.35 gpm/ft² (14.3 mm/min) over the most remote 3000 ft² (279 m²) (increase by 30 percent for dry pipe systems) of floor area with the protection area per sprinkler not to exceed 100 ft² (9.3 m²). High-temperature sprinklers [250°F to 300°F (121°C to 149°C)] should be used. Storage heights in excess of 20 ft (6.1 m) will require higher design densities. [850:7.4.4.9]
- (e) *RDF Boiler Feed System Area, Including Bins, Hoppers, Chutes, Conveyors, and So Forth.* Where provided, the systems should be designed for a minimum of 0.2 gpm/ft² (8.2 mm/min) over the most remote 2000 ft² (186 m²) (increase by 30 percent for dry pipe systems) of floor area with the protection area per sprinkler not to exceed 130 ft² (12.0 m²). Internal, as well as external, protection also should be considered depending upon specific equipment design, ceiling heights, and accessibility for manual fire fighting. [850:7.4.4.10]
- (f) *Shredder Enclosures.* Systems should be designed for a minimum of 0.25 gpm/ft² (10.2 mm/min) over the most remote 3000 ft² (279 m²) (increase by 30 percent for dry pipe systems) of floor area with the protection area per sprinkler

not to exceed 100 ft² (9.3 m²). [850:7.4.4.11]

(19) *Biomass Fuels.*

- (a) *Biomass Storage Buildings.* Systems should be designed for a minimum of 0.25 gpm/ft² (10.2 mm/min) over the most remote 3000 ft² (279 m²) (increase by 30 percent for dry pipe systems) of floor area with the protection area per sprinkler not to exceed 130 ft² (12.0 m²).

NOTE: Biomass fuels exhibit a wide range of burning characteristics and upon evaluation can require increased levels of protection.

[850:7.5.4.4]

- (b) *Hydraulic Equipment, Reservoirs, Coolers, and Associated Oil-Filled Equipment.* Sprinklers or spray nozzles should be over oil-containing equipment and for 20 ft (6.1 m) beyond in all directions. A density of 0.25 gpm/ft² (10.2 mm/min) should be provided. [850:7.5.4.6]

- (20) *Rubber Tire Fuel — Hydraulic Equipment, Reservoirs, Coolers, and Associated Oil-Filled Equipment.* Sprinklers should be over oil-containing equipment and for 20 ft (6.1 m) beyond in all directions. A density of 0.25 gpm/ft² (10.2 mm/min) should be provided. [850:7.6, 7.6.4.10]

A.21.34.2 Where an adequate and reliable water supply, such as a lake, cooling pond, river, or municipal water system, is unavailable, at least two separate water supplies should be provided for fire protection purposes, with each supply capable of meeting the fire waterflow requirements determined by 4.2.1 of NFPA 850, *Recommended Practice for Fire Protection for Electric Generating Plants and High Voltage Direct Current Converter Stations*. [850:4.2.2]

Each water supply should be connected to the yard main by separate connections arranged and valve controlled to minimize the possibility of multiple supplies being impaired simultaneously. [850:4.2.3]

Indicator control valves should be installed to provide adequate sectional control of the fire main loop to minimize plant protection impairments. [850:4.4.1.4)]

Each hydrant should be equipped with a separate shutoff valve located on the branch connection to the supply main. [850:4.4.1.5]

Interior fire protection loops are considered an extension of the yard main and should be provided with at least two valved connections to the yard main with appropriate sectional control valves on the interior loop. [850:4.4.1.6]

If a sprinkler system is used to protect the coal conveyor, particular care should be exercised in locating closed sprinkler so that they will be in the path of the heat produced by the fire and still be in a position to provide good coverage of all belt surfaces along the conveyor. [850:5.4.6.2.1]

Protection inside dust collectors should include the clean air plenum and the bag section. If the hopper is shielded from water discharge, sprinklers also should be provided in the hopper section.

All areas beneath the turbine-generator operating floor that are subject to oil flow, oil spray, or oil accumulation should be protected by an automatic sprinkler or foam-water sprinkler system. This coverage normally includes all areas beneath the operating floor in the turbine building. [850:5.7.4.1.1]

Lubricating oil lines above the turbine operating floor should be protected with an automatic sprinkler system covering those areas subject to oil accumulation including the area within the turbine lagging (skirt). [850:5.7.4.1.2]

Turbine-generator bearings should be protected with a manually or automatically operated closed-head sprinkler system utilizing directional nozzles. [850:5.7.4.2.1]

Due to the large quantity of platforms, equipment, and walkways, care should be taken to include coverage under all obstructions greater than 4 ft (1.2 m) wide. (850: 7.4.4.8)

A.21.35.1 Sprinkler System Discharge Criteria for Hydroelectric Generating Plants.

See NFPA 851, *Recommended Practice for Fire Protection for Hydroelectric Generating Plants*, for applicable terms not defined in Chapter 3.

- (1) *Sprinkler Systems Water Supply.* The water supply for the permanent fire protection installation should be based on the largest fixed fire suppression system demand plus the maximum hose stream demand of not less than 500 gpm (31.5 L/sec) for a 2-hour duration. [851:4.2.2]
- (2) If a single water supply is utilized, two independent connections should be provided. If a situation can arise in which the primary water supply can become unavailable (e.g., dewatering of penstocks), an auxiliary supply should be provided. Each supply should be capable of meeting the requirements in 4.2.2 of NFPA 851. [851:4.2.3]
- (3) Fixed fire protection for this equipment, where provided, should be automatic wet pipe sprinkler systems utilizing a design density of 0.25 gpm/ft² (10.2 mm/min) for the entire hazard area (*see 3.5.3 of NFPA 803*). [851:5.2.4]
- (4) Sprinkler or water spray systems should be designed for a density of 0.3 gpm/ft² (12.2 mm/min) over 2500 ft² (232 m²). This coverage is for area protection. Individual cable tray tier coverage could be required based on the fire risk evaluation. [851:5.5.3]
- (5) *Cable Tunnels.* Automatic sprinkler systems should be designed for a density of 0.3 gpm/ft² (12.2 mm/min) over 2500 ft² (232 m²) or the most remote 100 linear ft (30 m) of cable tunnel up to 2500 ft² (232 m²). [851:5.6.1]
- (6) *Emergency Generators.* Sprinkler and water spray protection systems should be designed for a 0.25 gpm/ft² (10.2 mm/min) density over the fire area. [851:5.11.2]
- (7) *Air Compressors.* Automatic sprinkler protection, with a density of 0.25 gpm/ft² (10.2 mm/min) over the postulated oil spill, should be considered for air compressors containing a large quantity of oil. (*See 4.8.2 of NFPA 851, Recommended Practice for Fire Protection for Hydroelectric Generating Plants.*) [851:5.12]
- (8) *Hydraulic Systems for Gate and Valve Operators.* Automatic sprinkler protection

designed for a density of 0.25 gpm/ft² (10.2 mm/min) over the fire area should be considered for hydraulic systems not using a listed fire-resistant fluid. (See 4.8.2 of NFPA 851.) [851:5.13]

- (9) *Fire Pumps.* If sprinkler systems are provided, they should be designed for a density of 0.25 gpm/ft² (10.2 mm/min) over the fire area. For automatic foam-water sprinkler systems, a density of 0.16 gpm/ft² (6.5 mm/min) should be provided. [851:5.14]

A.21.35.2 Upstream water is frequently the fire protection water supply. Water for fire suppression should not be taken downstream from any closure device in a penstock, flume, or forebay. [851:4.2.6]

Fire extinguishing systems, where installed for lube oil systems employing combustible-type oil, should include protection for the reservoirs, pumps, and all oil lines, especially where unions exist on piping and beneath any shielded area where flowing oil can collect. Facilities not provided with curbs or drains should extend coverage for a distance of 20 ft (6.1 m) from the oil lines, when measured from the outermost oil line. [851:5.2.7]

A.21.36.1 Sprinkler systems for specific areas associated with religious facilities should be designed as follows:

- (1) All assembly areas, except state — light hazard
- (2) Stages — ordinary hazard (Group 2)
- (3) Kitchens — ordinary hazard (Group 1)
- (4) Storage rooms — ordinary hazard (Group 2)
- (5) Unused attics/lofts/steeple/concealed spaces — light hazard
- (6) Schools/day-care centers — light hazard
- (7) Gift shops — ordinary hazard (Group 1)
- (8) Special exhibit area — ordinary hazard (Group 2)
- (9) Libraries — ordinary hazard (Group 2)
- (10) Offices — light hazard [909: A.10.4.2]

A.21.36.1.1 Standard-response sprinklers employ more robust operating elements than quick-response sprinklers and can be more appropriate for use in areas where concern for inadvertent water discharge outweighs the advantages of thermal sensitivity. [909: A.12.4.4.2]

A.21.36.1.2.1 The automatic fire suppression system, the compact storage system, and the storage compartmentation features should be designed to limit fire damage in accordance with the facility's fire safety objectives (e.g., confine fire growth to the compact storage module of origin). Significant factors to consider include the number and size of the storage modules, the separation provided between the modules (end-to-end and back-to-back), and the type of materials being stored. In general, double-interlock pre-action systems and dry pipe systems are inappropriate for compact storage, because of the additional delay they introduce, coupled with the delays in activation resulting from the compact storage units

Copyright NFPA

themselves.

Other protection features, which should be considered to limit the extent of potential fire damage, include the following:

- (1) Very high density sprinkler systems
- (2) Quick-response sprinklers
- (3) Early-warning smoke detection
- (4) Spacers between carriages or, for automated systems, automatic park mode to increase flue spaces between carriages upon activation of a fire alarm or during idle periods
- (5) Metal vertical barriers in the middle of the shelf
- (6) Open-top shelving
[909: A.16.4.8.1.3]

A.21.36.1.2.2 The system should be designed to confine fire growth to the compact storage module of origin or the shelving range of origin. [909: A.16.4.8.1.4.1]

A.22.1 Preliminary plans should be submitted for review to the authority having jurisdiction prior to the development of working plans [see *Figure A.22.1(a)*]. The preliminary plans can be part of the construction documents submitted in order to obtain a building permit. However, working drawings in accordance with Section 22.1 should be submitted and approved prior to the installation of system equipment. Preliminary plans should include as much information as is required to provide a clear representation of the hazard to be protected, the system design concept, the proposed water supply configuration, and building construction information pertinent to system layout and detailing.

The owner's information certificate, shown as *Figure A.22.1(b)*, should be used to obtain a declaration of the intended use of the occupancy to be protected.

Drawings that accompany the certificate should include the following:

- (1) Name of owner and occupant.
- (2) Location, including street address.
- (3) Point of compass.
- (4) Construction and occupancy of each building.
- (5) Building height in feet.
- (6) Waterflow test information. If a waterflow test of the city main is available, the drawings should indicate the date and time of the test, the name of the party that conducted the test, the location of the hydrants where the flow was taken and where static and residual pressure readings were recorded (*see A.23.2.1*), the size and configuration of mains supplying the hydrants, the size and number of open hydrant butts flood, and results of the test.
- (7) Building features such as combustibles concealed spaces, floor openings, areas subject

to freezing, and areas from which it is intended to omit sprinkler protection.

- (8) Proposed location and approximate size, if a water supply employing pumps or tanks is contemplated.
- (9) Name and address of party submitting the preliminary plans.
- (10) Tentative location of underground major piping, including mains, risers, overhead mains, and fire department connections.

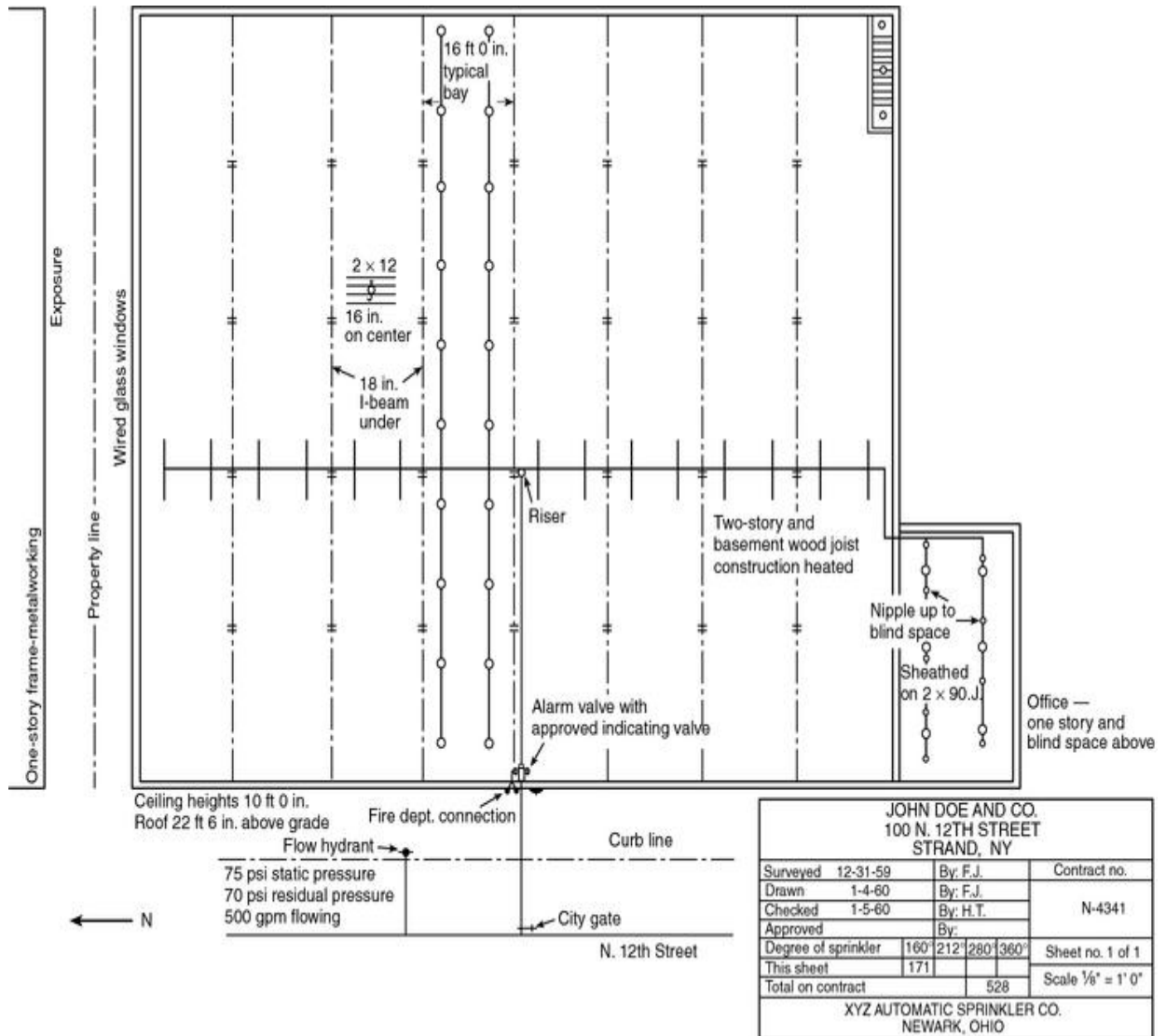

FIGURE A.22.1(a) Typical Preliminary Plan.

Owner's Information Certificate

Name/Address of property to be protected with sprinkler protection:

Name of Owner: _____

Existing or planned construction is:

- Fire resistive or noncombustible
- Wood frame or ordinary (masonry walls with wood beams)
- Unknown

Is the system installation intended for one of the following special occupancies:

- | | | |
|---------------------------------|------------------------------|-----------------------------|
| Aircraft hangar | <input type="checkbox"/> Yes | <input type="checkbox"/> No |
| Fixed guideway transit system | <input type="checkbox"/> Yes | <input type="checkbox"/> No |
| Race track stable | <input type="checkbox"/> Yes | <input type="checkbox"/> No |
| Marine terminal, pier, or wharf | <input type="checkbox"/> Yes | <input type="checkbox"/> No |
| Airport terminal | <input type="checkbox"/> Yes | <input type="checkbox"/> No |
| Aircraft engine test facility | <input type="checkbox"/> Yes | <input type="checkbox"/> No |
| Power plant | <input type="checkbox"/> Yes | <input type="checkbox"/> No |
| Water-cooling tower | <input type="checkbox"/> Yes | <input type="checkbox"/> No |

If the answer to any of the above is "yes," the appropriate NFPA standard should be referenced for sprinkler density/area criteria.

Indicate whether any of the following special materials are intended to be present:

- | | | |
|---------------------------------------|------------------------------|-----------------------------|
| Flammable or combustible liquids | <input type="checkbox"/> Yes | <input type="checkbox"/> No |
| Aerosol products | <input type="checkbox"/> Yes | <input type="checkbox"/> No |
| Nitrate film | <input type="checkbox"/> Yes | <input type="checkbox"/> No |
| Pyroxylin plastic | <input type="checkbox"/> Yes | <input type="checkbox"/> No |
| Compressed or liquefied gas cylinders | <input type="checkbox"/> Yes | <input type="checkbox"/> No |
| Liquid or solid oxidizers | <input type="checkbox"/> Yes | <input type="checkbox"/> No |
| Organic peroxide formulations | <input type="checkbox"/> Yes | <input type="checkbox"/> No |
| Idle pallets | <input type="checkbox"/> Yes | <input type="checkbox"/> No |

If the answer to any of the above is "yes," describe type, location, arrangement, and intended maximum quantities.

FIGURE A.22.1(b) Owner's Information Certificate.

Indicate whether the protection is intended for one of the following specialized occupancies or areas:

- | | | |
|--|------------------------------|-----------------------------|
| Spray area or mixing room | <input type="checkbox"/> Yes | <input type="checkbox"/> No |
| Solvent extraction | <input type="checkbox"/> Yes | <input type="checkbox"/> No |
| Laboratory using chemicals | <input type="checkbox"/> Yes | <input type="checkbox"/> No |
| Oxygen-fuel gas system for welding or cutting | <input type="checkbox"/> Yes | <input type="checkbox"/> No |
| Acetylene cylinder charging | <input type="checkbox"/> Yes | <input type="checkbox"/> No |
| Production or use of compressed or liquefied gases | <input type="checkbox"/> Yes | <input type="checkbox"/> No |
| Commercial cooking operation | <input type="checkbox"/> Yes | <input type="checkbox"/> No |
| Class A hyperbaric chamber | <input type="checkbox"/> Yes | <input type="checkbox"/> No |
| Cleanroom | <input type="checkbox"/> Yes | <input type="checkbox"/> No |
| Incinerator or waste handling system | <input type="checkbox"/> Yes | <input type="checkbox"/> No |
| Linen handling system | <input type="checkbox"/> Yes | <input type="checkbox"/> No |
| Industrial furnace | <input type="checkbox"/> Yes | <input type="checkbox"/> No |
| Water-cooling tower | <input type="checkbox"/> Yes | <input type="checkbox"/> No |

If the answer to any of the above is "yes," describe type, location, arrangement, and intended maximum quantities.

Will there be any storage of products over 12 ft (3.6 m) in height?

Yes No

If the answer is "yes," describe product, intended storage arrangement, and height. _____

Will there be any storage of plastic, rubber, or similar products over 5 ft (1.5 m) high except as described above?

Yes No

If the answer is "yes," describe product, intended storage arrangement, and height. _____

I certify that I have knowledge of the intended use of the property and that the above information is correct.

Signature of owner's representative or agent: _____

Date: _____

Name of owner's representative or agent completing certificate (print): _____

Relationship and firm of agent (print): _____

FIGURE A.22.1(b) Continued

A.22.1.1 See Figure A.22.1.1. Underground mains should be designed so that the system can be extended with a minimum of expense. Possible future plant expansion should also be considered and the piping designed so that it will not be covered by buildings.

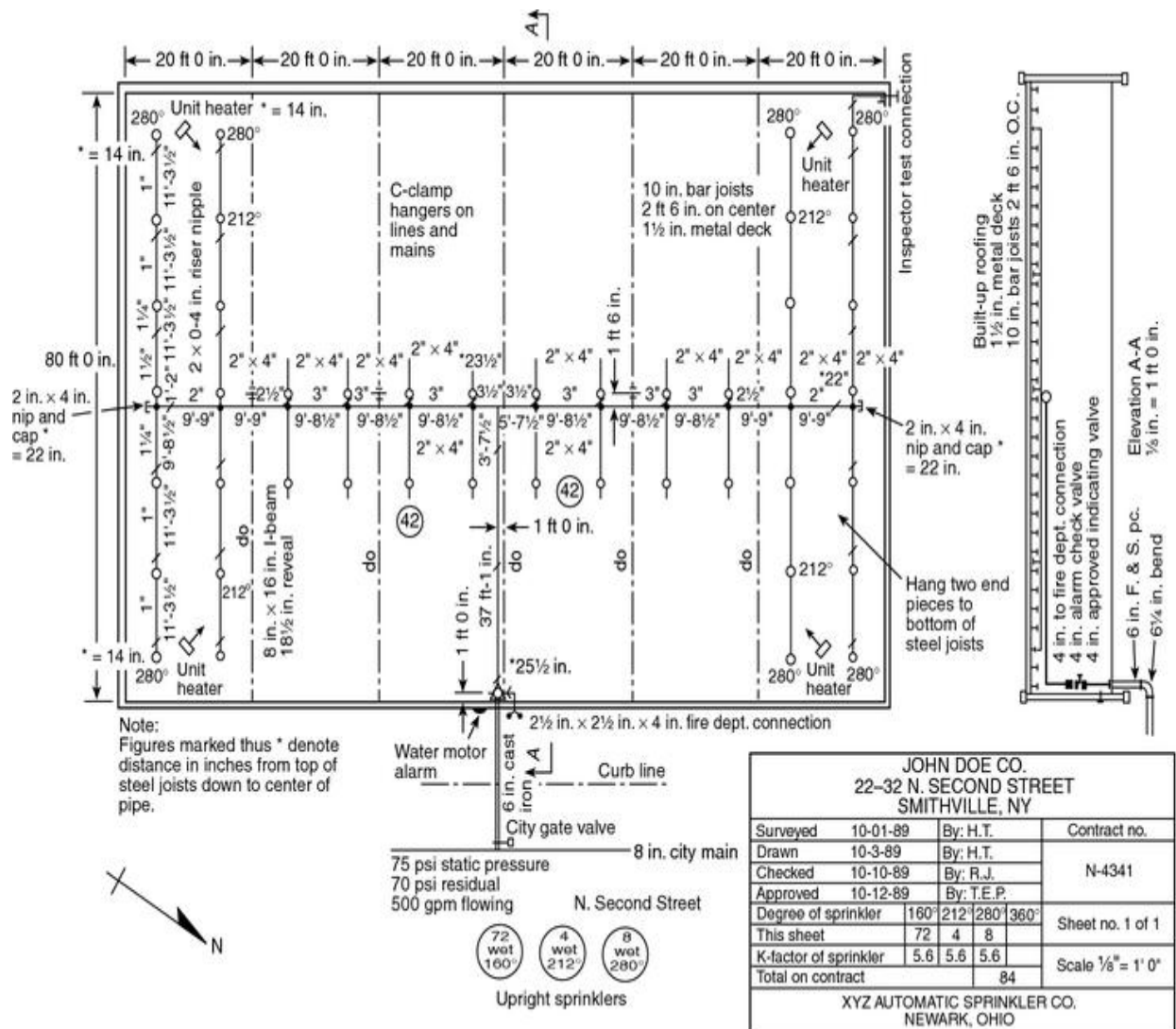

FIGURE A.22.1.1 Typical Working Plans.

A.22.1.4 It is the intent to provide the owner's certificate for all new systems and where there is a change of occupancy and/or building use.

A.22.1.5 See Figure A.22.1.5(a) and Figure A.22.1.5(b).

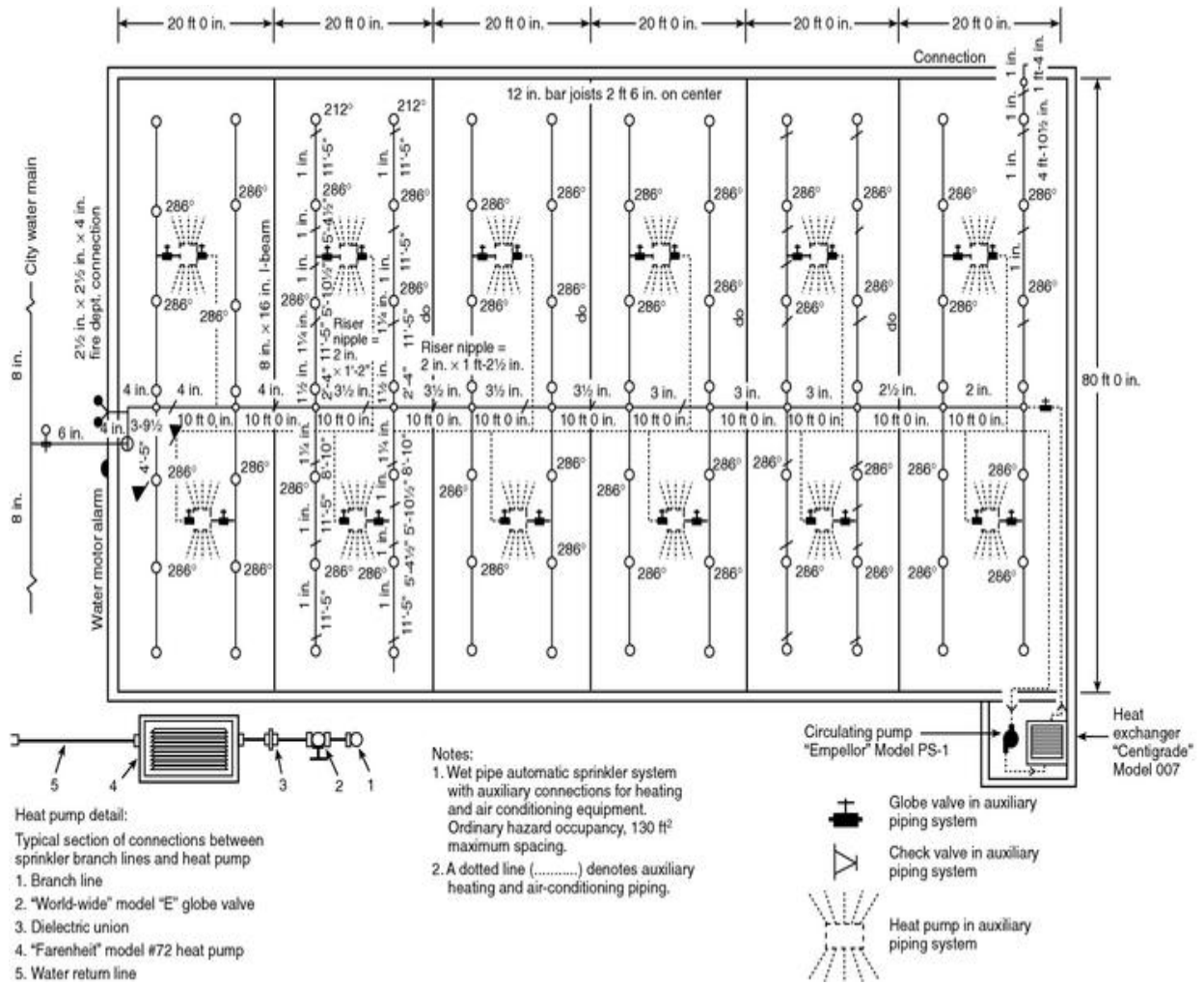

FIGURE A.22.1.5(b) Working Plans for Circulating Closed-Loop Systems (Example 2).

A.22.3.2 See Figure A.22.3.2(a) through Figure A.22.3.2(d).

Hydraulic Calculations

for

ABC Company, employee garage

7499 Franklin Road

Charleston, SC

Contract No. 4001

Date 1-7-99

Design

Occupancy classification ORD. GR. 1

Density 0.15 gpm/ft²

Area of application 1500 ft

Coverage per sprinkler 130 ft

Special sprinklers

No. of sprinklers calculated 12

In-rack demand

Hose streams 250 gpm

Total water required 510.4 gpm
including hose streams

Name of contractor

Name of designer

Address

Authority having jurisdiction

FIGURE A.22.3.2(a) Summary Sheet.

Contract Name <u>GROUP I 1500 ft²</u> Sheet <u>2</u> Of <u>3</u>										
Step No.	Nozzle Ident. and Location	Flow in gpm	Pipe Size	Pipe Fittings and Devices	Equiv. Pipe Length	Friction Loss psi Foot	Pressure Summary	Normal Pressure	D = 0.15 GPM/ ft ² Notes K = 5.6	Ref. Step
1	1 BL-1	q	1	L 13.0	C=120	0.12	P _t 12.1	P _t	Q = 130 x 0.15 = 19.5 P = (19.5/5.6) ² = 12.1 psi	
				F			P _e	P _v		
		Q 19.5		T 13.0			P _f 1.6	P _n		
2	2	q 20.7	1 1/4	L 13.0	0.125	0.125	P _t 13.7	P _t	q = 5.6 √13.7	
				F			P _e	P _v		
		Q 40.2		T 13.0			P _f 1.6	P _n		
3	3	q 21.9	1 1/2	L 13.0	0.131	0.131	P _t 15.3	P _t	q = 5.6 √15.3	4
				F			P _e	P _v		
		Q 62.1		T 13.0			P _f 1.7	P _n		
4	4 DN RN	q 23.1	1 1/2	2T-16 L 20.5	0.236	0.236	P _t 17.0	P _t	q = 5.6 √17 P _e = 1 x 0.433	5
				F 16.0			P _e 0.4	P _v		
		Q 85.2		T 36.5			P _f 8.6	P _n		
5	5 CM TO BL-2	q	2	L 10.0	0.07	0.07	P _t 26.0	P _t	K = $\frac{85.2}{\sqrt{26}}$ K = 16.71	
				F			P _e	P _v		
		Q 85.2		T 10.0			P _f 0.7	P _n		
6	6 BL-2 CM TO BL-3	q 86.3	2 1/2	L 10.0	0.107	0.107	P _t 26.7	P _t	q = 16.71 √26.7	6
				F			P _e	P _v		
		Q 171.5		T 10.0			P _f 1.1	P _n		
7	7 BL-3 CM	q 88.1	2 1/2	L 70.0	0.231	0.231	P _t 27.8	P _t	q = 16.7 √27.8	
				F			P _e	P _v		
		Q 259.6		T 70.0			P _f 16.2	P _n		
8	8 CM TO FIS	q	3	E5 L 119.0	0.081	0.081	P _t 44.0	P _t	P _e = 15 x 0.433	8
				AV15 F 21			P _e 6.5	P _v		
		Q 259.6		GV1 T140.0			P _f 11.2	P _n		
9	9 THROUGH UNDER- GROUND TO CITY MAIN	q	3	E5 L 50.0	C=150 TYPE 'M'	0.061	P _t 61.7	P _t	F = F ₄₀ x 1.51 x F _c F _c = [2.981/3.068] ^{4.87} = 0.869 F = 21 x 1.51 x 0.869 F = 27.6	9
				GV1 F 27.6			P _e	P _v		
		Q 259.6		T15 T 77.6			P _f 4.7	P _n		
		q		L			P _t 66.4	P _t		
				F			P _e	P _v		
		Q		T			P _f	P _n		
		q		L			P _t	P _t		
				F			P _e	P _v		
		Q		T			P _f	P _n		
							P _t			

FIGURE A.22.3.2(c) Hydraulic Calculations.

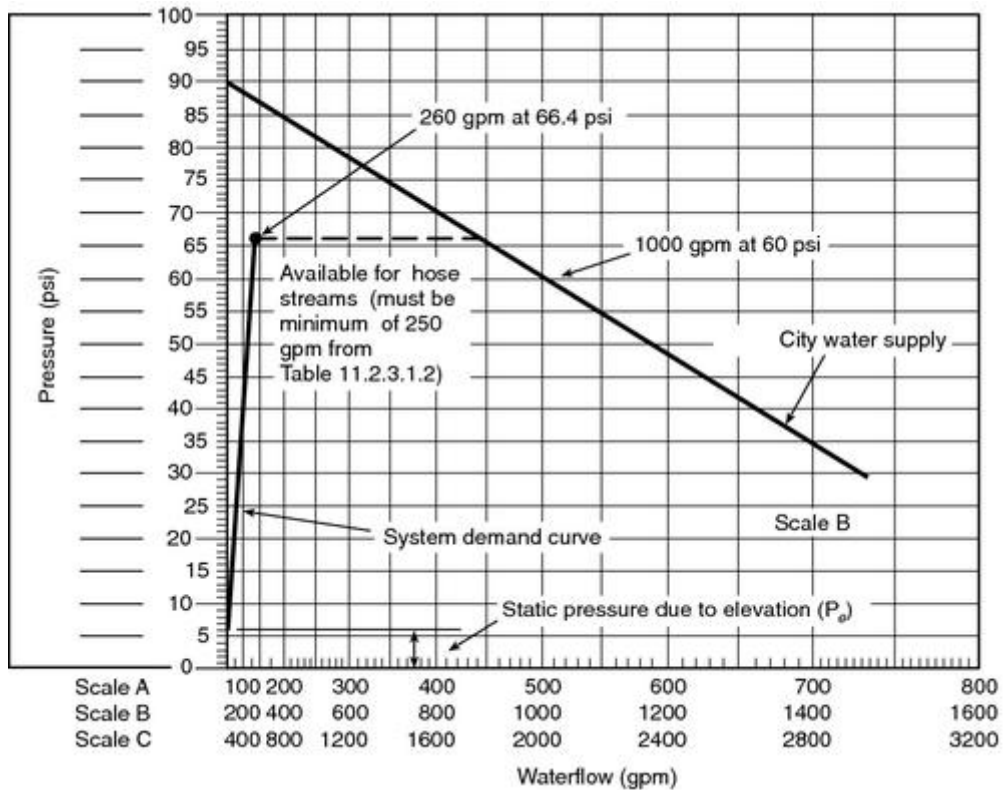

FIGURE A.22.3.2(d) Hydraulic Graph.

A.22.3.3 See Figure A.22.3.3.

Contract no. _____

Sheet no. _____ of _____

Name and location _____

Reference	Nozzle type and location	Flow in gpm (L/min)	Pipe size (in.)	Fitting and devices	Pipe equivalent length	Friction loss psi/ft (bar/m)	Required psi (bar)	Normal Pressure	Notes
	q				length		P_t	P_t	
					fitting		P_f	P_v	
	Q				total		P_o	P_n	
	q				length		P_t	P_t	
					fitting		P_f	P_v	
	Q				total		P_o	P_n	
	q				length		P_t	P_t	
					fitting		P_f	P_v	
	Q				total		P_o	P_n	
	q				length		P_t	P_t	
					fitting		P_f	P_v	
	Q				total		P_o	P_n	
	q				length		P_t	P_t	
					fitting		P_f	P_v	
	Q				total		P_o	P_n	
	q				length		P_t	P_t	
					fitting		P_f	P_v	
	Q				total		P_o	P_n	
	q				length		P_t	P_t	
					fitting		P_f	P_v	
	Q				total		P_o	P_n	
	q				length		P_t	P_t	
					fitting		P_f	P_v	
	Q				total		P_o	P_n	
	q				length		P_t	P_t	
					fitting		P_f	P_v	
	Q				total		P_o	P_n	
	q				length		P_t	P_t	
					fitting		P_f	P_v	
	Q				total		P_o	P_n	
	q				length		P_t	P_t	
					fitting		P_f	P_v	
	Q				total		P_o	P_n	
	q				length		P_t	P_t	
					fitting		P_f	P_v	
	Q				total		P_o	P_n	
	q				length		P_t	P_t	
					fitting		P_f	P_v	
	Q				total		P_o	P_n	

P_t : total pressure. P_f : friction loss pressure. P_v : velocity pressure. P_o : elevation pressure.

FIGURE A.22.3.3 Sample Worksheet.

A.22.3.3(15) See Figure A.22.3.3(15).

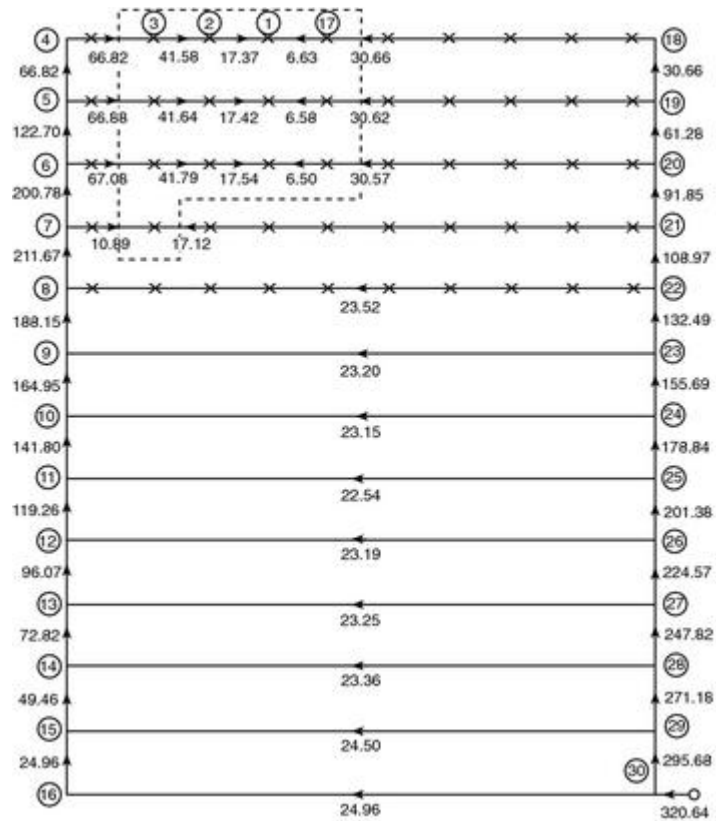

FIGURE A.22.3.3(15) Example of Hydraulically Remote Area — Grid System.

A.22.3.4 See Figure A.22.3.4.

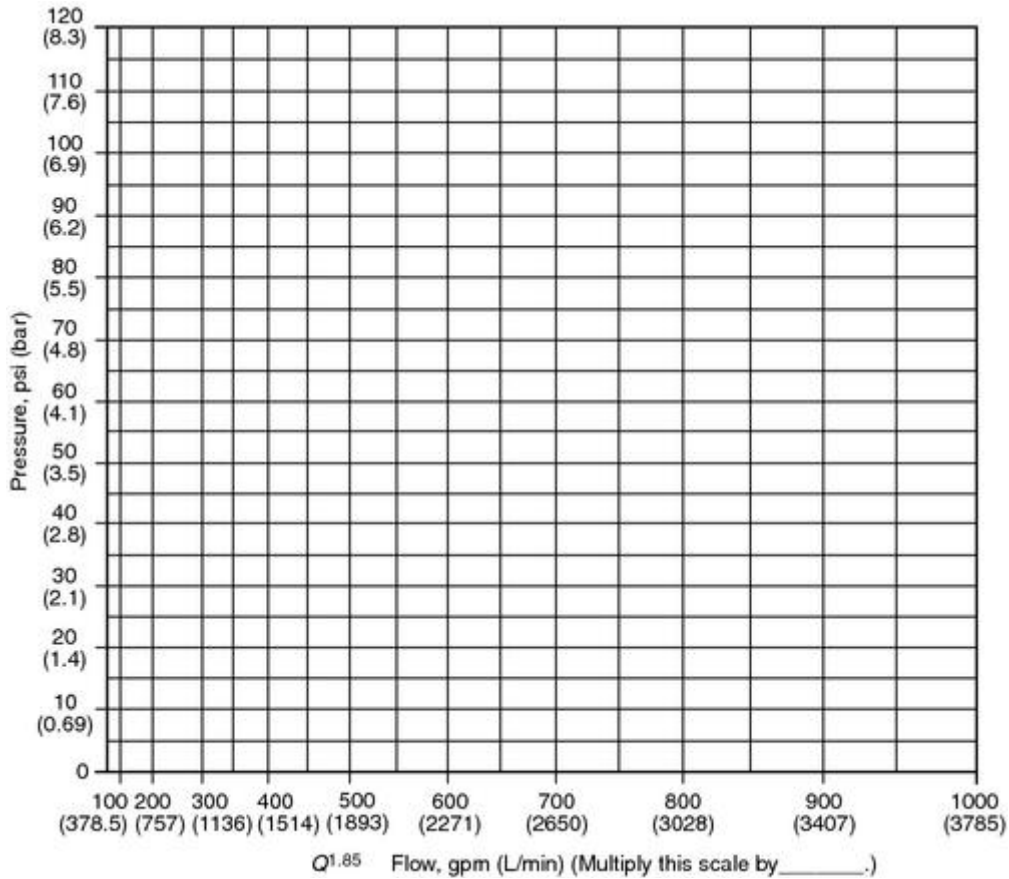
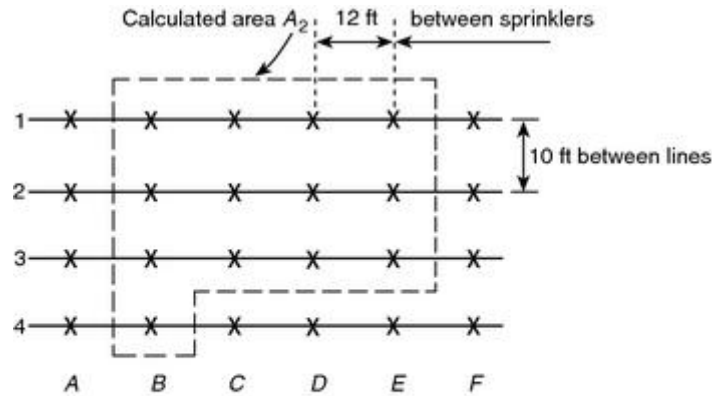

FIGURE A.22.3.4 Sample Graph Sheet.

A.22.3.5.1 Additional data may be added to any of the forms, provided that the format and order of the original information shown in Figure 22.3.5.1(a), Figure 22.3.5.1(b), Figure 22.3.5.1(c), and Figure 22.3.5.1(d) is followed.

A.22.4.1 When additional sprinkler piping is added to an existing system, the existing piping does not have to be increased in size to compensate for the additional sprinklers, provided the new work is calculated and the calculations include that portion of the existing system that can be required to carry water to the new work. It is not necessary to restrict the water velocity when determining friction losses using the Hazen–Williams formula.

A.22.4.4 See Figure A.22.4.4.



Notes:

1. For gridded systems, the extra sprinkler (or sprinklers) on branch line 4 can be placed in any adjacent location from B to E at the designer's option.
2. For tree and looped systems, the extra sprinkler on line 4 should be placed closest to the cross main.

Assume a remote area of 1500 ft² with sprinkler coverage of 120 ft²

$$\begin{aligned}
 \text{Total sprinklers to calculate} &= \frac{\text{Design area}}{\text{Area per sprinkler}} \\
 &= \frac{1500}{120} = 12.5, \text{ calculate } 13
 \end{aligned}$$

$$\text{Number of sprinklers on branch line} = \frac{1.2\sqrt{A}}{S}$$

Where:

A = design area

S = distance between sprinklers on branch line

$$\text{Number of sprinklers on branch line} = \frac{1.2\sqrt{1500}}{12} = 3.87$$

For SI units, 1 ft = 0.3048 m; 1 ft² = 0.0929 m².

FIGURE A.22.4.4 Example of Determining the Number of Sprinklers to Be Calculated.

A.22.4.4.1 See Figure A.22.4.4.1(a) and Figure A.22.4.4.1(b).

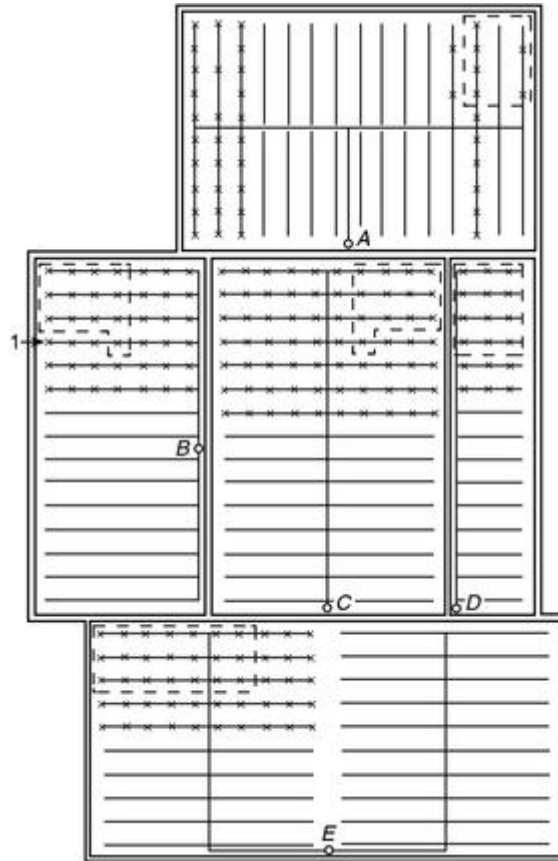

1 This sprinkler is not in the selected area of operation.

FIGURE A.22.4.4.1(a) Example of Hydraulically Most Demanding Area.

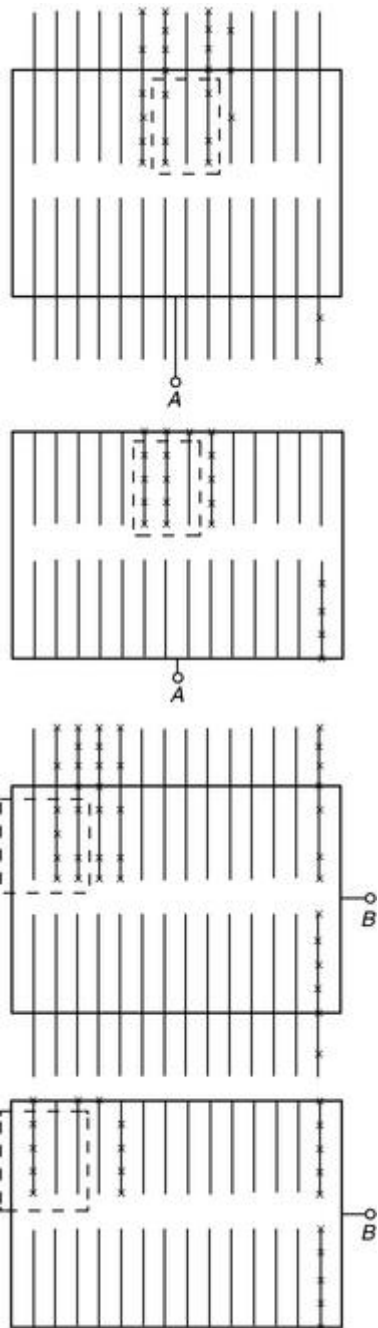

FIGURE A.22.4.4.1(b) Example of Hydraulically Most Demanding Area.

A.22.4.4.4 See Figure A.22.4.4.4.

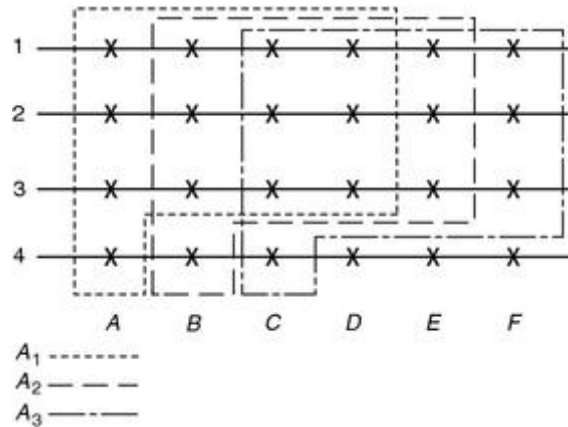

FIGURE A.22.4.4.4 Example of Determining the Most Remote Area for a Gridded System.

A.22.4.4.4.2 The sprinkler flow in a small room cannot be eliminated where the quick-response reduction has taken the design area below 1500 ft² (139 m²).

A.22.4.4.5.1 Published K factors are based upon water at ambient conditions and need to be modified to address different fluid properties. Additionally, See Figure A.22.4.4.5.1 for a Moody diagram and Table A.22.4.4.5.1 for ϵ -factors that correspond to Hazen–Williams C factors.

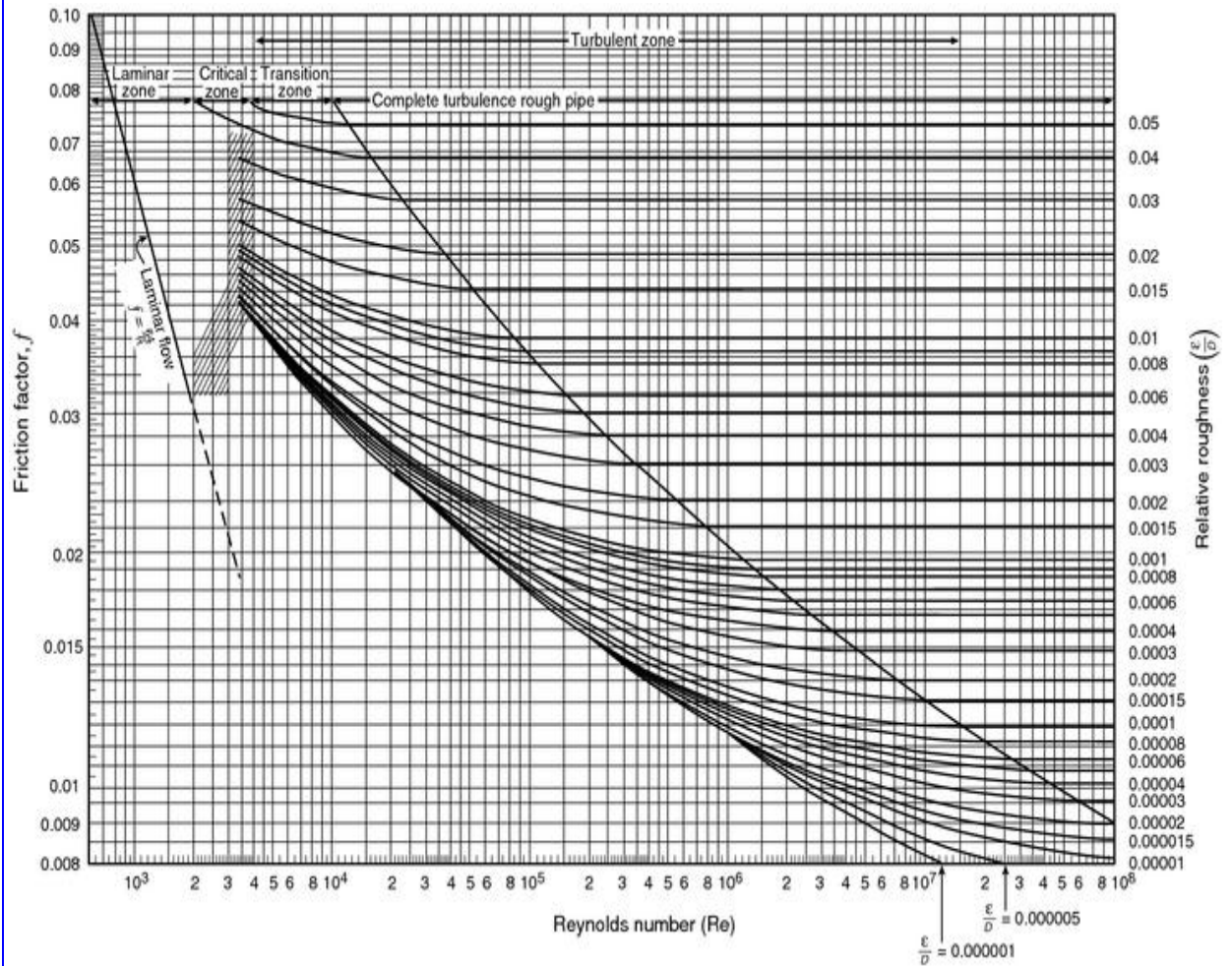

FIGURE A.22.4.4.5.1 Moody Diagram.

Table A.22.4.4.5.1 Suggested ϵ -Factor for Aged Pipe

Pipe	Hazen-Williams C Factor	ϵ -Factor (in.)
Steel (new)	143	0.0018
Steel	120	0.004
Steel	100	0.015
Copper	150	0.000084
Plastic	150	0.000084

For SI units, 1 in. = 25.4 mm.

A.22.4.4.5.3 See Figure A.22.4.4.5.3.

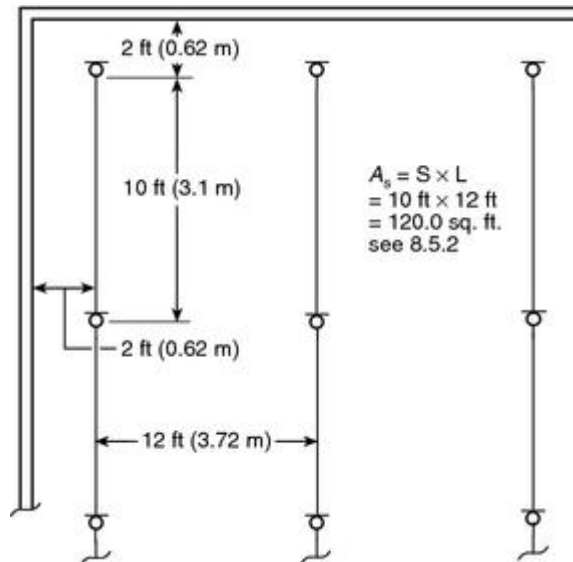

FIGURE A.22.4.4.5.3 Sprinkler Spacing.

A.22.4.4.5.5 This subsection assumes a ceiling constructed so as to reasonably ensure that a fire on one side of the ceiling will operate sprinklers on one side only. Where a ceiling is sufficiently open, or of such construction that operation of sprinklers above and below the ceiling can be anticipated, the operation of such additional sprinklers should be considered in the calculations.

A.22.4.4.5.6 Where the slope is parallel with the branch lines, the area per sprinkler for hydraulic calculation purposes would be found as

$$A_s = S' \times L$$

where:

$$S' = (\cos \theta)S$$

θ = the angle of the slope

S = the distance between sprinklers on the branch line per 8.5.2.1.2

See Figure A.22.4.4.5.6.

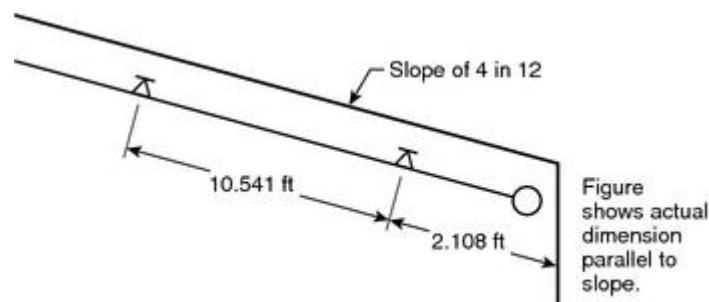

Calculation floor area = 10 ft x 12 ft (See Figure A.14.4.4.5.3)

FIGURE A.22.4.4.5.6 Determination of Floor Area Under Sloped Ceiling/Roof.

A.22.4.4.6 When it is not obvious by comparison that the design selected is the hydraulically most remote, additional calculations should be submitted. The most distant area is not necessarily the hydraulically most remote.

A.22.4.4.8 The use of sprinklers with differing orifice sizes in situations where different protection areas are needed is not considered balancing. An example would be a room that could be protected with sprinklers having different orifice size in closet, foyer, and room areas. However, this procedure introduces difficulties when restoring a system to service after operation since it is not always clear which sprinklers go where.

A.22.4.4.9 Where the normal pressure (P_n) is used to calculate the flow from an orifice, the following assumptions should be used:

- (1) At any flowing outlet along a pipe, except the end outlet, only the normal pressure (P_n) can act on the outlet. At the end outlet, the total pressure (P_t) can act. The following should be considered end outlets:
 - (a) The last flowing sprinkler on a dead-end branch line
 - (b) The last flowing branch line on a dead-end cross main
 - (c) Any sprinkler where a flow split occurs on a gridded branch line
 - (d) Any branch line where a flow split occurs on a looped system
- (2) At any flowing outlet along a pipe, except the end outlet, the pressure acting to cause flow from the outlet is equal to the total pressure (P_t) minus the velocity pressure (P_v) on the upstream (supply) side.
- (3) To find the normal pressure (P_n) at any flowing outlet, except the end outlet, assume a flow from the outlet in question and determine the velocity pressure (P_v) for the total flow on the upstream side. Because normal pressure (P_n) equals total pressure (P_t) minus velocity pressure (P_v), the value of the normal pressure (P_n) so found should result in an outlet flow approximately equal to the assumed flow; if not, a new value should be assumed, and the calculations should be repeated.

A.22.5.1 The demonstrated effectiveness of pipe schedule systems is limited to their use with ½ in. (13 mm) orifice sprinklers. The use of other size orifices can require hydraulic calculations to prove their ability to deliver the required amount of water within the available water supply.

A.22.5.1.4 Where the construction or conditions introduce unusually long runs of pipe or many angles in risers or feed or cross mains, an increase in pipe size over that called for in the schedules can be required to compensate for increased friction losses.

A.22.5.2.6 For example, a 2½ in. (64 mm) steel pipe, which is permitted to supply 30 sprinklers, can supply a total of 50 sprinklers where not more than 30 sprinklers are above or below a ceiling.

A.22.5.3.9 For example, a 3 in. (76 mm) steel pipe, which is permitted to supply 40

sprinklers in an ordinary hazard area, can supply a total of 60 sprinklers where not more than 40 sprinklers protect the occupied space below the ceiling.

A.22.5.4 The piping schedule shown in Table A.22.5.4 is reprinted only as a guide for existing systems. New systems for extra hazard occupancies should be hydraulically calculated as required in 22.5.4.

Table A.22.5.4 Extra Hazard Pipe Schedule

Steel		Copper	
1 in.	1 sprinkler	1 in.	1 sprinkler
1¼ in.	2 sprinklers	1¼ in.	2 sprinklers
1½ in.	5 sprinklers	1½ in.	5 sprinklers
2 in.	8 sprinklers	2 in.	8 sprinklers
2½ in.	15 sprinklers	2½ in.	20 sprinklers
3 in.	27 sprinklers	3 in.	30 sprinklers
3½ in.	40 sprinklers	3½ in.	45 sprinklers
4 in.	55 sprinklers	4 in.	65 sprinklers
5 in.	90 sprinklers	5 in.	100 sprinklers
6 in.	150 sprinklers	6 in.	170 sprinklers

For SI units, 1 in. = 25.4 mm.

A.22.7 In the design of an exposure protection system, the flow rate from window and cornice sprinklers is shown in Table 22.7.1. The flow rates are based on the guide numbers selected from Table 4.3.7.3 of NFPA 80A, *Recommended Practice for Protection of Buildings from Exterior Fire Exposures*, which can be utilized as the basis for determining whether exposure protection is needed.

A.23.1.3.2 When a single main less than 6 in. (152 mm) in diameter serves both domestic and fire systems, the domestic demand should be added to the hydraulic calculations for the fire system at the point of connection unless provisions have been made to isolate the domestic demand.

A.23.1.5 Evaluation of the water supply and environmental conditions does not necessarily require a water sample analysis by a laboratory. Instead, general knowledge of the long-term condition of sprinkler systems with similar piping materials in similar environments on the same water supply can be a sufficient evaluation.

There are several options to address the effects of MIC on sprinkler systems. Some types of sprinkler pipe such as CPVC have not shown to be affected by MIC. Other types of pipe are being manufactured with a biofilm that resists the effects of MIC.

Where water supplies are treated with biocides, evaluation of the effects of the biocide on sprinkler system components (pipe, fittings, sprinklers, gaskets, valves, and seals) is just as important as evaluating the effect the biocide has on the organisms. Where water treatment is selected as the method to deal with MIC, all water entering the system during testing or flushing needs to be treated so that the organisms do not get a chance to establish themselves.

Since all of the conditions that can affect the growth of MIC are unknown, a plan to sample randomly selected interior positions in the system can be effective. The frequency and location of the interior inspections will depend on the extent of the known MIC problem with the same water supply and similar environmental conditions.

A.23.1.6.2 Where the system riser is close to an outside wall, underground fittings of proper length should be used in order to avoid pipe joints located in or under the wall. Where the connection passes through the foundation wall below grade, a 1 in. to 3 in. (25 mm to 76 mm) clearance should be provided around the pipe and the clear space filled with asphalt mastic or similar flexible waterproofing material.

A.23.1.7 Where water meters are in the supply lines to a sprinkler system, they should be rated to deliver the proper system demand. The amount of water supplied through a water meter varies with its size and type and might not provide the required demand, regardless of the water supply available.

A.23.1.8 Where connections are made from public waterworks systems, such systems should be guarded against possible contamination as follows (*see AWWA M14, Recommended Practice for Backflow Prevention and Cross Connection Control*):

- (1) For private fire service mains with direct connections from public waterworks mains only or with booster pumps installed in the connections from the street mains, no tanks or reservoirs, no physical connection from other water supplies, no antifreeze or other additives of any kind, and with all drains discharging to atmosphere, dry well, or other safe outlets, no backflow protection is recommended at the service connection.
- (2) For private fire service mains with direct connection from the public water supply main plus one or more of the following: elevated storage tanks or fire pumps taking suction from aboveground covered reservoirs or tanks (all storage facilities are filled or connected to public water only and the water in the tanks is to be maintained in a potable condition), an approved double check valve assembly is recommended.
- (3) For private fire service mains directly supplied from public mains with an auxiliary water supply such as a pond or river on or available to the premises and dedicated to fire department use; or for systems supplied from public mains and interconnected with auxiliary supplies, such as pumps taking suction from reservoirs exposed to contamination or rivers and ponds; driven wells, mills, or other industrial water systems; or for systems or portions of systems where antifreeze or other solutions are used, an approved reduced pressure zone-type backflow preventer is recommended.

A.23.2.1 Care should be taken in making water tests to be used in designing or evaluating the capability of sprinkler systems. The water supply tested should be representative of the supply that might be available at the time of a fire. For example, testing of public water supplies should be done at times of normal demand on the system. Public water supplies are likely to fluctuate widely from season to season and even within a 24-hour period. Allowance should be made for seasonal or daily fluctuations, for drought conditions, for possibility of interruption by flood, or for ice conditions in winter. Testing of water supplies also normally used for industrial use should be done while water is being drawn for industrial use. The

range of industrial-use demand should be taken into account. In special situations where the domestic water demand could significantly reduce the sprinkler water supply, an increase in the size of the pipe supplying both the domestic and sprinkler water can be justified.

Future changes in water supplies should be considered. For example, a large, established, urban supply is not likely to change greatly within a few years. However, the supply in a growing suburban industrial park might deteriorate quite rapidly as greater numbers of plants draw more water.

Dead-end mains should be avoided, if possible, by arranging for mains supplied from both directions. When private fire service mains are connected to dead-end public mains, each situation should be examined to determine if it is practical to request the water utility to loop the mains in order to obtain a more reliable supply.

Testing of Water Supply. To determine the value of public water as a supply for automatic sprinkler systems, it is generally necessary to make a flow test to determine how much water can be discharged at a residual pressure at a rate sufficient to give the required residual pressure under the roof (with the volume flow hydraulically translated to the base of the riser) — that is, a pressure head represented by the height of the building plus the required residual pressure.

The proper method of conducting this test is to use two hydrants in the vicinity of the property. The static pressure should be measured on the hydrant in front of or nearest to the property and the water allowed to flow from the hydrant next nearest the property, preferably the one farthest from the source of supply if the main is fed only one way. The residual pressure will be that indicated at the hydrant where water is not flowing.

Referring to Figure A.23.2.1, the method of conducting the flow tests is as follows:

- (1) Attach the gauge to the hydrant (*A*) and obtain static pressure.
- (2) Either attach a second gauge to the hydrant (*B*) or use the pitot tube at the outlet. Have hydrant (*B*) opened wide and read pressure at both hydrants.
- (3) Use the pressure at (*B*) to compute the gallons flowing and read the gauge on (*A*) to determine the residual pressure or that which will be available on the top line of sprinklers in the property.

Water pressure in pounds per square inch for a given height in feet equals height multiplied by 0.433.

In making flow tests, whether from hydrants or from nozzles attached to hose, always measure the size of the orifice. While hydrant outlets are usually 2½ in. (64 mm), they are sometimes smaller and occasionally larger. Underwriters Laboratories play pipe is 1⅞ in. (29 mm) and 1¾ in. (44 mm) with the tip removed, but occasionally nozzles will be 1 in. (25.4 mm) or 1¼ in. (33 mm), and with the tip removed the opening can be only 1½ in. (38 mm).

The pitot tube should be held approximately one-half the diameter of the hydrant or nozzle opening away from the opening. It should be held in the center of the stream, except that in using hydrant outlets the stream should be explored to ascertain the average pressure.

For further information on water supply testing, see NFPA 291, *Recommended Practice for*
Copyright NFPA

Fire Flow Testing and Marking of Hydrants.

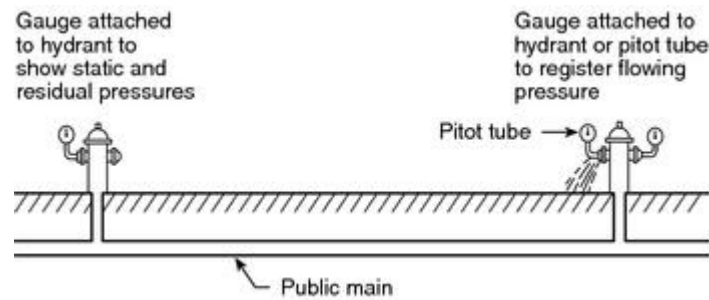

FIGURE A.23.2.1 Method of Conducting Flow Tests.

A.23.2.2 An automatically controlled vertical turbine pump taking suction from a reservoir, pond, lake, river, or well complies with 23.2.2.

See sections dealing with sprinkler equipment supervisory and waterflow alarm services in *NFPA 72, National Fire Alarm Code*.

A.23.2.3.3 For pipe schedule systems, the air pressure to be carried and the proper proportion of air in the tank can be determined from the following formulas where:

P = air pressure carried in pressure tank

A = proportion of air in tank

H = height of highest sprinkler above tank bottom

When the tank is placed above the highest sprinkler, use the following formula:

$$P = \frac{30}{A} - 15$$

If $A = \frac{1}{3}$, then $P = 90 - 15 = 75$ lb psi

If $A = \frac{1}{2}$, then $P = 60 - 15 = 45$ lb psi

If $A = \frac{2}{3}$, then $P = 45 - 15 = 30$ lb psi

When the tank is below the level of the highest sprinkler, use the following formula:

$$P = \frac{30}{A} - 15 + \frac{0.434H}{A}$$

If $A = \frac{1}{3}$, then $P = 75 + 1.30H$

If $A = \frac{1}{2}$, then $P = 45 + 0.87H$

If $A = \frac{2}{3}$, then $P = 30 + 0.65H$

The preceding respective air pressures are calculated to ensure that the last water will leave the tank at a pressure of 15 psi (1 bar) when the base of the tank is on a level with the highest sprinkler or at such additional pressure as is equivalent to a head corresponding to the distance between the base of the tank and the highest sprinkler when the latter is above

the tank.

For hydraulically calculated systems, the following formula should be used to determine the tank pressure and ratio of air to water:

$$P_i = \frac{P_j + 15}{A} - 15$$

where:

P_i = tank pressure

P_j = pressure required from hydraulic calculations

A = proportion of air

Example: Hydraulic calculations indicate 75 psi (5.2 bar) is required to supply the system. What tank pressure will be required?

$$P_i = \frac{75 + 15}{0.5} - 15$$
$$P_i = 180 - 15 = 165 \text{ psi}$$

For SI units, 1 ft = 0.3048 m; 1 psi = 0.0689 bar.

In this case, the tank would be filled with 50 percent air and 50 percent water, and the tank pressure would be 165 psi (11.4 bar). If the pressure is too high, the amount of air carried in the tank will have to be increased.

Pressure tanks should be located above the top level of sprinklers but can be located in the basement or elsewhere.

A.24.2.1 The use of noncombustible compressed gas to increase the pressure in a water-filled system is an acceptable test procedure.

A.24.2.1.9 Biocides and other chemicals which are approved and used for the prevention and mitigation of MIC, and which do not adversely affect the fire-fighting properties of the water or the performance of the fire sprinkler system components are not prohibited.

A.24.2.1.13 Valves isolating the section to be tested might not be “drop-tight.” When such leakage is suspected, test blanks of the type required in 24.2.1.13 should be used in a manner that includes the valve in the section being tested.

A.24.2.3.2 When the acceptance test is being performed during freezing conditions, a partial flow trip test should be conducted at that time and the full flow trip test specified should be conducted as soon as conditions permit.

A.24.2.3.2.2 The test criteria are based on the first evidence of waterflow to the inspector's test. Air can be mixed with the water for several minutes until the air is completely flushed from the system.

A.24.5 See Figure A.24.5.

This system as shown on company
print no dated
for
at contract no
is designed to discharge at a rate of gpm/ft²
(L/min/m²) of floor area over a maximum area of
ft² (m²) when supplied with water at a rate of
gpm (L/min) at psi (bar) at the base of the riser.
Hose stream allowance of gpm (L/min)
is included in the above.
Occupancy classification
Commodity classification
Maximum storage height

FIGURE A.24.5 Sample Nameplate.

A.24.6 While the information on this sign is useful during an inspection, such use should not be considered a hazard assessment based on the requirements of this standard. (See *Figure A.24.6.*)

SPRINKLER SYSTEM — GENERAL INFORMATION			
for			

High-piled storage	<input type="checkbox"/> Yes	<input type="checkbox"/> No	Date: _____
Rack storage:	<input type="checkbox"/> Yes	<input type="checkbox"/> No	Flow test data:
Commodity class: _____	Static: _____ psi		
Max. storage ht _____ ft	Resid: _____ psi		
Aisle width (min.) _____ ft	Flow: _____ gpm		
Encapsulation	<input type="checkbox"/> Yes	<input type="checkbox"/> No	Pitot: _____ psi
Solid shelving:	<input type="checkbox"/> Yes	<input type="checkbox"/> No	Date: _____
Flammable/ combustible liquids:	<input type="checkbox"/> Yes	<input type="checkbox"/> No	Location: _____
Other storage:	<input type="checkbox"/> Yes	<input type="checkbox"/> No	_____

Hazardous materials:	<input type="checkbox"/> Yes	<input type="checkbox"/> No	Location of aux/low point drains:
Idle pallets:	<input type="checkbox"/> Yes	<input type="checkbox"/> No	_____
Antifreeze systems	<input type="checkbox"/> Yes	<input type="checkbox"/> No	_____
Location: _____	Original main drain test results:		
Dry or aux systems	<input type="checkbox"/> Yes	<input type="checkbox"/> No	Static: _____ psi
Location: _____	Residual: _____ psi		

Name of contractor or designer:			

Address: _____			
Phone: _____			

FIGURE A.24.6 Sprinkler System General Information.

A.25.1.3(4) The backbone of the fire protection philosophy for U.S. flagged vessels and passenger vessels that trade internationally is limiting a fire to the compartment of origin by passive means. Materials that do not withstand a 1-hour fire exposure when tested in accordance with ASTM E 119 are considered “heat sensitive.” [See Figure A.25.1.3(4).]

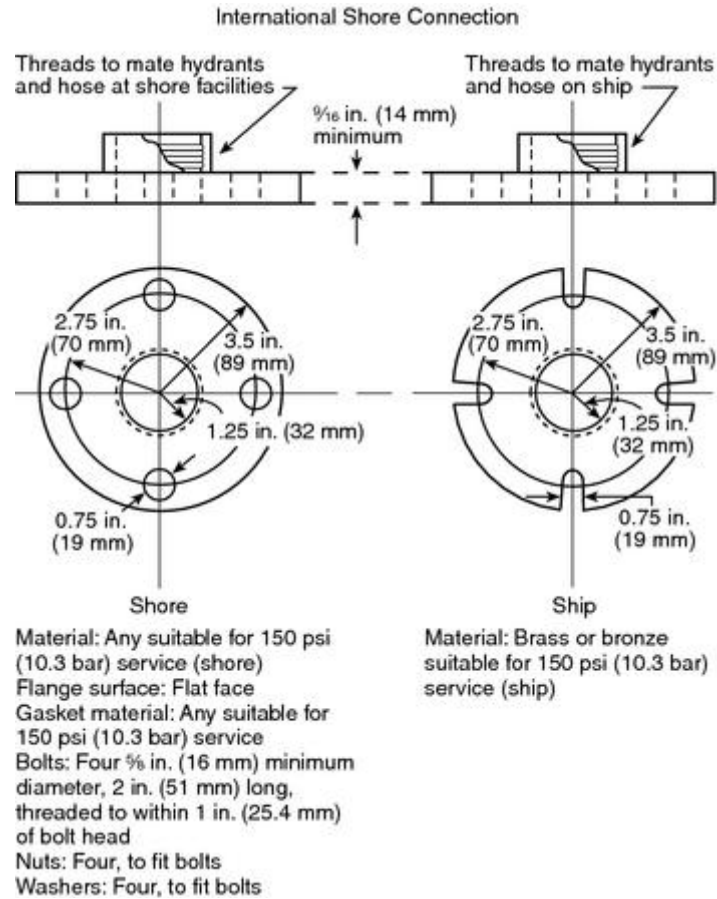

FIGURE A.25.1.3(4) International Shore Fire Connection.

A.25.1.3(8) Some types of sprinkler systems can closely resemble marine systems, such as a system installed on a floating structure that has a permanent water supply connection to a public main. For these types of systems, judgment should be used in determining if certain aspects of Chapter 25 are applicable.

A.25.1.3(9) A marine thermal barrier is typically referred to as a B-15 boundary.

A.25.1.4 In addition to the examples provided in A.5.1, Table A.25.1.4 provides additional examples of occupancy definitions of typical shipboard spaces.

Table A.25.1.4 Examples of Shipboard Space Occupancy Classification

Occupancy Type	Space Types Included		Ex
	CFR ^a	SOLAS ^b	
Light hazard	1 ^c , 2, 3, 4, 5, 6, 7, 8 ^d , 13	1 ^c , 2, 3, 4, 5, 6, 7, 8, 9	Accommodation spaces Small pantries
Ordinary hazard (Group 1)	8 ^d , 9 ^d	12, 13 ^d	Galleys Storage areas Sales shops Laundries Pantries with signs

Table A.25.1.4 Examples of Shipboard Space Occupancy Classification

Occupancy Type	Space Types Included		Ex
	CFR ^a	SOLAS ^b	
Ordinary hazard (Group 2)	9 ^d , 11 ^d	12 ^d , 13 ^d	Sales shops Storage areas Stages (with sets) Machine shops
Extra hazard (Group 1)	1, 9 ^d , 10, 11 ^d	1, 12 ^d , 13 ^d	Auxiliary machine combustible liquid Steering rooms — fluid in use ^e
Extra hazard (Group 2)	1, 9 ^d , 10, 11 ^d	1, 12 ^d , 13 ^d	Auxiliary machine liquids ^e Machinery spaces ^e

^a Space type designations are given in 46 CFR 72.05-5.

^b Space type designations are given in the *International Convention for the Safety of Life at Sea, 1974* (SOLA; regulations II-2/3 and II-2/26.

^cPrimarily for accommodation-type control stations, such as the wheel house, which would not include generat similar-type spaces.

^dDepends on storage type, quantity, and height and distance below sprinkler.

^e Automatic sprinklers typically will not be the primary means of protection in these areas; total flooding syste

The classifications in Table A.25.1.4 are not meant to be applied without giving consideration to the definition of each occupancy hazard given in the standard. Table A.25.1.4 is general guidance for classification of typical spaces. Where a space is outfitted such that the occupancy definitions indicate that another classification would be more appropriate, the most representative and most demanding occupancy classification should be used. For example, it would certainly be possible to outfit a stateroom to require upgrading the occupancy to ordinary hazard, Group 1.

When a vessel undergoes modifications, alterations, or service changes that significantly affect the fire risk of the occupancy of one or more compartments, the occupancy classification should be reevaluated to determine if it has changed.

A.25.1.5 Experience has shown that structures that are partially sprinklered can be overrun by well-developed fires originating in unsprinklered areas. Therefore, the entire vessel should be sprinklered whenever sprinkler systems are considered.

A.25.2.1 Sprinklers with a nominal K-factor of 2.8 or less coupled with a system strainer minimize the potential for clogging.

A.25.2.2 Where a marine thermal barrier is penetrated, limiting the opening around the sprinkler pipe to $\frac{1}{16}$ in. (1.6 mm) is considered as meeting this requirement.

A.25.2.4.1 When nonferrous materials are used, consideration should be given to protecting against galvanic corrosion where the nonferrous materials connect to steel pipe. Consideration should also be given to protection against galvanic corrosion from pipe

hangers in areas of high humidity.

The piping between the sea chest and the sprinkler zone valves are likely to see the frequent flow of saltwater when testing. Sprinkler zone piping will rarely, if ever, be exposed to saltwater. In such an event, NFPA 25, *Standard for the Inspection, Testing, and Maintenance of Water-Based Fire Protection Systems*, requires flushing of the piping. Even if the piping is not flushed, the saltwater will not be replenished and will lose oxygen content in fairly short order.

Even if galvanized, the failure from corrosion from the interior of the pipe is likely to be at all threaded connections, welded assembly connections, and where brass sprinklers thread into ferrous pipe. Only hot dipped galvanized after fabrication of assembly (as opposed to simply hot dipped galvanized pipe and fittings) will protect against some of those failures. Hot dipped galvanized after fabrication of assembly is practical from the sea chest to the sprinkler manifold where spaces are open and pipe is relatively large and uses flanged takedown joints instead of threaded unions. Hot dipped galvanized after fabrication of assembly is not practical in the sprinkler zone pipe where it is mainly field fit.

A.25.2.5.1 When designing supports, the selection and spacing of pipe supports should take into account the pipe dimensions, mechanical and physical properties of piping materials and supports, operating temperature, thermal expansion effects, external loads, thrust forces, vibration, maximum accelerations, differential motions to which the system might be subjected, and the type of support.

The route of the vessel is intended to be descriptive of its usual operating area. For example, expected motion of the system on an ocean vessel is expected to be considerably greater than the motion of a vessel that operates on a river. A vessel that operates within the confines of any of the Great Lakes is expected to subject the system pipe to greater motion than would a vessel that operates on a lake such as Lake Tahoe.

It is recommended that the designer review the requirements for automatic sprinkler systems that are subject to earthquakes. While it is obvious that shipboard motions and accelerations differ from those that occur during an earthquake, the general principle of protecting the piping system against damage applies. Individual hanger design, however, will be very similar.

Earthquake protection does not apply to ships; however, motions are similar to those that a ship will experience in a seaway. The design principles discussed in this section should be used as a guide for shipboard system design.

A.25.2.5.3 Use of heat-sensitive materials for pipe hangers and supports might be desirable in some cases. Where heat-sensitive materials are used, the hangers and supports should be adequately protected by either the direct application of insulation or installation behind a marine thermal barrier. Insulation materials applied directly to hangers should be insulated in accordance with the method provided in Society of Naval Architects and Marine Engineers Technical Research Bulletin 2-21, "Aluminum Fire Protection Guidelines."

A.25.2.5.4 Consideration should be given to increasing the size of rods and U-hooks as necessary, to account for service and operational loading, including ship motion and

vibrations.

A.25.2.6.1 Shipboard installations will normally require more than one valve per water supply. Locking valves in the open position is not an acceptable substitute for the requirement of 25.2.6.1 but can be done in addition to the supervision requirement.

A.25.2.7.1 International Shore Connections are portable universal couplings that permit connections of shipboard sprinkler or firemain systems between one ship and another or between a shore facility and a ship. Both the ship and the shore facility are expected to have an international shore connection fitting such that in an emergency they can be attached to their respective fire hoses and bolted together to permit charging the ship's system. It must be portable to accommodate hose-to-hose connection and allow assistance from any position.

Installation of an additional fire boat connection might be required on-board vessels whose route is such that regular access to fire boats is possible. An additional fire boat connection might not be necessary where fire boats are equipped to connect to the regular fire department connection. (*See A.25.2.7.7.*)

A.25.2.7.7 Selection of the pipe thread for the fire department connection should be done very carefully. It is recommended that a 2½ in. (63.5 mm) siamese connection with National Standard Hose Thread be used since a majority of fire department hose lines will be compatible with this thread. However, it must be noted that some fire jurisdictions might not be compatible with a connection of this type. Serious consideration should be given to the vessel's typical operating area. Precautions and planning should avert the possibility of the vessel being forced ashore by fire at a location where the fire department equipment is not compatible with this connection. Carriage of extra fittings and pre-voyage arrangements with all applicable jurisdictions should be considered. The international shore connection is required to ensure that all vessels fitted with sprinkler systems have at least one type of common connection.

A.25.3.1 Special consideration should be given to the installation of relief valves in all wet pipe systems. Ambient ship temperatures can vary greatly depending on operating environment, duration of voyage, and failure of climate control systems.

A.25.4.2 Areas fitted primarily with multiple staterooms and corridors should be considered sleeping accommodation areas.

A.25.4.4 If combustibles are present such that they constitute a threat, the space should be sprinklered. One example would be the presence of large bundles of unsheathed computer or electrical cable. Typical amounts of lighting or control cabling should not be considered to constitute a fire threat.

A.25.4.10.1(4) Because of its melting point, brazing would be considered heat sensitive. The criterion of this paragraph is intended to permit brazed joints without requiring that they be installed behind a marine thermal barrier, while maintaining the fire endurance as stated in 25.4.10.1 under reasonably foreseeable failure modes.

A.25.4.12.1 While not required, a dual annunciator alarm panel system is recommended. One panel should show the piping system layout and indicate status of zone valves, tank

pressures, water supply valves, pump operation, and so forth. The second panel should show the vessel's general arrangement and indicate status of waterflow (i.e., fire location) alarms.

A.25.5.2 For example, a design area of 1500 ft² (139.3 m²) is used to design a sprinkler system for an unobstructed light hazard occupancy. In this case, the system must supply at least seven sprinklers that are installed within that area. If eight sprinklers are installed to protect windows within this design area, the water demand of these sprinklers is added to the total water demand. Thus, 15 sprinklers must be supplied by this system.

A.25.5.3 Hose stream flow need not be added to the water demand. The water supply for fire streams is supplied by separate fire pump(s) that supply the vessel's fire main.

A.25.6.4 In vessels, the elevation of sprinklers with respect to the water supply varies as the vessel heels to either side or trims by the bow or stern. The water demand requirements can be increased or decreased under these conditions. This requirement aligns the operational parameters of this safety system with that required for other machinery vital to the safety of the vessel.

A.25.7.2.7 The purpose of this requirement is to ensure that the pressure tank air supply will not keep the tank “fully” pressurized while water is expelled, thus preventing pump actuation.

A.25.7.3.3 NFPA 20, *Standard for the Installation of Stationary Pumps for Fire Protection*, requires that fire pumps furnish not less than 150 percent of their rated capacity at not less than 65 percent of their rated heat. The intention of the requirement of 25.7.3.3 is to limit designers to 120 percent of the rated capacity of the pump to provide an additional factor of safety for marine systems.

A.25.7.3.12.2(1) Pumps should not be located within the same compartment. However, where this is not reasonable or practical, special attention should be given to protecting pumps such that a single failure will not render the sprinkler system inoperative. *[See Figure A.25.7.3.12.2(1).]*

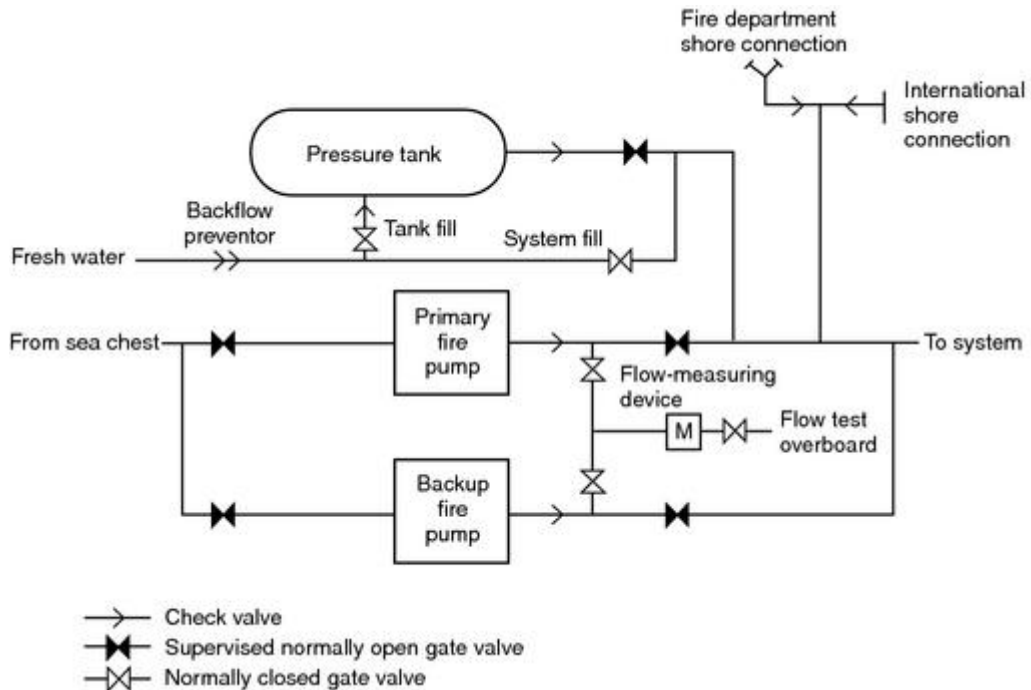

FIGURE A.25.7.3.12.2(1) Abbreviated Example of a Dual Fire Pump Water Supply.

A.25.7.3.13 See Figure A.25.7.3.13.

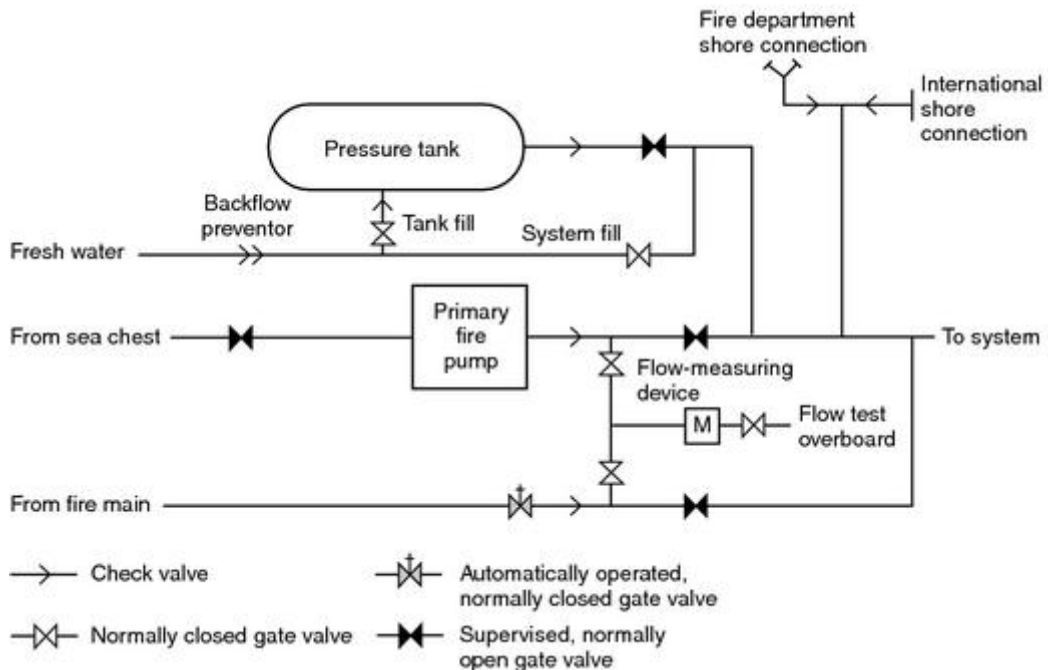

FIGURE A.25.7.3.13 Abbreviated Example of a Water Supply with Fire Pump Backup.

A.25.7.4.6 This procedure should be used to qualify each water supply to which the vessel is to be attached. For example, this might require testing of multiple hydrants or connections in the same mooring area. The pressure loss effect of the hose or piping leading from the

water supply to the ship should also be considered when qualifying each hydrant.

A.26.1 Impairments. Before shutting off a section of the fire service system to make sprinkler system connections, notify the authority having jurisdiction, plan the work carefully, and assemble all materials to enable completion in the shortest possible time. Work started on connections should be completed without interruption, and protection should be restored as promptly as possible. During the impairment, provide emergency hose lines and extinguishers and maintain extra watch service in the areas affected.

When changes involve shutting off water from any considerable number of sprinklers for more than a few hours, temporary water supply connections should be made to sprinkler systems so that reasonable protection can be maintained. In adding to old systems or revamping them, protection should be restored each night so far as possible. The members of the private fire brigade as well as public fire departments should be notified as to conditions.

Maintenance Schedule. The items shown in Table A.26.1 should be checked on a routine basis.

Table A.26.1 Maintenance Schedule

Parts	Activity	Frequency
Flushing piping	Test	5 years
Fire department connections	Inspection	Monthly
Control valves	Inspection	Weekly — sealed
	Inspection	Monthly — locked
	Inspection	Monthly — tamper switch
	Maintenance	Yearly
Main drain	Flow test	Quarterly — annual
Open sprinklers	Test	Annually
Pressure gauge	Calibration test	
Sprinklers	Test	50 years
Sprinklers — high-temperature	Test	5 years
Sprinklers — residential	Test	20 years
Waterflow alarms	Test	Quarterly
Preaction/deluge detection system	Test	Semiannually
Preaction/deluge systems	Test	Annually
Antifreeze solution	Test	Annually
Cold weather valves	Open and close valves	Fall, close; spring, open
Dry/preaction/deluge systems		
Air pressure and water pressure	Inspection	Weekly
Enclosure	Inspection	Daily — cold weather
Priming water level	Inspection	Quarterly
Low-point drains	Test	Fall
Dry pipe valves	Trip test	Annually — spring

Table A.26.1 Maintenance Schedule

Parts	Activity	Frequency
Dry pipe valves	Full flow trip	3 years — spring
Quick-opening devices	Test	Semiannually

Annex B Miscellaneous Topics

This annex is not a part of the requirements of this NFPA document but is included for informational purposes only.

B.1

Figure B.1 shows acceptable methods for interconnection of the fire protection and domestic water supply.

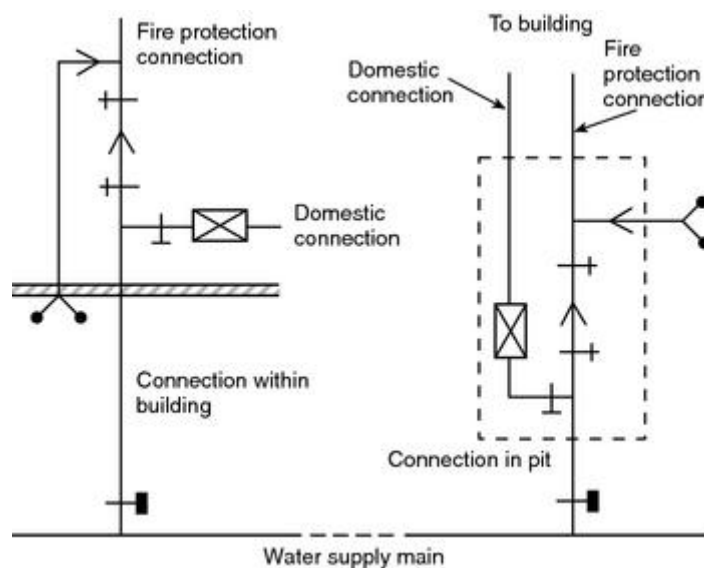

FIGURE B.1 Permitted Arrangements Between the Fire Protection Water Supply and the Domestic Water Supply.

B.2 Sprinkler System Performance Criteria.

B.2.1 Sprinkler system performance criteria have been based on test data. The factors of safety are generally small, are not definitive, and can depend on expected (but not guaranteed) inherent characteristics of the sprinkler systems involved. These inherent factors of safety consist of the following:

- (1) The flow-declining pressure characteristic of sprinkler systems whereby the initial operating sprinklers discharge at a higher flow than with all sprinklers operating within the designated area.

- (2) The flow-declining pressure characteristic of water supplies, which is particularly steep where fire pumps are the water source. This characteristic similarly produces higher than design discharge at the initially operating sprinklers.

The user of these standards can elect an additional factor of safety if the inherent factors are not considered adequate.

B.2.1.1 Performance-specified sprinkler systems, as opposed to scheduled systems, can be designed to take advantage of multiple loops or gridded configurations. Such configurations result in minimum line losses at expanded sprinkler spacing, in contrast to the older tree-type configurations, where advantage cannot be taken of multiple path flows.

Where the water supply characteristics are relatively flat with pressures being only slightly above the required sprinkler pressure at the spacing selected, gridded systems with piping designed for minimal economic line losses can all but eliminate the inherent flow-declining pressure characteristic generally assumed to exist in sprinkler systems. In contrast, the economic design of a tree-type system would likely favor a system design with closer sprinkler spacing and greater line losses, demonstrating the inherent flow-declining pressure characteristic of the piping system.

Elements that enter into the design of sprinkler systems include the following:

- (1) Selection of density and area of application
- (2) Geometry of the area of application (remote area)
- (3) Permitted pressure range at sprinklers
- (4) Determination of the water supply available
- (5) Ability to predict expected performance from calculated performance
- (6) Future upgrading of system performance
- (7) Size of sprinkler systems

In developing sprinkler specifications, each of these elements needs to be considered individually. The most conservative design should be based on the application of the most stringent conditions for each of the elements.

B.2.1.2 Selection of Density and Area of Application. Specifications for density and area of application are developed from NFPA standards and other standards. It is desirable to specify densities rounded upward to the nearest 0.005 gpm/ft² (0.2 mm/min).

Prudent design should consider reasonable-to-expect variations in occupancy. This design would include not only variations in type of occupancy but also, in the case of warehousing, the anticipated future range of materials to be stored, clearances, types of arrays, packaging, pile height, and pile stability, as well as other factors.

Design should also consider some degree of adversity at the time of a fire. To take this into account, the density and/or area of application can be increased. Another way is to use a dual-performance specification where, in addition to the normal primary specifications, a secondary density and area of application are specified. The objective of such a selection is to

control the declining pressure-flow characteristic of the sprinkler system beyond the primary design flow.

A case can be made for designing feed and cross mains to lower velocities than branch lines to achieve the same result as specifying a second density and area of application.

B.2.1.3 Geometry of the Area of Application (Remote Area). It is expected that, over any portion of the sprinkler system equivalent in size to the area of application, the system will achieve the minimum specified density for each sprinkler within that area.

Where a system is computer-designed, ideally the program should verify the entire system by shifting the area of application the equivalent of one sprinkler at a time so as to cover all portions of the system. Such a complete computer verification of performance of the system is most desirable, but unfortunately not all available computer verification programs currently do this.

This selection of the proper Hazen–Williams coefficient is important. New unlined steel pipe has a Hazen–Williams coefficient close to 140. However, it quickly deteriorates to 130 and, after a few years of use, to 120. Hence, the basis for normal design is a Hazen–Williams coefficient of 120 for steel-piped wet systems. A Hazen–Williams coefficient of 100 is generally used for dry pipe systems because of the increased tendency for deposits and corrosion in these systems. However, it should be realized that a new system will have fewer line losses than calculated, and the distribution pattern will be affected accordingly.

Conservatism can also be built into systems by intentionally designing to a lower Hazen–Williams coefficient than that indicated.

B.2.1.4 Ability to Predict Expected Performance from Calculated Performance. Ability to accurately predict the performance of a complex array of sprinklers on piping is basically a function of the pipe line velocity. The greater the velocity, the greater is the impact on difficult-to-assess pressure losses. These pressure losses are presently determined by empirical means that lose validity as velocities increase. This is especially true for fittings with unequal and more than two flowing ports.

The inclusion of velocity pressures in hydraulic calculations improves the predictability of the actual sprinkler system performance. Calculations should come as close as practicable to predicting actual performance. Conservatism in design should be arrived at intentionally by known and deliberate means. It should not be left to chance.

B.2.1.5 Future Upgrading of System Performance. It is desirable in some cases to build into the system the capability to achieve a higher level of sprinkler performance than needed at present. If this is to be a consideration in conservatism, consideration needs to be given to maintaining sprinkler operating pressures on the lower side of the optimum operating range and/or designing for low pipeline velocities, particularly on feed and cross mains, to facilitate future reinforcement.

B.3 Effect of Clearance to Ceiling on Sprinkler Performance.

The problems with large clearances to ceiling were well recognized by the 1970s in terms of the effect both on delayed sprinkler activation and on the effect on droplet penetration

through the fire plume. The work of Alpert (1972, 1975), Heskestad and Delichatsios (1979), and Beyler (1984) clearly identified the effect of clearance to ceiling on detection and activation of sprinklers. This was supplemented by the work of Heskestad and Smith (1976) in which the thermal responsiveness of sprinklers was studied and modeled. Similarly, the effect of the strong plumes resulting from large clearances to ceiling and highly challenging fires was recognized in the 1970s through the work of Yao and Kalelkar (1970), Yao (1976), and Yao (1980). This understanding was reflected in the development of large drop sprinklers in the 1970s [Yao (1997)]. The inability of ½ in. and 1½ in. standard sprinklers to penetrate high challenging fires was well understood and demonstrated in the 1970s [Yao (1976)]. The effect of excessive clearance was also demonstrated in the testing summarized in Annex C.

This understanding of the role of clearance to ceiling on fire performance had a strong effect on the development of advanced sprinkler technologies.

References:

Alpert, R. (1972), "Calculation of Response Time of Ceiling-mounted Fire Detectors," *Fire Technology* 8, pp. 181–195.

Alpert, R. (1975), "Turbulent Ceiling Jet Induced by Large Scale Fire," *Combustion Science and Technology* 11, pp. 197–213.

Beyler, C.L. (1984), "A Design Method for Flaming Fire Detection," *Fire Technology* 20, No. 4, 1984, p. 5.

Heskestad, G., and Smith, H. (1976), "Investigation of a New Sprinkler Sensitivity Approval Test: The Plunge Test," FMRC Serial No. 22485, Factory Mutual Research Corporation, Norwood, MA, December 1976.

Heskestad, G., and Delichatsios, M. (1979), "The Initial Convective Flow in Fire," Seventeenth Symposium (International) on Combustion, The Combustion Institute, Pittsburgh, PA, pp. 1113–1123.

Yao, C., and Kalelkar, A. (1970), "Effect of Drop Size on Sprinkler Performance," *Fire Technology* 6, 1970.

Yao, C. (1976), "Development of Large-Drop Sprinklers," FMRC Serial 22476, RC76-T-18, Factory Mutual Research Corporation, Norwood, MA.

Yao, C. (1980), "Application of Sprinkler Technology," Engineering Applications of Fire Technology, National Bureau of Standards, Gaithersburg MD, and FMRC RC80-TP-34.

Yao, C. (1997), "Overview of Sprinkler Technology Research," Fire Safety Science-Proceedings of the Fifth International Symposium, Y. Hasemi (Ed.), International Association for Fire Safety Science, Boston, MA, pp. 93–110.

Annex C Explanation of Test Data and Procedures for Rack Storage

This annex is not a part of the requirements of this NFPA document but is included for informational purposes only.

C.1

Annex C provides an explanation of the test data and procedures that led to the development of sprinkler system discharge criteria for rack storage applications. Numbers in brackets refer to paragraphs in the text.

C.2 [5.6]

A review of full-scale fire tests run on the standard commodity (double tri-wall carton with metal liner), of Hallmark products and 3M products (e.g., abrasives, pressure-sensitive tapes of plastic fiber, and paper), and of the considerable number of commodity tests conducted provides a guide for commodity classifications. Such guidance is not related to any other method of classification of materials; therefore, sound engineering judgment and analysis of the commodity and the packaging should be used when selecting a commodity classification.

C.3 [8.13.3.1]

Tests 71, 73, 81, 83, 91, 92, 95, and 100 in the 20 ft (6.1 m) high array involving a single level of in-rack sprinklers were conducted without heat or water shields. Results were satisfactory.

Test 115 was conducted with two levels of sprinklers in racks with shields. Test 116, identical to Test 115 but without water shields, produced a lack of control. Visual observation of lower level in-rack sprinklers that did not operate although they were in the fire area indicated a need for water shields.

Tests 115 and 116 were conducted to investigate the necessity for water shields where multiple levels of in-rack sprinklers are installed. Where water shields were not installed in Test 116, the fire jumped the aisle, and approximately 76 boxes were damaged. In Test 115 with water shields, the fire did not jump the aisle, and only 32 boxes were damaged. Water shields are, therefore, suggested wherever multiple levels of in-rack sprinklers are installed, except for installations with horizontal barriers or shelves that serve as water shields.

C.4 [8.16.1.8]

The time of operation of the first sprinkler varied from 52 seconds to 3 minutes and 55 seconds, with most tests under 3 minutes, except in Test 64 (Class III), where the first sprinkler operated in 7 minutes and 44 seconds. Fire detection more sensitive than waterflow is, therefore, considered necessary only in exceptional cases.

C.5 [8.16.5.1]

In most tests conducted, it was necessary to use small hose for mop-up operations. Small hose was not used in the high-expansion foam test.

Test 97 was conducted to evaluate the effect of dry pipe sprinkler operation. Test results were approximately the same as the base test with a wet pipe system. A study of NFPA

Copyright NFPA

records, however, indicates an increase in area of operation of 30 percent to be in order for dry pipe systems as compared with wet pipe systems.

C.6 [12.1.1]

Tests were conducted as a part of this program with eave line windows or louvers open to simulate smoke and heat venting. These tests opened 87.5 percent and 91 percent more sprinklers than did comparative tests without windows or louvers open. Venting tests that have been conducted in other programs were without the benefit of sprinkler protection and, as such, are not considered in this report, which covers only buildings protected by sprinklers. The design curves are based upon the absence of roof vents or draft curtains in the building. During mop-up operations, ventilating systems, where installed, should be capable of manual exhaust operations.

C.7 [12.12.1.3]

No tests were conducted with idle pallets in racks using standard spray sprinklers. However, tests were conducted using ESFR and large drop sprinklers. Such storage conceivably would introduce fire severity in excess of that contemplated by protection criteria for an individual commodity classification.

C.8 [12.2.1.2, 12.3.2.1.7, 12.3.3.1.11]

In all valid tests with double-row racks, sprinkler water supplies were shut off at approximately 60 minutes. In only one test did the last sprinkler operate in excess of 30 minutes after ignition; the last sprinkler operated in excess of 25 minutes in three tests, with the majority of tests involving the last sprinkler operating within 20 minutes.

C.9 [12.3]

The discharge criteria of Section uses as a basis the large-scale fire test series conducted at the Factory Mutual Research Center, West Glocester, Rhode Island.

The test building is approximately 200 ft × 250 ft (61 m × 76 m) [50,000 ft² (4.65 km²) in area], of fire-resistive construction, and contains a volume of approximately 2.25 million ft³ (63,720 m³), the equivalent of a 100,000 ft² (9.29 km²) building that is 22.5 ft (6.86 m) high. The test building has two primary heights beneath a single large ceiling. The east section is 30 ft (9.1 m) high, and the west section is 60 ft (18.29 m) high.

The test series for storage height of 20 ft (6.1 m) was conducted in the 30 ft (9.1 m) section with clearances from the top of storage to the ceiling nominally 10 ft (3.1 m).

Doors at the lower and intermediate levels and ventilation louvers at the tops of walls were kept closed during the majority of the fire tests, which minimized the effect of exterior conditions.

The entire test series was fully instrumented with thermocouples attached to rack members, simulated building columns, bar joists, and the ceiling.

Racks were constructed of steel vertical and horizontal members designed for 4000 lb (1814 kg) loads. Vertical members were 8 ft (2.4 m) on center for conventional racks and 4 ft (1.2

Copyright NFPA

m) on center for simulated automated racks. Racks were 3½ ft (1.07 m) wide with 6 in. (152.4 mm) longitudinal flue space for an overall width of 7½ ft (2.29 m). Simulated automated racks and slave pallets were used in the main central rack in the 4 ft (1.2 m) aisle tests. Conventional racks and conventional pallets were used in the main central rack in the 8 ft (2.4 m) aisle tests. The majority of the tests were conducted with 100 ft² (9.29 m²) sprinkler spacing.

The test configuration for storage heights of 15 ft (4.6 m), 20 ft (6.1 m), and 25 ft (7.6 m) covered an 1800 ft² (167.2 m²) floor area, including aisles between racks. Tests that were used in producing this standard limited fire damage to this area. The maximum water damage area anticipated in the standard is 6000 ft² (557.4 m²), the upper limit of the design curves.

The test data show that, as density is increased, both the extent of fire damage and sprinkler operation are reduced. The data also indicate that, with sprinklers installed in the racks, a reduction is gained in the area of fire damage and sprinkler operations (e.g., water damage).

Table C.9 illustrates these points. The information shown in the table is taken from the test series for storage height of 20 ft (6.1 m) using the standard commodity.

The fact that there is a reduction in both fire damage and area of water application as sprinkler densities are increased or where sprinklers are installed in racks should be considered carefully by those responsible for applying this standard to the rack storage situation.

In the test for storage height of 25 ft (7.6 m), a density of 0.55 gpm/ft² (22.4 mm/min) produced 42 percent, or 756 ft² (70.26 m²), fire damage in the test array and a sprinkler-wetted area of 1400 ft² (130.1 m²). Lesser densities would not be expected to achieve the same limited degree of control. Therefore, if the goal of smaller areas of fire damage is to be achieved, sprinklers in racks should be considered.

The test series for storage height over 25 ft (7.6 m) was conducted in the 60 ft (18.3 m) section of the test building with nominal clearances from the top of storage to the ceiling of either 30 ft (9.1 m) or 10 ft (3.1 m).

Doors at the lower and intermediate levels and ventilation louvers at the top of walls were kept closed during the fire tests, which minimized the effect of exterior wind conditions.

The purpose of the tests for storage height over 25 ft (7.6 m) was to accomplish the following:

- (1) Determine the arrangement of in-rack sprinklers that can be repeated as pile height increases and that provide control of the fire
- (2) Determine other protective arrangements, such as high-expansion foam, that provide control of the fire

Control was considered to have been accomplished if the fire was unlikely to spread from the rack of origin to adjacent racks or spread beyond the length of the 25 ft (7.6 m) test rack. To aid in this judgment, control was considered to have been achieved if the fire failed to exhibit the following characteristics:

- (1) Jump the 4 ft (1.2 m) aisles to adjoining racks
- (2) Reach the end face of the end stacks (north or south ends) of the main rack

Control is defined as holding the fire in check through the extinguishing system until the commodities initially involved are consumed or until the fire is extinguished by the extinguishing system or manual aid.

The standard commodity as selected in the 20 ft (6.1 m) test series was used in the majority of tests for storage over 25 ft (7.6 m). Hallmark products and 3M products described in the 20 ft (6.1 m) test series report also were used as representative of Class III or Class IV commodities, or both, in several tests. The results of privately sponsored tests on Hallmark products and plastic encapsulated standard commodities also were made available to the committee.

A 25 ft (7.6 m) long test array was used for the majority of the tests for storage over 25 ft (7.6 m). The decision to use such an array was made because it was believed that a fire in racks over 25 ft (7.6 m) high that extended the full length of a 50 ft (15.24 m) long rack could not be considered controlled, particularly as storage heights increased.

One of the purposes of the tests was to determine arrangements of in-rack sprinklers that can be repeated as pile height increases and that provide control of the fire. The tests for storage height of 30 ft (9.1 m) explored the effect of such arrays. Many of these tests, however, produced appreciable fire spread in storage in tiers above the top level of protection within the racks. (In some cases, a total burnout of the top tiers of both the main rack and the target rack occurred.) In the case of the 30 ft (9.1 m) Hallmark Test 134 on the 60 ft (18.3 m) site, the material in the top tiers of storage burned vigorously, and the fire jumped the aisle above the fourth tier. The fire then burned downward into the south end of the fourth tier. In the test on the floor, a nominal 30 ft (9.1 m) clearance occurred between the top of storage and the ceiling sprinklers, whereas on the platform this clearance was reduced to nominal 10 ft (3.1 m). In most cases, the in-rack sprinklers were effective in controlling fire below the top level of protection within the racks. It has been assumed by the Test Planning Committee that, in an actual case with a clearance of 10 ft (3.1 m) or less above storage, ceiling sprinklers would be expected to control damage above the top level of protection within the racks. Tests have been planned to investigate lesser clearances.

Tests 114 and 128 explore the effect of changing the ignition point from the in-rack standard ignition point to a face ignition location. It should be noted, however, that both of these tests were conducted with 30 ft (9.1 m) clearance from the ceiling sprinklers to the top of storage and, as such, ceiling sprinklers had little effect on the fire in the top two tiers of storage. Firespread in the three lower tiers is essentially the same. A similar change in the firespread where the ignition point is changed was noted in Tests 126 and 127. Once again, 30 ft (9.1 m) clearance occurred between the top of storage and the ceiling sprinklers, and, as such, the ceiling sprinklers had little effect on the face fire. Comparisons of Tests 129, 130, and 131 in the test series for storage height of 50 ft (15.24 m) indicate little effect of point of ignition in the particular configuration tested.

Test 125, when compared with Test 133, indicates no significant difference in result between

where the ignition point is changed was noted in Tests 126 and 127. Once again, 50 ft (9.1 m) clearance occurred between the top of storage and the ceiling sprinklers, and, as such, the ceiling sprinklers had little effect on the face fire. Comparisons of Tests 129, 130, and 131 in the test series for storage height of 50 ft (15.24 m) indicate little effect of point of ignition in the particular configuration tested.

Test 125, when compared with Test 133, indicates no significant difference in result between approved low-profile sprinklers and standard sprinklers in the racks.

Table C.9 Summary of Relationship Between Sprinkler Discharge Density and the Extent and Sprinkler Operation

Density (gpm/ft ²)	Fire Damage in Test Array		Sprinkler Operation
	%	ft ²	
0.30 (ceiling only)	22	395	45
0.375 (ceiling only)	17	306	
0.45 (ceiling only)	9	162	
0.20 (ceiling only)	28–36	504–648	13,1
0.20 (sprinklers at ceiling and in racks)	8	144	
0.30 (sprinklers at ceiling and in racks)	7	126	

For SI units, 1 ft = 0.3048 m; °C = $\frac{5}{9}$ (°F - 32); 1 gpm/ft² = 40.746 mm/min.

C.10 [12.3.1.7]

Temperatures in the test column were maintained below 1000°F (538°C) with densities, of roof ceiling sprinklers only, of 0.375 gpm/ft² (15.3 mm/min) with 8 ft (2.4 m) aisles and 0.45 gpm/ft² (18.3 mm/min) with 4 ft (1.2 m) aisles using the standard commodity.

C.11 [12.3.1.9.1]

Test 98 with solid shelves 24 ft (7.3 m) long and 7½ ft (2.3 m) deep at each level produced total destruction of the commodity in the main rack and jumped the aisle. Density was 0.3 gpm/ft² (12.2 mm/min) from the ceiling sprinklers only. Test 108 with shelves 24 ft (7.3 m) long and 3½ ft (1.07 m) deep and with a 6 in. (152.4 mm) longitudinal flue space and one level of sprinklers in the rack resulted in damage to most of the commodity in the main rack but did not jump the aisle. Density from ceiling sprinklers was 0.375 gpm/ft² (15.3 mm/min), and rack sprinklers discharged at 15 psi (1 bar).

These tests did not yield sufficient information to develop a comprehensive protection standard for solid shelf racks. Items such as increased ceiling density, use of bulkheads, other configurations of sprinklers in racks, and limitation of shelf length and depth should be considered.

Where such rack installations exist or are contemplated, the damage potential should be considered, and sound engineering judgment should be used in designing the protection system.

Test 98, with solid shelving obstructing both the longitudinal and transverse flue space, produced unsatisfactory results and indicates a need for sprinklers at each level in such a rack structure.

Test 147 was conducted with ceiling sprinklers only. Density was 0.45 gpm/ft² (18.3 mm/min) with a sprinkler spacing of 100 ft² (9.29 m²). A total of 47 sprinklers opened, and 83 percent of the commodity was consumed. The fire jumped both aisles and spread to both ends of the main and target racks. The test was considered unsuccessful.

Test 148 was conducted with ceiling sprinklers and in-rack sprinklers. In-rack sprinklers were provided at each level (top of first, second, and third tiers) and were located in the longitudinal flue. They were directly above each other and 24 ft (7.3 m) on center or 22 ft (6.7 m) on each side of the ignition flue. Ceiling sprinkler discharge density was 0.375 gpm/ft² (15.3 mm/min). In-rack sprinkler discharge pressure was 30 psi (2.1 bar). A total of 46 ceiling sprinklers and three in-rack sprinklers opened, and 34 percent of the commodity was consumed. The fire consumed most of the material between the in-rack sprinklers and jumped both aisles.

C.12 [12.3.1.10]

Fire tests with open-top containers in the upper tier of storage and a portion of the third tier of storage produced an increase in sprinkler operation from 36 to 41 sprinklers and a more pronounced aisle jump and increase in firespread in the main array. The smooth underside of

Copyright NFPA

the containers closely approximates fire behavior of slave pallets.

Installation of in-rack sprinklers or an increase in ceiling sprinkler density should be considered.

C.13 [12.3.1.13]

Test 80 was conducted to determine the effect of closing back-to-back longitudinal 6 in. (152.4 mm) flue spaces in conventional pallet racks. Test results indicated fewer sprinklers operating than with the flue space open, and, as such, no minimum back-to-back clearance is necessary if the transverse flue space is kept open.

Tests 145 and 146 were conducted to investigate the influence of longitudinal and transverse flue dimensions in double-row racks without solid shelves. Results were compared with Tests 65 and 66. Flue dimensions in Tests 65, 66, 145, and 146 were 6 in. (152.4 mm), 6 in. (152.4 mm), 3 in. (76.2 mm), and 12 in. (0.3 m), respectively. All other conditions were the same.

In Tests 65 and 66, 45, and 48, sprinklers operated compared with 59 and 58 for Tests 145 and 146, respectively. Fire damage in Tests 145 and 146 was somewhat less than in Tests 65 and 66; 2100 ft³ (59.51 m³) and 1800 ft³ (51 m³) in Tests 145 and 146, respectively, versus 2300 ft³ (65.13 m³) and 2300 ft³ (65.13 m³) in Tests 65 and 66, respectively, of combustible material were consumed.

Test results indicate narrow flue spaces of about 3 in. (76.2 mm) allow reasonable passage of sprinkler water down through the racks.

Tests 96 and 107, on multiple-row racks, used 6 in. (152.4 mm) transverse flue spaces. The water demand recommended in the standard is limited to those cases with nominal 6 in. (152.4 mm) transverse flues in vertical alignment.

C.14 [12.3.2.1.1.1]

Tests 65 and 66, compared with Test 69, and Test 93, compared with Test 94, indicated a reduction in areas of application of 44.5 percent and 45.5 percent, respectively, with high temperature-rated sprinklers as compared with ordinary temperature-rated sprinklers. Other extensive Factory Mutual tests produced an average reduction of 40 percent. Design curves are based on this area reduction. In constructing the design curves, the high-temperature curves above 3600 ft² (334.6 m²) of application, therefore, represent 40 percent reductions in area of application of the ordinary temperature curves in the 6000 ft² to 10,000 ft² (557.6 m² to 929.41 m²) range.

Test 84 indicated the number of intermediate temperature-rated sprinklers operating is essentially the same as ordinary temperature-rated sprinklers.

C.15 [12.3.2.1.2.1]

Tests were not conducted with aisles wider than 8 ft (2.4 m) or narrower than 4 ft (1.2 m). It is, therefore, not possible to determine whether lower ceiling densities should be used for aisle widths greater than 8 ft (2.4 m) or if higher densities should be used for aisle widths less

than 4 ft (1.2 m).

C.16 [12.3.2.4.2.3]

In one 20 ft (6.1 m) high test, sprinklers were buried in the flue space 1 ft (0.3 m) above the bottom of the pallet load, and results were satisfactory. Coverage of aisles by in-rack sprinklers is, therefore, not necessary, and distribution across the tops of pallet loads at any level is not necessary for the occupancy classes tested.

C.17 [12.3.2.4.2.6]

In all tests with in-rack sprinklers, obstructions measuring 3 in. × 3 ft (76.2 mm × 0.3 m) were introduced on each side of the sprinkler approximately 3 in. (76.2 mm) from the sprinkler to simulate rack structure member obstruction. This obstruction had no effect on sprinkler performance in the 20 ft (6.1 m) high tests.

Tests 103, 104, 105, and 109 in the 30 ft (9.1 m) high test with in-rack sprinklers obstructed by rack uprights produced unsatisfactory results. Tests 113, 114, 115, 117, 118, and 120 in the 30 ft (9.1 m) high test series with in-rack sprinklers located a minimum of 2 ft (0.61 m) from rack uprights produced improved results.

C.18 [12.3.2.4.3]

In all except one case, using the standard commodity with one line of sprinklers installed in racks, only two sprinklers opened. In the one exception, two sprinklers opened in the main rack, and two sprinklers opened in the target rack.

C.19 [12.3.2.4.4 and 12.3.3.4.4]

Operating pressures were 15 psi (1 bar) on all tests of sprinklers in racks with storage 20 ft (6.1 m) high and 30 psi (2.1 bar) for storage 30 ft (9.1 m) and 50 ft (15.24 m) high.

Tests 112 and 124 were conducted to compare the effect of increasing sprinkler discharge pressure at in-rack sprinklers from 30 psi to 75 psi (2.1 bar to 5.2 bar). With the higher discharge pressure, the fire did not jump the aisle, and damage below the top level of protection within the racks was somewhat better controlled by the higher discharge pressure of the in-rack sprinklers. A pressure of 15 psi (1 bar) was maintained on in-rack sprinklers in the first 30 ft (9.1 m) high tests (Tests 103 and 104). Pressure on in-rack sprinklers in subsequent tests was 30 psi (2.1 bar), except in Test 124, where it was 75 psi (5.2 bar).

C.20 [12.3.2.5.1.1 and 12.3.3.5.1.1]

A full-scale test program was conducted with various double-row rack storage arrangements of a cartoned Group A unexpanded plastic commodity at the Factory Mutual Research Corporation (FMRC) test facility. The series of nine tests included several variations, one of which involved the use of the following four distinct shelving arrangements: slatted wood, solid wood, wire mesh, and no shelving. The results of the testing program, specifically Tests 1, 2, 3, and 5, clearly demonstrate the acceptable performance of sprinkler systems protecting storage configurations that involve the use of slated shelving as described in 16.2.5.1.1 and 17.2.5.1.1. As a result of the test program, Factory Mutual has amended FM

Copyright NFPA

Loss Prevention Data Sheet 8-9 to allow slatted shelving to be protected in the same manner as an open rack arrangement.

Complete details of the test program are documented in the FMRC technical report FMRC J. I. 0X1R0.RR, "Large-Scale Fire Tests of Rack Storage Group A Plastics in Retail Operation Scenarios Protected by Extra Large Orifice (ELO) Sprinklers."

C.21 [12.3.3.1.1]

In the RSP rack storage test series as well as the stored plastics program palletized test series, compartmented 16 oz (0.47 L) polystyrene jars were found to produce significantly higher protection requirements than the same commodity in a nested configuration.

Polystyrene glasses and expanded polystyrene plates were comparable to the nested jars.

Different storage configurations within cartons or different products of the same basic plastic might, therefore, require reduced protection requirements.

In Test RSP-7, with nominal 15 ft (4.6 m) high storage with compartmented jars, a 0.6 gpm/ft² (24.5 mm/min) density, 8 ft (2.4 m) aisles, and a 10 ft (3.1 m) clearance to ceiling, 29 sprinklers opened. In Tests RSP-4 with polystyrene glasses, RSP-5 with expanded polystyrene plates, and RSP-16 with nested polystyrene jars all stored at nominal 15 ft (4.6 m) height, 10 ft (3.1 m) clearance to ceiling, 8 ft (2.4 m) aisles, and 0.6 gpm/ft² (24.5 mm/min) density, only four sprinklers opened.

However, Test RSP-11, with expanded polystyrene plates and 6 ft (1.8 m) aisles, demonstrated an increase in the number of operating sprinklers to 29. Test RSP-10 with expanded polystyrene plates, nominally 15 ft (4.6 m) high with a 10 ft (3.1 m) clearance and 8 ft (2.4 m) aisles, but protected only by 0.45 gpm/ft² (18.3 mm/min) density, opened 46 sprinklers and burned 100 percent of the plastic commodity.

At a nominal 20 ft (6.1 m) storage height with 8 ft (2.4 m) aisles, a 3 ft (0.9 m) clearance to ceiling, and a 0.6 gpm/ft² (24.5 mm/min) density opened four sprinklers with polystyrene glasses in Test RSP-2 and 11 sprinklers with expanded polystyrene plates in Test RSP-6. In Test RSP-8, however, with the clearance to ceiling increased to 10 ft (3.1 m) and other variables held constant, 51 sprinklers opened, and 100 percent of the plastic commodity burned.

Test RSP-3, with polystyrene glasses at a nominal height of 25 ft (7.6 m) with a 3 ft (0.9 m) clearance to ceiling, 8 ft (2.4 m) aisles, and 0.6 gpm/ft² (24.5 mm/min) ceiling sprinkler density in combination with one level of in-rack sprinklers, resulted in four ceiling sprinklers and two in-rack sprinklers operating. Test RSP-9, with the same configuration but with polystyrene plates, opened 12 ceiling sprinklers and three in-rack sprinklers.

No tests were conducted with compartmented polystyrene jars at storage heights in excess of a nominal 15 ft (4.6 m) as a part of this program.

C.22 [12.3.3.1.5]

The protection of Group A plastics by extra large orifice (ELO) sprinklers designed to provide 0.6 gpm/ft²/2000 ft² (24.5 mm/min/186 m²) or 0.45 gpm/ft²/2000 ft² (18.3

mm/min/186 m²) without the installation of in-rack sprinklers was developed from full-scale testing conducted with various double-row rack storage arrangements of a cartoned Group A unexpanded plastic commodity at the Factory Mutual Research Corporation (FMRC) test facility. The results of this test program are documented in the FMRC technical report, FMRC J.I. 0X1R0.RR, “Large-Scale Fire Tests of Rack Stored Group A Plastics in Retail Operation Scenarios Protected by Extra Large Orifice (ELO) Sprinklers.” The test program was initiated to address the fire protection issues presented by warehouse-type retail stores with regard to the display and storage of Group A plastic commodities including, but not limited to, acrylonitrile-butadiene-styrene copolymer (ABS) piping, polyvinyl chloride (PVC) hose and hose racks, tool boxes, polypropylene trash and storage containers, and patio furniture. Tests 1 and 2 of this series included protection of the Group A plastic commodity stored to 20 ft (6.1 m) under a 27 ft (8.2 m) ceiling by a design density of 0.6 gpm/ft² (24.5 mm/min) utilizing ELO sprinklers. The results of the testing program clearly demonstrate the acceptable performance of sprinkler systems that protect storage configurations involving Group A plastics up to 20 ft (6.1 m) in height under a 27 ft (8.2 m) ceiling where using ELO sprinklers to deliver a design density of 0.6 gpm/ft² (24.5 mm/min) and Group A plastics up to 14 ft (4.3 m) in height under a 22 ft (6.7 m) ceiling where using ELO sprinklers to deliver a design density of 0.45 gpm/ft² (18.3 mm/min). The tabulation of the pertinent tests shown in Table C.22 demonstrates acceptable performance.

Table C.22 Summary of Test Results for Plastic Commodities Using $\frac{5}{8}$ in. (15

Test Parameters	Date of Test				
	8/20/93	8/25/93	9/2/93	10/7/93	2
Type of shelving	Slatted wood	Slatted wood	Slatted wood	Slatted wood	Slatted wood
Other conditions/ inclusions	—	—	—	—	Draft
Storage height (ft-in.)	19-11	19-11	15-4	15-4	19-11
Number of tiers	6 ^a	6 ^a	5 ^b	5 ^b	6 ^a
Clearance to ceiling/sprinklers (ft-in.)	6-10/6-3	6-10/6-3	11-5/10-10	11-5/10-10	6-10/
Longitudinal/ transverse flues (in.)	6/6 to 7½	6/6 to 7½	6/6 to 7	6/6 to 7½	6/6 to
Aisle width (ft)	7½	7½	7½	7½	7½
Ignition centered below (number of sprinklers)	2	2	1	1	2
Sprinkler orifice size (in.)	0.64	0.64	0.64	0.64	0.64
Sprinkler temperature rating (°F)	165	286	286	165	165
Sprinkler RTI (ft-sec) ^{1/2}	300	300	300	300	300
Sprinkler spacing (ft × ft)	8 × 10	8 × 10	8 × 10	8 × 10	8 × 10
Sprinkler identification	ELO-231	ELO-231	ELO-231	ELO-231	ELO-231
Constant water pressure (psi)	19	19	19	19	19
Minimum density (gpm/ft ²)	0.6	0.6	0.6	0.6	0.6
Test Results					
First sprinkler operation (min:sec)	2:03	2:25	1:12	0:44	1:25

Table C.22 Summary of Test Results for Plastic Commodities Using $\frac{5}{8}$ in. (15

Test Parameters	Date of Test				
	8/20/93	8/25/93	9/2/93	10/7/93	2
Last sprinkler operation (min:sec)	2:12	15:19	6:34	7:34	15:54
Total sprinklers opened	4	9	7	13	35
Total sprinkler discharge (gpm)	205	450	363	613	1651
Average discharge per sprinkler (gpm)	51	50	52	47	47
Peak/maximum 1-min average gas temperature (°F)	1107/566	1412/868	965/308	662/184	1575.
Peak/maximum 1-min average steel temperature (°F)	185/172	197/196	233/232	146/145	226/2
Peak/maximum 1-min average plume velocity (ft/sec)	27/15	25/18	18/15 ^d	14/10 ^d	26/23
Peak/maximum 1-min heat flux (Btu/ft ² /sec)	0.6/0.5	2.0/1.9	2.8/2.5	1.1/0.8	1.0/0
Aisle jump, east/west target ignition (min:sec)	None	8:24/None	5:35/10:10	None	None
Equivalent number of pallet loads consumed	3	9	6	5	12
Test duration (min)	30	30	30	30	30
Results acceptable	Yes	Yes	Yes	Yes	No ^f

For SI units, 1 ft = 0.305 m; 1 in. = 25.4 mm; °F = (1.8 × °C) + 32; °C = (°F - 32)/1.8; 1 psi = 0.069 bar; 1 gpm/ft² = 40.746 mm/min.

^a Main (ignition) racks divided into five or six tiers; bottom tiers each approximately 2 ft (0.6 m) high and upper shelving below commodity at second through fifth tiers.

^b Main (ignition) racks divided into five or six tiers; bottom tiers each approximately 2 ft (0.6 m) high and upper shelving below commodity at second through fifth tiers; wire mesh shelving below commodity at sixth tier or less.

^c Transverse flues spaced 8 ft (2.4 m) apart [versus 3½ ft (1.1 m) apart in all other tests].

^d Instrumentation located 5 ft (1.5 m) north of ignition.

^e Minor surface damage to cartons.

^f High water demand.

^g Excessive firespread; marginally high water demand.

C.23 [12.3.4.1.1]

The recommended use of ordinary temperature-rated sprinklers at ceiling for storage higher than 25 ft (7.6 m) was determined by the results of fire test data. A test with high temperature-rated sprinklers and 0.45 gpm/ft² (18.3 mm/min) density resulted in fire damage in the two top tiers just within acceptable limits, with three ceiling sprinklers operating. A test with 0.45 gpm/ft² (18.3 mm/min) density and ordinary temperature-rated sprinklers produced a dramatic reduction in fire damage with four ceiling sprinklers operating.

The four ordinary temperature-rated ceiling sprinklers operated before the first of the three high temperature-rated ceiling sprinklers. In both tests, two in-rack sprinklers at two levels operated at approximately the same time. The high temperature-rated sprinklers were at all

times fighting a larger fire with less water than the ordinary temperature-rated ceiling sprinklers.

Tests 115 and 119 compare ceiling sprinkler density of 0.3 gpm/ft² (12.2 mm/min) with 0.45 gpm/ft² (18.3 mm/min). Damage patterns coupled with the number of boxes damaged in the main rack suggest that the increase in density produces improved control, particularly in the area above the top tier of in-rack sprinklers.

Tests 119 and 122 compare ceiling sprinkler temperature ratings of 286°F (141°C) and 165°F (74°C). A review of the number of boxes damaged and the firespread patterns indicates that the use of ordinary temperature-rated ceiling sprinklers on a rack configuration that incorporates in-rack sprinklers dramatically reduces the amount of firespread. Considering that in-rack sprinklers in the tests for storage over 25 ft (7.6 m) operated prior to ceiling sprinklers, it would seem that the installation of in-rack sprinklers converts an otherwise rapidly developing fire, from the standpoint of ceiling sprinklers, to a slower developing fire with a lower rate of heat release.

In the 20 ft (6.1 m) high test series, ceiling sprinklers operated before in-rack sprinklers. In the 30 ft (9.1 m) high series, ceiling sprinklers operated after in-rack sprinklers. The 50 ft (15.24 m) high test did not operate ceiling sprinklers. Ceiling sprinklers would, however, be needed if fire occurred in upper levels.

The results of these tests indicate the effect of in-rack sprinklers on storage higher than 25 ft (7.6 m). From the ceiling sprinkler operation standpoint, a fire with an expected high heat release rate was converted to a fire with a much lower heat release rate.

Since the fires developed slowly and opened sprinklers at two levels in the racks, only a few ceiling sprinklers were needed to establish control. Thus, the sprinkler operating area does not vary with height for storage over 25 ft (7.6 m) or for changes in sprinkler temperature rating and density.

All tests with sprinklers in racks were conducted using nominal ½ in. (12.7 mm) orifice size sprinklers of ordinary temperature.

Annex D Sprinkler System Information from the 1997 Edition of the *Life Safety Code*

This annex is not a part of the requirements of this NFPA document but is included for informational purposes only.

D.1 Introduction.

This annex is provided as an aid to the user of NFPA 13 by identifying those portions of the 1997 edition of NFPA 101, *Life Safety Code*, that pertain to sprinkler system design and installation. It is not intended that this annex provide complete information regarding all aspects of fire protection addressed by NFPA 101. It is important to note that this information was not copied from NFPA 101 using NFPA's extract policy and is not intended to be a part of the requirements of NFPA 13. While the 1997 edition of the *Life Safety Code*

was the most current at the time of the publication of the 1999 edition of NFPA 13, a 2000 edition of the *Life Safety Code* is in preparation.

D.2 Definitions.

See NFPA 101, *Life Safety Code*, for terms not defined in Chapter 3.

D.3 Atriums.

Glass walls and inoperable windows shall be permitted in lieu of the fire barriers where automatic sprinklers are spaced 6 ft (1.8 m) apart or less along both sides of the glass wall and inoperable windows, not more than 1 ft (0.3 m) from the glass, and with the automatic sprinklers located so that the entire surface of the glass is wet upon operation of the sprinklers. The glass shall be tempered, wired, or laminated glass held in place by a gasket system that permits the glass framing system to deflect without breaking (loading) the glass before the sprinklers operate. Automatic sprinklers shall not be required on the atrium side of the glass wall and inoperable windows where there is no walkway or other floor area on the atrium side above the main floor level. Doors in such walls shall be glass or other material that will resist the passage of smoke. Doors shall be self-closing or automatic-closing upon detection of smoke. [**101:6.2.4.6**, Exception No. 2 to (a)]

D.4 Connection to Domestic Water Supply.

Sprinkler piping serving not more than six sprinklers for any isolated hazardous area shall be permitted to be connected directly to a domestic water supply system having a capacity sufficient to provide 0.15 gpm/ft² (6.1 L/min/m²) of floor area throughout the entire enclosed area. An indicating shut-off valve shall be installed in an accessible location between the sprinklers and the connection to the domestic water supply. [**101:7.7.1.2**]

D.5 Supervision.

[**101: 7.7.2**]

D.5.1 Supervisory Signals. Where supervised, automatic sprinkler systems are required by another section of NFPA 101, supervisory attachments shall be installed and monitored for integrity in accordance with NFPA 72, *National Fire Alarm Code*, and a distinctive supervisory signal shall be provided to indicate a condition that would impair the satisfactory operation of the sprinkler system. This shall include, but not be limited to, monitoring of control valves, fire pump power supplies and running conditions, water tank levels and temperatures, pressure of tanks, and air pressure on dry-pipe valves. Supervisory signals shall sound and shall be displayed either at a location within the protected building that is constantly attended by qualified personnel or at an approved, remotely located receiving facility. [**101:7.7.2.1**]

D.5.2 Alarm Signal Transmission. Where supervision of automatic sprinkler systems is provided in accordance with another provision of NFPA 101, waterflow alarms shall be transmitted to an approved, proprietary alarm receiving facility, a remote station, a central station, or the fire department. Such connection shall be installed in accordance with 7.6.1.4 of NFPA 101. [**101:7.7.2.2**]

Copyright NFPA

D.6 Stages.

D.6.1 Sprinklers shall not be required for stages 1000 ft² (93 m²) or less in area and 50 ft (15 m) or less in height where curtains, scenery, or other combustible hangings are not retractable vertically. Combustible hangings shall be limited to a single main curtain, borders, legs, and a single backdrop. [**101**:8.4.5.10, Exception No. 1]

D.6.2 Sprinklers shall not be required under stage areas less than 4 ft (1.2 m) in clear height used exclusively for chair or table storage and lined on the inside with $\frac{3}{8}$ in. (1.6 cm) Type X gypsum wallboard or the approved equivalent. [**101**:8.4.5.10, Exception No. 2]

D.7 Exhibition Booths.

The following shall be protected by automatic extinguishing systems:

- (1) Single-level exhibit booths greater than 300 ft² (27.9 m²) and covered with a ceiling
- (2) Throughout each level of multilevel exhibit booths, including the uppermost level if the uppermost level is covered with a ceiling
- (3) A single exhibit or group of exhibits with ceilings that do not require sprinklers shall be separated by a minimum of 10 ft (3 m) where the aggregate ceiling exceeds 300 ft² (27.9 m²)

The water supply and piping for the sprinkler system shall be permitted to be of approved temporary means taken from an existing domestic water supply, an existing standpipe system, or an existing sprinkler system.

Exception No. 1: Ceilings that are constructed of open grate design or listed dropout ceilings in accordance with NFPA 13 shall not be considered ceilings within the context of this section.

Exception No. 2: Vehicles, boats, and similar exhibited products having over 100 ft² (9.3 m²) of roofed area shall be provided with smoke detectors acceptable to the authority having jurisdiction.

Exception No. 3: Where fire protection of multilevel exhibit booths is consistent with the criteria developed through a life safety evaluation of the exhibition hall in accordance with 8.4.1 of NFPA 101, subject to approval of the authority having jurisdiction. (See A.8.2.3.2 of NFPA 101.)

[**101**:8.7.5.3.7]

D.8 Proscenium Curtain.

The proscenium opening of every legitimate stage shall be provided with a curtain constructed and mounted so as to intercept hot gases, flames, and smoke and to prevent flame from a fire on the stage from becoming visible from the auditorium side for a 5-minute period where the curtain is of asbestos. Other materials shall be permitted if they have passed a 30-minute fire test in a small scale 3 ft × 3 ft (0.9 m × 0.9 m) furnace with the sample mounted in the horizontal plane at the top of the furnace and subjected to the standard

time–temperature curve.

The curtain shall be automatic-closing without the use of applied power.

All proscenium curtains shall be in the closed position except during performances, rehearsals, or similar activities.

Exception No. 1: In lieu of the protection required herein, all the following shall be provided:

- (1) *A noncombustible opaque fabric curtain shall be arranged so that it will close automatically.*
- (2) *An automatic, fixed waterspray deluge system shall be located on the auditorium side of the proscenium opening and shall be arranged so that the entire face of the curtain will be wetted. The system shall be activated by combination of rate-of-rise and fixed-temperature detectors located on the ceiling of the stage. Detectors shall be spaced in accordance with their listing. The water supply shall be controlled by a deluge valve and shall be sufficient to keep the curtain completely wet for 30 minutes or until the valve is closed by fire department personnel.*
- (3) *The curtain shall be automatically operated in case of fire by a combination of rate-of-rise and fixed-temperature detectors that also activates the deluge spray system. Stage sprinklers and vents shall be automatically operated by fusible elements in case of fire.*
- (4) *Operation of the stage sprinkler system or spray deluge valve shall automatically activate the emergency ventilating system and close the curtain.*
- (5) *The curtain, vents, and spray deluge system valve shall also be capable of manual operation.*

Exception No. 2: Proscenium fire curtains or water curtains complying with 8.4.5.7 of NFPA 101.

[101: 9.4.5.7]

D.9

Listed quick-response or listed residential sprinklers shall be used throughout smoke compartments containing patient sleeping rooms. [101:12.3.5.2]

The requirements for use of quick-response sprinklers intends that quick-response sprinklers be the predominant type of sprinkler installed in the smoke compartment. It is recognized, however, that quick-response sprinklers may not be approved for installation in all areas such as those where NFPA 13 requires sprinklers of the intermediate- or high-temperature classification. It is not the intent of the 12-3.5.2 of NFPA 101 requirements to prohibit the use of standard sprinklers in limited areas of a smoke compartment where intermediate- or high-temperature sprinklers are required.

Where the installation of quick-response sprinklers is impracticable in patient sleeping room areas, appropriate equivalent protection features acceptable to the authority having

Copyright NFPA

jurisdiction should be provided. It is recognized that the use of quick-response sprinklers may be limited in facilities housing certain types of patients, or due to the installation limitations of quick-response sprinklers. [**101**: A.12.3.5.2]

D.10

Where an automatic sprinkler system is installed, either for total or partial building coverage, the system shall be installed in accordance with Section 7.7 of NFPA 101. In buildings up to and including four stories in height, systems installed in accordance with NFPA 13R, *Standard for the Installation of Sprinkler Systems in Residential Occupancies up to and Including Four Stories in Height*, shall be permitted.

Exception No. 1: In individual dwelling units, sprinkler installation shall not be required in closets not over 12 ft² (1.1 m²). Closets that contain equipment such as washers, dryers, furnaces, or water heaters shall be sprinklered regardless of size.

Exception No. 2: The draft stop and closely spaced sprinkler requirements of NFPA 13 shall not be required for convenience openings complying with 6.2.4.8 of NFPA 101 where the convenience opening is within the dwelling unit.

[**101**:18.3.5.1]

Annex E Informational References

E.1 Referenced Publications.

The documents or portions thereof listed in this annex are referenced within the informational sections of this standard and are not part of the requirements of this document unless also listed in Chapter 2 for other reasons.

E.1.1 NFPA Publications. National Fire Protection Association, 1 Batterymarch Park, Quincy, MA 02169-7471.

NFPA 13E, *Recommended Practice for Fire Department Operations in Properties Protected by Sprinkler and Standpipe Systems*, 2005 edition.

NFPA 13R, *Standard for the Installation of Sprinkler Systems in Residential Occupancies up to and Including Four Stories in Height*, 2007 edition.

NFPA 14, *Standard for the Installation of Standpipe and Hose Systems*, 2007 edition.

NFPA 15, *Standard for Water Spray Fixed Systems for Fire Protection*, 2007 edition.

NFPA 16, *Standard for the Installation of Foam-Water Sprinkler and Foam-Water Spray Systems*, 2003 edition.

NFPA 20, *Standard for the Installation of Stationary Pumps for Fire Protection*, 2007 edition.

NFPA 22, *Standard for Water Tanks for Private Fire Protection*, 2003 edition.

NFPA 25, *Standard for the Inspection, Testing, and Maintenance of Water-Based Fire*
Copyright NFPA

Protection Systems, 2002 edition.

NFPA 36, *Standard for Solvent Extraction Plants*, 2004 edition.

NFPA 72®, *National Fire Alarm Code®*, 2007 edition.

NFPA 80A, *Recommended Practice for Protection of Buildings from Exterior Fire Exposures*, 2007 edition.

NFPA 101®, *Life Safety Code®*, 2006 edition.

NFPA 220, *Standard on Types of Building Construction*, 2006 edition.

NFPA 232, *Standard for the Protection of Records*, 2007 edition.

NFPA 291, *Recommended Practice for Fire Flow Testing and Marking of Hydrants*, 2007 edition.

NFPA 307, *Standard for the Construction and Fire Protection of Marine Terminals, Piers, and Wharves*, 2006 edition.

NFPA 409, *Standard on Aircraft Hangars*, 2004 edition.

NFPA 703, *Standard for Fire Retardant–Treated Wood and Fire-Retardant Coatings for Building Materials*, 2006 edition.

NFPA 850, *Recommended Practice for Fire Protection for Electric Generating Plants and High Voltage Direct Current Converter Stations*, 2005 edition.

NFPA 851, *Recommended Practice for Fire Protection for Hydroelectric Generating Plants*, 2005 edition.

E.1.2 Other Publications.

E.1.2.1 ACPA Publication. American Concrete Pipe Association, 222 W. Las Collinas Boulevard, Suite 641, Irving, TX 75039.

Concrete Pipe Handbook.

E.1.2.2 ASCE Publications. American Society of Civil Engineers, 1801 Alexander Bell Drive, Reston, VA 20191-4400.

SEI/ASCE 7, *Minimum Design Loads for Buildings and Other Structures*, 2005.

ASCE 19, *Standard Guidelines for the Structural Applications of Steel Cables for Buildings*, 1996.

E.1.2.3 ASME Publications. American Society of Mechanical Engineers, Three Park Avenue, New York, NY 10016-5990.

ASME A17.1, *Safety Code for Elevators and Escalators*, 1996.

ASME B16.1, *Cast-Iron Pipe Flanges and Flanged Fittings*, 1989.

ASME B1.20.1, *Pipe Threads, General Purpose (Inch)*, 1983.

E.1.2.4 ASTM Publications. American Society for Testing and Materials, 100 Barr Harbor

Copyright NFPA

Drive, P.O. Box C700, West Conshohocken, PA 19428-2959.

ASTM A 126, *Standard Specification for Gray Iron Casting for Valves, Flanges, and Pipe Fittings*, 1995.

ASTM A 135, *Standard Specification for Electric-Resistance-Welded Steel Pipe*, 1997.

ASTM A 197, *Standard Specification for Cupola Malleable Iron*, 1987.

ASTM A 307, *Standard Specification for Carbon Steel Bolts and Studs*, 1997.

ASTM A 603, *Standard Specification for Zinc-Coated Steel Structural Wire Rope*, 1998.

ASTM C 296, *Standard Specification for Asbestos-Cement Pressure Pipe*, 1988.

ASTM C 635, *Standard Specification for the Manufacture, Performance, and Testing of Metal Suspension Systems of Acoustical Tile and Lay-In Panel Ceilings*, 2004.

ASTM C 636, *Standard Practice for Installation of Metal Ceiling Suspension Systems for Acoustical Tile and Lay-In Panels*, 2004.

ASTM D 3309, *Standard Specification for Polybutylene (PB) Plastic and Hot- and Cold-Water Distribution Systems*, 1996.

ASTM E 8, *Structural Test Method for Tension Testing of Metallic Materials*, 2001.

ASTM E 119, *Standard Test Methods for Fire Tests of Building Construction and Materials*, 1998.

ASTM F 437, *Standard Specification for Threaded Chlorinated Poly (Vinyl Chloride) (CPVC) Plastic Pipe Fittings, Schedule 80*, 1996.

ASTM F 438, *Standard Specification for Socket-Type Chlorinated Poly (Vinyl Chloride) (CPVC) Plastic Pipe Fittings, Schedule 40*, 1997.

ASTM F 439, *Standard Specification for Socket-Type Chlorinated Poly (Vinyl Chloride) (CPVC) Plastic Pipe Fittings, Schedule 80*, 1997.

ASTM F 442, *Standard Specification for Chlorinated Poly (Vinyl Chloride) (CPVC) Plastic Pipe (SDR-PR)*, 1997.

E.1.2.5 AWWA Publications. American Water Works Association, 6666 West Quincy Avenue, Denver, CO 80235.

AWWA C104, *Cement Mortar Lining for Ductile Iron Pipe and Fittings for Water*, 1995.

AWWA C105, *Polyethylene Encasement for Ductile Iron Pipe Systems*, 1993.

AWWA C110, *Ductile Iron and Gray Iron Fittings, 3-in. Through 48-in., for Water and Other Liquids*, 1993.

AWWA C111, *Rubber-Gasket Joints for Ductile Iron Pressure Pipe and Fittings*, 1990.

AWWA C115, *Flanged Ductile Iron Pipe with Ductile Iron or Gray Iron Threaded Flanges*, 1994.

AWWA C116, *Protective Fusion-Bonded Epoxy Coatings for the Interior and Exterior*

Copyright NFPA

Surfaces of Ductile-Iron and Gray Iron Fittings for Water Supply Service, 2003.

AWWA C150, *Thickness Design of Ductile Iron Pipe*, 1996.

AWWA C151, *Ductile Iron Pipe, Centrifugally Cast for Water*, 1996.

AWWA C153, *Ductile Iron Compact Fittings, 3 in. through 24 in. and 54 in. through 64 in. for Water Service*, 1994.

AWWA C203, *Coal-Tar Protective Coatings and Linings for Steel Water Pipelines Enamel and Tape — Hot Applied*, 1997.

AWWA C205, *Cement-Mortar Protective Lining and Coating for Steel Water Pipe 4 in. and Larger — Shop Applied*, 1995.

AWWA C206, *Field Welding of Steel Water Pipe*, 1997.

AWWA C208, *Dimensions for Fabricated Steel Water Pipe Fittings*, 1996.

AWWA C300, *Reinforced Concrete Pressure Pipe, Steel-Cylinder Type, for Water and Other Liquids*, 1997.

AWWA C301, *Prestressed Concrete Pressure Pipe, Steel-Cylinder Type, for Water and Other Liquids*, 1992.

AWWA C302, *Reinforced Concrete Pressure Pipe, Non-Cylinder Type, for Water and Other Liquids*, 1995.

AWWA C303, *Reinforced Concrete Pressure Pipe, Steel-Cylinder Type, Pretensioned, for Water and Other Liquids*, 1995.

AWWA C400, *Standard for Asbestos-Cement Distribution Pipe, 4 in. Through 16 in., for Water and Other Liquids*, 1993.

AWWA C401, *Standard Practice for the Selection of Asbestos-Cement Water Pipe*, 1993.

AWWA C600, *Standard for the Installation of Ductile-Iron Water Mains and Their Appurtenances*, 1993.

AWWA C602, *Cement-Mortar Lining of Water Pipe Lines 4 in. and Larger — in Place*, 1995.

AWWA C603, *Standard for the Installation of Asbestos-Cement Water Pipe*, 1996.

AWWA C606, *Grooved and Shouldered Joints*, 1997.

AWWA C900, *Polyvinyl Chloride (PVC) Pressure Pipe, 4 in. Through 12 in., for Water and Other Liquids*, 1997.

AWWA M9, *Concrete Pressure Pipe*.

AWWA M11, *A Guide for Steel Pipe Design and Installation*, 3rd edition, 1989.

AWWA M14, *Recommended Practice for Backflow Prevention and Cross Connection Control*, 2nd edition, 1990.

AWWA M41, *Ductile Iron and Pipe Fittings*.

E.1.2.6 DIRPA Publications. Ductile Iron Pipe Research Association, 245 Riverchase Parkway, East, Suite 0, Birmingham, AL 35244.

Installation Guide for Ductile Iron Pipe.

Thrust Restraint Design for Ductile Iron Pipe.

E.1.2.7 EPRI Publications. EPRI, 3412 Hillview Avenue, Palo Alto, CA 94304.

Research Report 1843-2, "Turbine Generator Fire Protection by Sprinkler System," July 1985.

E.1.2.8 FMRC Publications. FM Global Research, FM Global, 1301 Atwood Avenue, P.O. Box 7500, Johnston, RI 02919.

FMRC J. I. 0X1R0.RR, "Large-Scale Fire Tests of Rack Storage Group A Plastics in Retail Operation Scenarios Protected by Extra Large Orifice (ELO) Sprinklers."

E.1.2.9 IMO Publications. International Maritime Organization, 4 Albert Embankment, London, SE1 7SR, United Kingdom.

International Convention for the Safety of Life at Sea, 1974 (SOLAS 74), as amended, regulations II-2/3 and II-2/26.

E.1.2.10 NFSA Publications. National Fire Sprinkler Association, P.O. Box 1000, Patterson, NY 12563.

Valentine and Isman, *Kitchen Cabinets and Residential Sprinklers*, November 2005.

E.1.2.11 SNAME Publications. Society of Naval Architects and Marine Engineers, 601 Pavonia Ave., Suite 400, Jersey City, NJ 07306.

Technical Research Bulletin 2-21, "Aluminum Fire Protection Guidelines."

E.1.2.12 UL Publications. Underwriters Laboratories Inc., 333 Pfingsten Road, Northbrook, IL 60062-2096.

Commodity Hazard Comparison of Expanded Plastic in Portable Bins and Racking, Project 99NK29106, NC4004, September 8, 2000.

Technical Report of Fire Testing of Automotive Parts in Portable Storage Racking, Project 99NK29106, NC4004, January 5, 2001.

E.1.2.13 Uni-Bell Plastic Pipe Publications. Uni-Bell Plastic Pipe Association, 2655 Villa Creek Drive, Suite 155, Dallas, TX 75234.

Handbook of PVC Pipe.

E.1.2.14 U.S. Government Publications. U.S. Government Printing Office, Washington, DC 20402.

Title 46, Code of Federal Regulations, Part 72.05-5.

U.S. Federal Standard No. 66C, *Standard for Steel Chemical Composition and Harden*

Copyright NFPA

Ability, April 18, 1967, change notice No. 2, April 16, 1970.

E.2 Informational References. (Reserved)

E.3 References for Extracts in Informational Sections.

NFPA 33, *Standard for Spray Application Using Flammable or Combustible Materials*, 2007 edition.

NFPA 36, *Standard for Solvent Extraction Plants*, 2004 edition.

NFPA 37, *Standard for the Installation and Use of Stationary Combustion Engines and Gas Turbines*, 2006 edition.

NFPA 40, *Standard for the Storage and Handling of Cellulose Nitrate Film*, 2007 edition.

NFPA 82, *Standard on Incinerators and Waste and Linen Handling Systems and Equipment*, 2004 edition.

NFPA 99, *Standard for Health Care Facilities*, 2005 edition.

NFPA 101®, *Life Safety Code®*, 1997 edition

NFPA 214, *Standard on Water-Cooling Towers*, 2005 edition.

NFPA 307, *Standard for the Construction and Fire Protection of Marine Terminals, Piers, and Wharves*, 2006 edition.

NFPA 318, *Standard for the Protection of Semiconductor Fabrication Facilities*, 2006 edition.

NFPA 415, *Standard on Airport Terminal Buildings, Fueling Ramp Drainage, and Loading Walkways*, 2002 edition.

NFPA 423, *Standard for Construction and Protection of Aircraft Engine Test Facilities*, 2004 edition.

NFPA 430, *Code for the Storage of Liquid and Solid Oxidizers*, 2004 edition.

NFPA 804, *Standard for Fire Protection for Advanced Light Water Reactor Electric Generating Plants*, 2006 edition.

NFPA 805, *Performance-Based Standard for Fire Protection for Light Water Reactor Electric Generating Plants*, 2006 edition.

NFPA 850, *Recommended Practice for Fire Protection for Electric Generating Plants and High Voltage Direct Current Converter Stations*, 2005 edition.

NFPA 851, *Recommended Practice for Fire Protection for Hydroelectric Generating Plants*, 2005 edition.

NFPA 909, *Code for the Protection of Cultural Resource Properties — Museums, Libraries, and Places of Worship*, 2005 edition.

Formal Interpretations

Formal Interpretation

NFPA 13

Installation of Sprinkler Systems

2007 Edition

Reference: 8.15.9

F.I. No.: 13-99-2

Background: Section 8-5.6 states that the clearance between the sprinkler deflector and the top of storage shall be 18 in. (457 mm) or greater. Section 8.15.9 provides guidance on sprinkler protection of library stacks. This guidance allows floor to ceiling bookshelves and requires sprinklers to be installed in every aisle with a distance between sprinklers along aisles not to exceed 12 ft (3.6 m).

Question: Is it acceptable to apply the principles of NFPA 13, 8.15.9 to the storage of Medical Records on fixed open bookshelves, thereby allowing the tops of the bookshelves used for this purpose to come within less than 18 inches of the horizontal plane of the sprinkler deflector with sprinklers installed in every aisle?

Answer: Yes.

Issue Edition: 1999

Reference: 5-13.10

Issue Date: January 3, 2002

Effective Date: January 23, 2002

Copyright © 2006 All Rights Reserved
NATIONAL FIRE PROTECTION ASSOCIATION

Formal Interpretation

NFPA 13

Installation of Sprinkler Systems

2007 Edition

Reference: 11.2.3.1.8(1) and 11.2.3.2.3.1

F.I. No.: 13-02-1

Question No. 1: Is it the intent of 11.2.3.2.3.1 to permit the system area of operation to be reduced below the limits of Figure 11.2.3.1.1 (e.g., less than 1500 sq ft)?

Answer: Yes

Question No. 2: If the Answer to Question No. 1 is yes, is the intent to allow the density to be less than the limits of Figure 11.2.3.1.1 (e.g., less than 0.1 gpm/sq ft for Light Hazard) as long as the point was legitimately picked from the density/area curve and appropriately reduced per 11.2.3.2.3?

Answer: No

Question No. 3: Is it the intent of Section 11.2.3.1.4(1) to require the densities for 1500 sq ft for all applications, including when Section 11.2.3.2.3.1 is applied, when the final area of sprinkler operation is less than 1500 sq ft?

Answer: Yes

Issue Edition: 2002

Reference: 11.2.3.1.8.1 (1) and 11.2.3.2.3.1

Issue Date: March 9, 2004

Effective Date: March 29, 2004

Copyright © 2006 All Rights Reserved
NATIONAL FIRE PROTECTION ASSOCIATION

Formal Interpretation

NFPA 13

Installation of Sprinkler Systems

2007 Edition

Reference: 17.3.4.1.4

F.I. No.: 13-02-2

Question No. 1: Are the dimensions in Figure 17.3.4.1.4 intended to be the only acceptable combination of rack height, clearance, flue space width, rack length and rack width?

Answer: No

Question No. 2: Are other situations not shown on the figure, such as double row racks with a width of 9 ½ ft (4 ft loads with 6 inch longitudinal flue), a height other than 54 ft and a length greater than 24 ft allowed as long as they comply with the other rules of NFPA 13?

Answer: Yes

Issue Edition: 2002

Reference: 12.3.5.4.1.4

Issue Date: July 16, 2004

Effective Date: August 4, 2004

Copyright © 2006 All Rights Reserved
NATIONAL FIRE PROTECTION ASSOCIATION

Formal Interpretation

NFPA 13

Installation of Sprinkler Systems

2007 Edition

Reference: 22.4.4.8

F.I. No.: 13-02-3

Question No. 1: Can residential sprinklers of different orifice sizes be used within a compartment provided they have different directional discharge characteristics (i.e. pendent vs. sidewall)?

Answer: Yes.

Question No. 2: Can residential sprinklers of different orifice sizes be used within a compartment provided they have different thread sizes such that replacement cannot be confused?

Answer: Yes.

Question No. 3: Can residential sprinklers of different orifice sizes be used within a compartment without regard to discharge characteristics, thread sizes, or maximum protection areas?

Answer: No.

Issue Edition: 2002

Reference: 8.4.4.6

Issue Date: September 9, 2005

Effective Date: September 29, 2005

Copyright © 2006 All Rights Reserved
NATIONAL FIRE PROTECTION ASSOCIATION

[Click here to view and/or print an Adobe® Acrobat® version of the index for this document](#)